

DEBATTEN

THE HOUSE OF PHOTOGRAPHY

MSC04 ARC

GROUP 20

MAY 2021





ABSTRACT

This master thesis takes its basis in the open competition of a new museum of photography situated on the developing waterfront of the Bjørvika harbour in Oslo. To be more specific the southern point of Bjørvika called Sukkerbiten.

It is evident the social interaction has a positive influence on the physical and psychological health. Therefore, the museum development must attract a wide array of visitors.

The rural area beacons with cultural landmarks, such as the Edward Munch Museum and the Oslo Opera. The addition of the photographic museum must then finalize the cultural development on the Bjørvika district, and in harmonious relation to the existing structures develop a gathering point of multiple generations in formal and informal processes.

The museum becomes a transformation of the traditional museum typology by breaking the elitist perception of art while establishing transparency to the city and becoming an educational institution for

multiple user groups. The purpose of the museum is to expose the users to the socially relevant subjects, be it war, racism, sustainability, body positivity, etc., and allow the users to gather an opinion on the sorts, thus creating room for debate and discussion. This becomes the fundamental purpose of “Debatten - Fotografihuset”

Conceptually, the museum of photography creates its monumentalism and recognisability through its wide reach and low height in comparison to the pylon monumentalism present in the close context. The museum then becomes a gathering point at eye level, with human scale in focus when designing the connectivity between interior and exterior spaces.

TITLESHEET

AALBORG UNIVERSITY
DEPARTMENT OF ARCHITECTURE, DESIGN & MEDIA TECHNOLOGY

PROJECT TITLE	DEBATTEN
PROJECT GROUP	20
SEMESTER	MSC04 SUSTAINABLE ARCHITECTURE
SUPERVISOR	LARS BRORSON FICH
PROJECT PERIOD	FEBRUARY 1ST - MAY 27TH
NUMBER OF PAGES	199
ANNEX	15

KARIN WSHYAR DARBANDY

MAGNUS HARRESKOV MAAGAARD KRISTENSEN

MIKKEL MØLLER TIMMERMANN

READING GUIDE

The report contains illustrations and text concerning the development of the House of Photography, and the analyses prior to this. The report is divided into 6 chapters, respectively introduction, analysis, design strategies, design process, presentation, and recapitulation. The chapters are further divided into sub-chapters, which are identified below the headings of the various subjects. The design strategies chapter sums up the analysis and redefines multiple aspects of the analysis into feasible strategies. The integrated design process, hermeneutic learning approach and design considerations will be investigated during the design process chapter. The presentation chapter presents the finalized design proposal through visualizations and diagrams. The recapitulation chapter contains a conclusion on the problem statement and vision, while the reflection covers thoughts and considerations to the finalized proposal.

The site of Sukkerbiten, Bjørvika, Oslo is rotated 20 degrees northwest, and the plan sections shown in the report will be presented with true north rotated 20 degrees.

Enclosed to the report is a drawing folder of a masterplan in 1:1000, plan drawings in 1:200, elevation drawings in 1:200, section drawings in 1:200, and detail drawings in 1:20.

The references through the report are made with the Harvard reference method, and the literature list will be present after the recapitulation chapter. The references which are placed last in the sentence are validating for the sentence while reference placed last in the paragraph are validating for the whole paragraph. Illustrations are numbered in the order they appear in the report e.g, Ill. 12. Name of the illustration. The illustration list is placed in the recapitulation chapter.

TABLE OF CONTENTS

00 - INTRODUCTION

Motivation	9
Introduction	10
Methodology	12
The House of Photography	15
The photograph	16
Nordic architecture	18
Sustainability	20

02 - DESIGN STRATEGIES

Function diagram	73
Atmosphere diagram	75
Room programme	77
Atmosphere programme	80
Museum usage time	86
Design parameters	88
Vision	90
Exhibition narrative	91

01 - ANALYSIS

The city of Oslo	23
The new Fjord city	24
Access to the site	25
Volume studies	26
Material mapping	28
The urban areas	30
Climate changes	32
Social interaction and the influence on health	34
The exhibition potential	36
Atmosphere	38
Urban spaces and harbour renewal	40
Designing for disassembly	42
Timber constructions	44
Energy consumption	46
Indoor climate	48
Study of materials	50
Study of envelopes	52
Study of wood	56
Identifying the user and non-user	58
The staff	61
Interview with PixlArt	62
Houses of Photographies	64
Case studies	66
Analyses sub-conclusion	70

03 - DESIGN PROCESS

Introduction	93
Phase 1	94
Phase 2	104
Phase 3	114
Phase 4	122
Phase 5	134

04 - PRESENTATION

Masterplan	145
Plan drawings	148
The concept	150
Contemplation areas	152
The multiroom and blackbox	154
Zone detailing	156
Flow detailing	158
Elevation drawings	160
Section drawings	164
Urban areas	166
Material palette	168
The supporting structure	170
Designing for disassembly	172
Detail drawings	174
Energy considerations	178
Indoor climate	180
Daylight analysis	182
Ventilation	184
Fire strategy	185
DGNB certification	186
LCA results	188

05 - RECAPITULATION

Conclusion	191
Reflection	192
Literature list	193
Illustration list	196

06 - APPENDIX

Appendix 1	201
Appendix 2	202
Appendix 3	203
Appendix 4	205
Appendix 5	210
Appendix 6	214



00 INTRODUCTION

MOTIVATION

The motivation for choosing this topic of an exhibition center, comes from personal interest in developing cultural landmarks and challenging the prejudice of exhibition centers being for the elite.

The goal is to design a cultural, publicly accessible building which alters the perception of museum elitism. We wish to investigate whether the physical environment and potential of a cultural building can become a significant part of the development of social ties and relationships, especially with a focus on user groups who don't usually generate ties. We aim to challenge ourselves and thereby attempt to use our accumulated knowledge and skills gained from education, to design a physical environment that supports the given function of the cultural building, while also supporting the development of the city and social relationships through architecture and urban developments. We wish to design from sustainable principles, with focus on environmental, and social sustainability while also exploring the possibilities of expanding the building's time of use beyond the initial intended purpose. Our motivation was met with the design brief of an open architectural competition which revolved around the establishment of the House of Photography.

It becomes a modern approach to exhibition design with its architecture, urban development, restaurant and workshop offers supporting the development of the new Oslo Fjordby. The House of Photography also serves to complete the cultural cluster together with the Opera and the Edward Munch museum.

It aims to bring international photographers to Norway and showcase Norwegian and Nordic photographers and their work to an international audience. The exhibition center will act as an arena for education and enlightenment, rather than as a traditional museum.

Problem

How can we develop a building for House of Photography where they can host exhibitions and facilitate social possibilities for Oslo's residents? The municipality emphasizes that the location must assist in developing a good city in relation to their visions of the harbour front renewal in Oslo, and they require that the urban areas and the transparency of the facades must support this claim. The building must further support and facilitate possibilities of education, entertainment, and enlightenment, while being flexible in its future usage and possibilities through plan alterations.

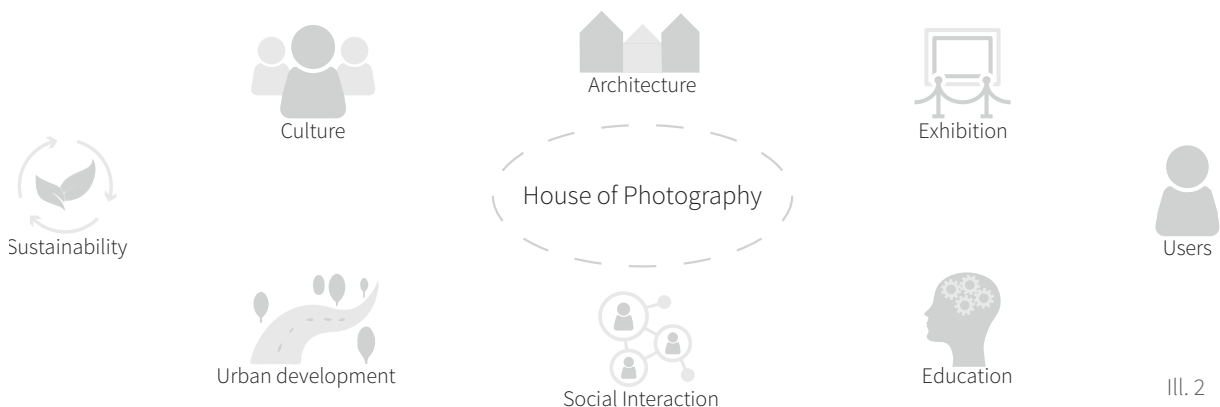

INTRODUCTION

This report presents a proposal for the completed international competition of developing a new House of Photography for the company “Fotografihuset” in Oslo, Norway. Despite the competition being concluded, the construction has not begun on site, due to Covid-19 and negotiations delaying the process. The site is located at a peninsula named “Sukkerbiten” which is an extension of the existing Bjørvika district. The designated area is sectioned into different land registration numbers, where the primary House of Photography is to be located at A11, with recreational urban development in A11 and A36b. A36a,c,d are intended to become coastal protection areas intertwining with urban development and creating opportunity for stay. The land register A10 hosts a secondary exhibition building with light food, and a clear reference to the city beach to be implemented at A21.

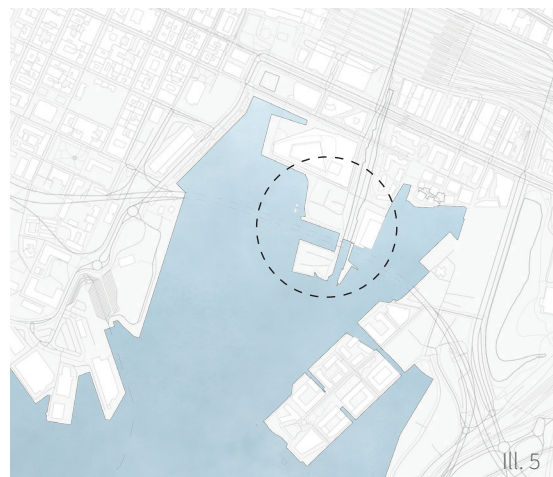

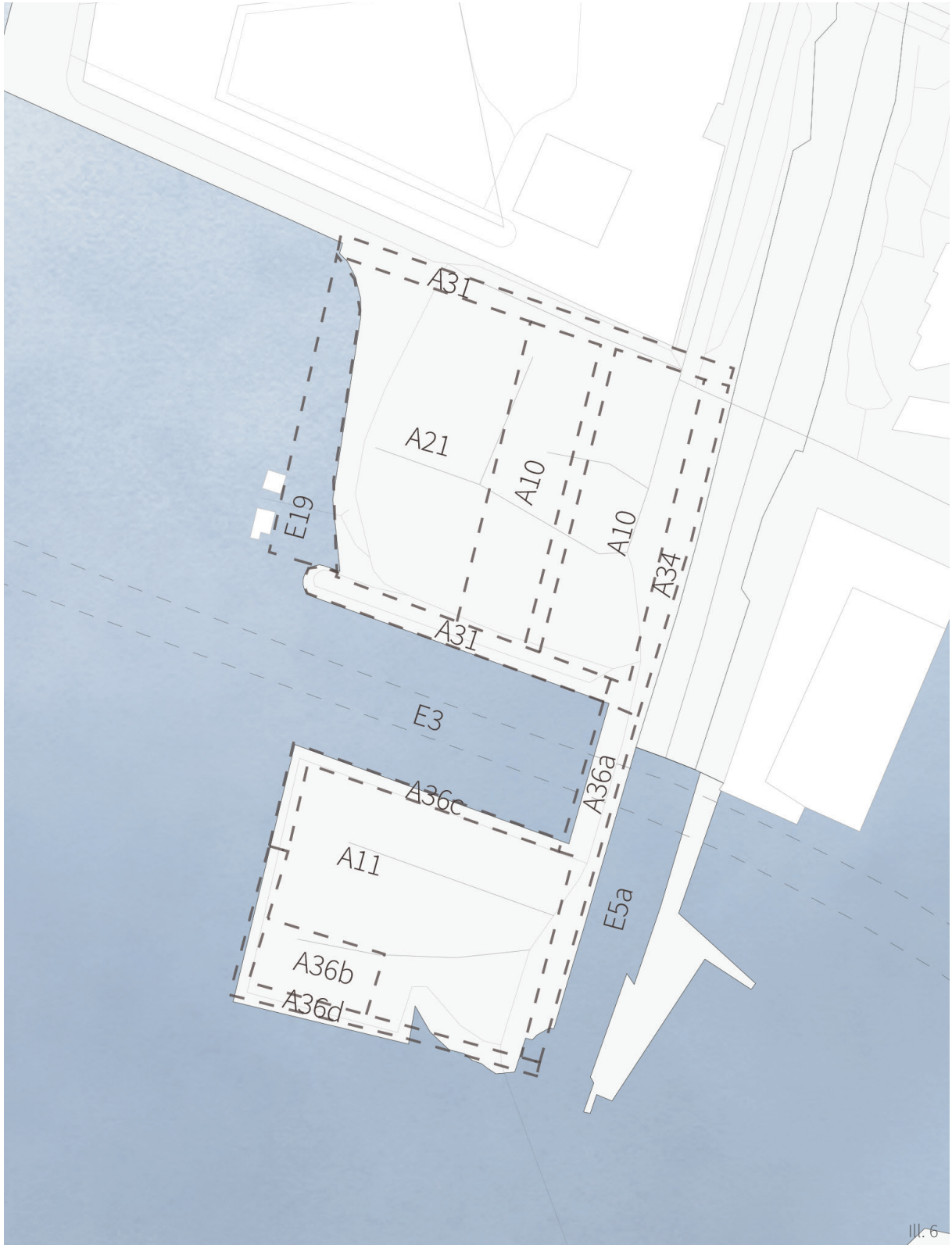

III. 6

METHODOLOGY

The overall theoretical standpoint in the development of this project has been the integrated design process. A topic practiced especially at the academic environment of Aalborg University, where the working method revolves around the hermeneutic approach to learning theory.

The integrated design process is divided into five sections: problem, analysis, sketching, synthesis, and presentation (Knudstrup, 2004). And the hermeneutic approach ensures that the working method is going back and forth between the various phases based on the new knowledge acquired from a certain task.

Problem

This phase indicates the requirement of a certain problem, the reason the project began and indicates a goal. In this case, the problem at hand will be to design the new House of Photography based on their visions, our analysis and theoretical knowledge of how to implement technical-, constructional- and aesthetical assets to create wholesome and holistic architecture for the client.

Analysis

To create a basic framework and to direct the design process, certain analysis will be done, in order of compiling adequate information to instigate a qualified design direction. It is often beneficial to analyze subjects which contribute to the understanding of the character of the site, the user, construction principles, sustainable potential of the building and the impact the building could have on sociocultural aspects.

Various sorts of analyses will be done, and each method creates different outputs necessary for the design process.

- Site analysis
Predominantly phenomenologically structured to capture the character of the site and mapping materials, investigating grid lines and the natural framing potential the building can have. Currently the situation with Covid-19 makes it harder to visit the site, which is located in Oslo, Norway. Therefore, the predominant structure of this project will be performing cartographic site analysis. Here among, infrastructure, function mapping, material mapping, city development plans and climatic conditions.
- Theoretical analysis
Some topics are not specifically related to the site or the building. However, to create architecture which can have a sociocultural impact, some theories will be investigated in order to create a basis of the development. Topics to investigate include the relation between social interaction and health, and the atmosphere of various materials and settings.
- Engineering analysis
Architecture is the construct of harmonious relations between the aesthetical, the constructive and the technical subjects. The engineering subjects must be analyzed for their potential in improving the architecture as a whole. Topics to investigate consists of construction principles, the environmen-

tal impact, modular architecture, energy consumption, indoor climate and DGNB.

- User analysis
Designing architecture specifically to a client requires the involvement of said client into the design process. Furthermore, when designing a public accessible building as the case is with House of Photography, it also requires knowledge of the everyday working staff, the visitors of the exhibition center and the photographers. To attain the knowledge, a combination of quantitative and qualitative academic literature and interviews will be made. The users, the non-users, the photographers, and the client are investigated as subjects.
- Inspirational analysis
Inspiration will be used to examine existing, different, and solid solutions to problems comparative with this project. This gives an idea of a design direction before the design process necessarily begins. Casestudies of buildings with either similar purpose, certain constructive principles, aesthetic composition, legibility, or functionality will be examined and evaluated into design assets for this project.

The analyses will be developed throughout the project and are made to assist the design process while sketching. Thereby applying the hermeneutic approach where some sketches require additional analysis to be done before being valid.

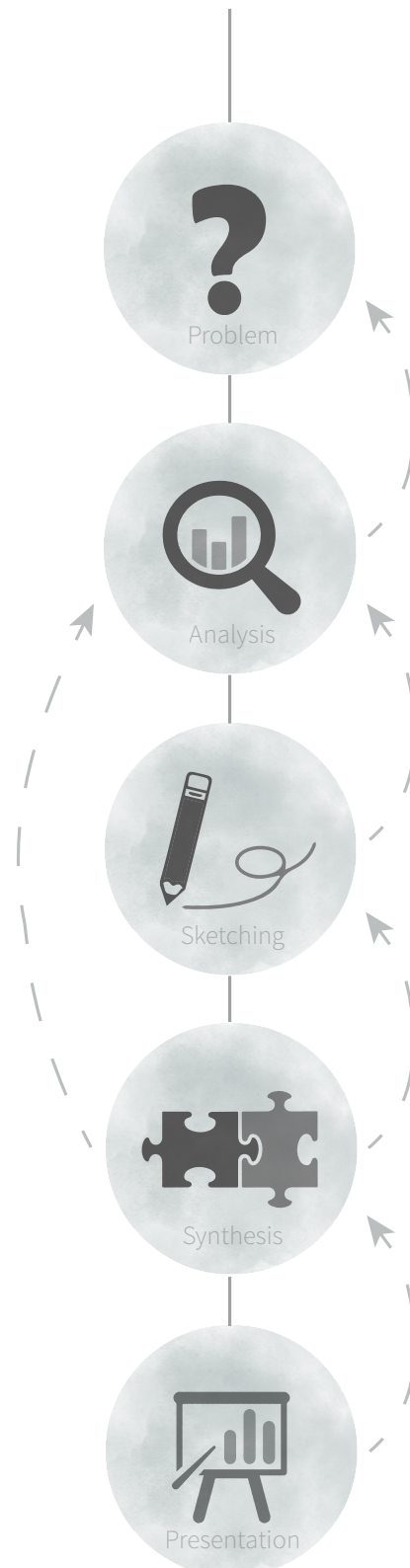

III. 7

Sketching

The design process is compiled of various sketching methodologies. The initial design process consists of volume studies to quickly investigate size, shape, orientation, volume/surface ratio, and spatial creation. Primarily the method of analogue sketching will be utilized at the initial phases of concept development and spatial layout, and digital sketching will be the main method at a detailing level. The academic internship provided in the 3rd semester of the master has taught us, as a group, various things of how the practical environment differs from the academic environment. There was a large focus on qualifying the sketching proposals with DGNB criteria while sketching, along with possible validation checks from the building constructors and engineers. However, our academic background enables us to also be able to incorporate these engineering aspects when validating the design proposals. Through the evaluation of the various design proposals, a consistently stronger concept and solution comes to show, with well argued solutions, compositions, and narratives. The design proposal must investigate multiple aspects at once to create holistic and integrated design.

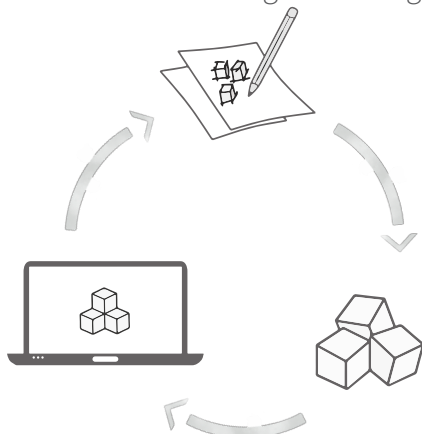

III. 8

Synthesis

The ability to synthesize the various proposals is a strength of the integrated design method. Through computer simulations and design criteria and analysis, a design proposal will be evaluated as a proper solution or requiring additional work. This project includes the tool BE18 to verify the energy conditions of the design proposal, as well as include hand calculations of certain critical conditions regarding indoor climate, and Velux Daylight Visualizer to indicate the amount of daylight in specific exhibition areas and office environments.

Presentation

The results of the previous phases and aspects are communicated through text and illustrations in a report, the annex, and a drawing folder. The project will be conveyed and presented at an oral exam, with a building model 1:200, a context model 1:1000 and posters to recapitulate the important aspects of the project. To present the process, working sketches and models will be utilized in communication principles and design thoughts. The material for the presentation phase will be developed in following programs:

- Autodesk AutoCAD
- Autodesk Revit
- Enscape for Revit
- Vray for Revit
- Adobe Photoshop
- Adobe Illustrator
- Adobe InDesign

THE HOUSE OF PHOTOGRAPHY

Our society has integrated photos into everyday life for instance, at work, social events, and home. Photographs have a strong communicative strength, extraordinary artistic expressions and are strong journalistic weapons. With mobile phones, and social media, the use of photographs has increased extremely. People worldwide take more than one billion photographs every year and everyday hundreds of millions of photographs are uploaded on various social media platforms. Therefore, you can say that photographs act as a social glue and a fantastic artistic means of expression.

Photographs have a unique power to touch and evoke emotions and unfortunately, they can be used for propaganda and fake news. Therefore, it is a battle zone where aesthetic and ethical attitudes are formed and challenged. In recent years the popularity of exhibition of photographs have increased for instance at photography museums in New York, Paris, Amsterdam, Berlin, and Stockholm. The new photography house in Oslo will be an addition to the internationally known museums (Fotografihuset, n.d.).

The House of Photography desires to be an organization that makes exhibitions with Norwegian and international photographers and they pursue to reach a wide audience. The organization supports and presents photographers to the audience to promote the importance of photographs. The museum will present and discuss photography as a social phenomenon and artistic expression. The house of photography has the following vision for the new

museum.

- To create high-quality audience and learning experiences in temporary premises until the permanent premises are established.
- To cultivate strong and productive relationships with the political environment, the business community, the local community, and the photo community, in Norway and internationally.
- To develop public, private, and own sources of income, and to act financially and administratively responsible.
- To contribute to an ethical and economically sustainable development of the cultural city of Oslo (Fotografihuset, n.d.).



Ill. 9 Credit: Fotografihuset



Ill. 10 Credit: Fotografihuset

THE PHOTOGRAPH

Photographs and paintings are two mediums of projecting reality into a visual frame. They can show the same motive, and they can have the same color schemes, but they will be very different in their portrayal. The photograph is a realistic portrayal of the motive, whereas the painting can have a larger degree of artistic freedom (Yeung, 2013). The largest difference between the painter and the photographer is that the painter composes the painting from an empty canvas with his own visuals and agendas, where the photographer organizes and puts structure into the photograph through framing and selective processes when capturing reality, which is his filled canvas (Shore, 2011).

The photograph will remain a perfect visual representation of a given event, but the agenda behind the photograph can be determined beforehand with the framing. The purpose of introducing a house of photography can further be by educating the public into establishing a critical mindset to what is displayed in the media. This is done through the education of manipulation with workshops and possibly exhibition thematic. In terms of manipulating settings to induce critical mindsets, French photographer Noemie Goudal often implements two dimensional elements such as cardboard into her three-dimensional spaces. She mentions that when a photograph is printed, everything becomes two dimensional, and this introduces the visual representation of a non-existing space, which becomes an artistic degree of freedom that can warp the perception of reality within the space (Goudal, 2016). This inducement of critical thinking enab-

les the House of Photography to become a pivotal socio-cultural landmark in the education of public critical mindset. The photograph can illuminate the detail that human perception cannot. Andreas Gursky has spent the majority of his career exploring the utilization of multiple photographs edited into one photograph, to increase the detail level and let the photograph be the perfect representation of the reality not even human eyes can perceive. When perceiving a photography, one will most likely notice those small details and mistakes, which are hidden when looking at the actual thing in reality (Gursky, 2018).

Photographs can tell stories and move us to compassion and to open our eyes to the world that surrounds us. According to the Pulitzer-prize winning photojournalist Renée Byer photojournalism has the power to inform, educate and bring understanding to issues. Our world is a fast-paced world where the emphasis is on immediacy therefore a photograph can stop time and make the viewer think, react, and feel (TEDx Talks, 2010). The photograph can transport us to worlds we have never experienced before. It has the ability to educate us without directly having to experience lessons for instance about loss, leadership, war, conflict, and love. You can therefore say that the photograph challenges us and makes us go beyond the surface and our perspectives (Peterson, 2017). Around the world there are several prizes and awards for photojournalism where photographs are praised and honored for their messages they spread. The power of photography is tremendous and often plays a large role to display messages.

Previously the photograph was a media mainly produced by photographers for exhibitions, and people who wanted to experience it, actively went to an exhibition. Modern times have cell phones and social media where pictures are being shared constantly, thereby no longer requiring an active approach. The modern times reflect that the quality of the pictures have faded in order for quantity to rise. The House of Photography must redeem this aspect and once again make photographs exquisite pieces of artwork, worthy of exhibition.

The Covid-19 Pandemic unfortunately forced a lockdown which canceled or postponed many events and exhibitions. But as the lockdown continued many organizations and museums tried to challenge the norm of exhibitions. They reviewed their events to offer digital and online possibilities. For instance, some museums have

had virtual or outdoor exhibitions or lectures on an online platform. A local example is PixlArt who travelled around Northern Jutland and created exhibitions for people at nursing homes. The exhibitions were placed outdoors, and the residents could see it from their rooms and common areas. The online events have an economical benefit and the host can save up to 95% of their expenses. Also, since the market is changing, a wider audience is approached. People who could not make it before due to transport or work, can now attend virtually. And at the same time, we must be careful to not lose the human connection and what the physical experiences offer us. But it is inarguable that we will see a change in our behavior and society because of the social distancing. Therefore, it is the architects and designers' job to avoid flows in museums that cause bottle necking and close human contact (Lincoln, 2020).



Ill. 11 Credit: Noemie Goudal



Ill. 12 Credit: Andreas Gursky



Ill. 13 Credit: PixlArt

NORDIC ARCHITECTURE

Nordic architecture as an architectural style was not invented before the 20th century. Prior to this rise, the architecture within the nordic countries was a mix and match of various architectural styles from around the world. The style arose around the 20th century change, where architects of the north refused to implement the existing architectural styles, and settled on developing a new image with the new technological advancements (Reuben, 2019).

Nordic architecture is functional and attractive buildings in a minimalistic style. The architectural style cherishes solutions that optimize and create good living spaces, for instance, maximizing the natural light and heat during long winters in the far northern countries. In general, the buildings are made of wood, stone, and brick with an emphasis on local materials and skills. The architecture in Norway is similar to the architecture in Sweden, Finland and Denmark, but in Norway, wood is one of the primary building materials and defines the identity of the Norwegian architecture. The architectural company Snøhetta raised Norway's architectural profile with many extravagant buildings but one of the most popular designs is the Opera House in Oslo where they designed the entire interior with wood and glass. Snøhetta implemented this concept in other projects, such as Vennesla Library and Cultural Centre in 2011 (Reuben, 2019).

Nordic architecture is implementing elements which address the surrounding nature. Nordic architecture is about integrating natural materials, natural light, neutral colors in a minimalistic and simple

design. Often the building design has large windows to allow as much natural light as possible into the building. Construction made of wooden elements are often utilized to adapt to the environment. The interior of the Nordic architecture emanates a warm atmosphere in terms of using warm materials such as wood or warm colors, trying to avoid concrete and cold colors. The purpose of the latter is to construct a contrast to the long and cold winters in the Scandinavian countries. The interior of the Nordic homes are simple, clutter-free, and as natural and warm textiles as possible (Hanson, 2019).

According to Tanja Rytönen, it is possible to describe Nordic architecture in five points, integration with nature, simplicity in design, utilization of natural light, creative use of natural materials and functionality and comfort. The natural material and the nature is a big part of the Scandinavian life and is close by in urban surroundings. When describing Scandinavian architecture it is about designing a simple building with clean lines, basic shapes, solid and natural colors with clean details and no unnecessary "decoration". She also describes modern timber technology in five points, visual freedom, flexibility of design, high technical quality, quick construction, and healthy and safe buildings (Rytönen, 2017).

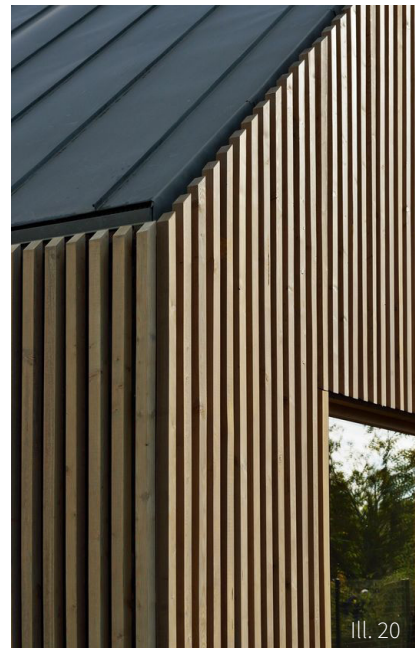
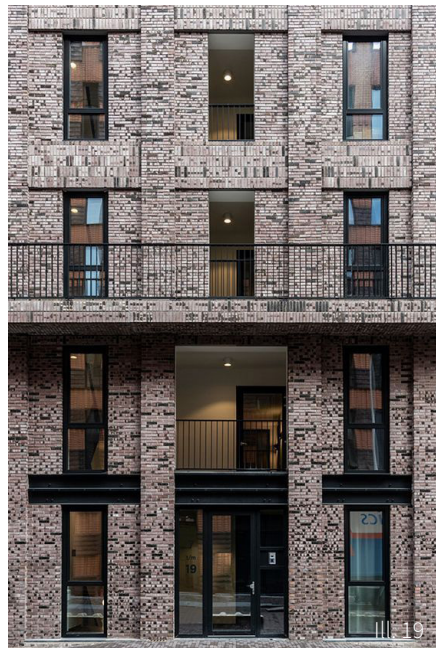
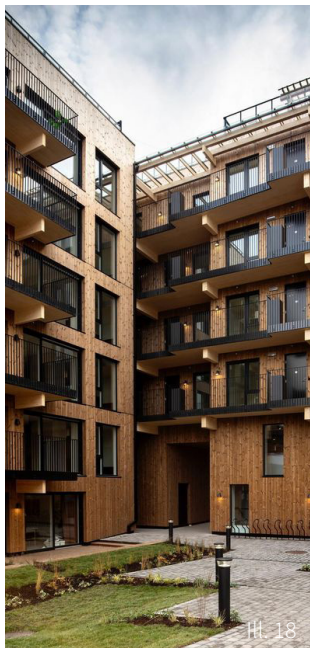

SUSTAINABILITY

Sustainability is defined by maintaining the balance of the world's resources between the consumption and the production of raw materials. The general consensus of sustainability is that it is built up by three fundamental pillars such as economic development, social development, and environmental protection. If any of the three pillars are weak within a development, the entire sustainable structure decays (Mason, 2021).

Economic sustainable developments can be classified into micro and macro scale. Micro scale revolves around circular economy, cradle to cradle and performing Life Cycle Cost (LCC) analysis of the concept, in order to investigate which solution is the most beneficial over a period of time. The LCC analysis also relates itself majorly to the environmental assets through considerations of maintenance. In this project micro scale economic sustainability can be seen through the extensive research into flexible plans to ensure the reuse of the building in case the House of Photography cannot sustain themselves, and Hav Eienomme wishes to sell the building. Macro scale economic sustainability revolves around ensuring the proper salaries are paid to the workers harvesting, producing, and transporting material to the building site and the project. Certain certification tools assist in identifying economic, social, and environmentally sustainable production facilities. Some of these certification tools could be FSC or Fairtrade.

Social sustainability can be hard to define since it relates itself to cultural events and the generation of social ties, avoiding

singled out communities and in general considers the living conditions of societies. Recent years involve much research into the topic of social sustainability, and one such researcher is Marie Stender, who visited Aalborg University and held a lecture during 2020. She visualized a 12 criteria diagram which ensures that the designer considers social sustainability in the development of a concept. The 12 criteria are divided into three topics of Social cohesion, participation and opportunities for everyone which will be explained further in the report. In conclusion, social sustainability cherishes the safety, generation of social ties and living qualities for the users within a given physical environment (Stender, 2020).

The environmental protection topic revolves around preserving the resources the Earth contains. A large global issue is the emission of carbon dioxide and similar ozone degradable toxins, which will be further described later within the report. A large portion of the emission comes from energy production and the building industry. Globally coal and oil are the materials used in 45% of the energy produced, with renewable resources covering 36% (IEA, 2020). The increased focus on indoor climate and energy consumption within the individual buildings aided in reducing the overall emission produced per house, especially within operation. The large improvement in operational emission however, showed that the material usage becomes the main emitter within a house (Hellwig, 2020). This project therefore, will focus on material emission and consumption with considerations to circular usage

and end-of-life stages through extensive Life Cycle Assessment (LCA) analysis and verifications.

DGNB as a sustainable verification

To investigate the sustainable quality of a project, a certain certification tool will be utilized. DGNB consists of six categories, which in cohesion develops the potential for a sustainable building proposal, process, environmental, economic, social, technical and site qualities. Each of the categories contains various subcategories, concerns and questions which provides weighted points if documented. Environmental, economic, and social have a higher weight than technical, process, and

site qualities. In Denmark the minimum requirement of public builds is to achieve the Silver DGNB certificate, which means an overall score of 50% with a minimum 35% score in the main four categories. This will also be the basic requirement of this project, with an aim of achieving a potential Gold certificate with overall 65% and 50% in main four criteria or Platinum certificate with overall 80% and 65% in main four criteria.

Furthermore, The DGNB verification has been in expanded in 2020 with a heart certification. The new addition focusses on the indoor climate and user control. The certification is also divided into three silver, gold and platinum (DGNB, 2021).



01

ANALYSIS

THE CITY OF OSLO

1.1 SITE ANALYSIS

Oslo is the capital of Norway and the biggest city with approximately 1,000,000 inhabitants. The city is a cosmopolitan focal point of outstanding architecture, museums, restaurants, and shopping. The opera house, the Munch museum, and the Bjørvika district, which are marked on the diagram below, are excellent landmarks either by the buildings or the urban space and they tend to uplift the quality of the city. The development of Oslo and the cultural buildings indicates that the council of Oslo has a desire to invest in the social settings and the cultural life.

Oslo is a cultural destination with operas, ballet concerts, theaters, choirs, and festivals. The aim is to have an active cultural life throughout the year but especially during summer the cultural life is easily spotted in the city for instance, live outdoor concerts are very common. Reports from 2019 show

that the inhabitants and tourists use the cultural possibilities frequently for instance approximately 2.2 million have been visiting the theaters and operas in Norway and the Norwegian museums have had around 10.4 million visitors throughout the year (Statistisk sentralbyrå, 2020). Also, the public library Deichman Bjørvika has 2 million visitors where the Dokk1 in Aarhus has around 1,35 million visitors annually (Jyllands-Posten, 2018).

The House of Photography aims to have around 250,000 visitors annually therefore they indicate they will become a popular destination. In recent years the architectural development has risen and throughout the years Oslo has become a very attractive destination for tourists. Therefore, it is essential to focus on how the new building can adapt to a culturally rich area and become an attraction (Visit Oslo, 2021).

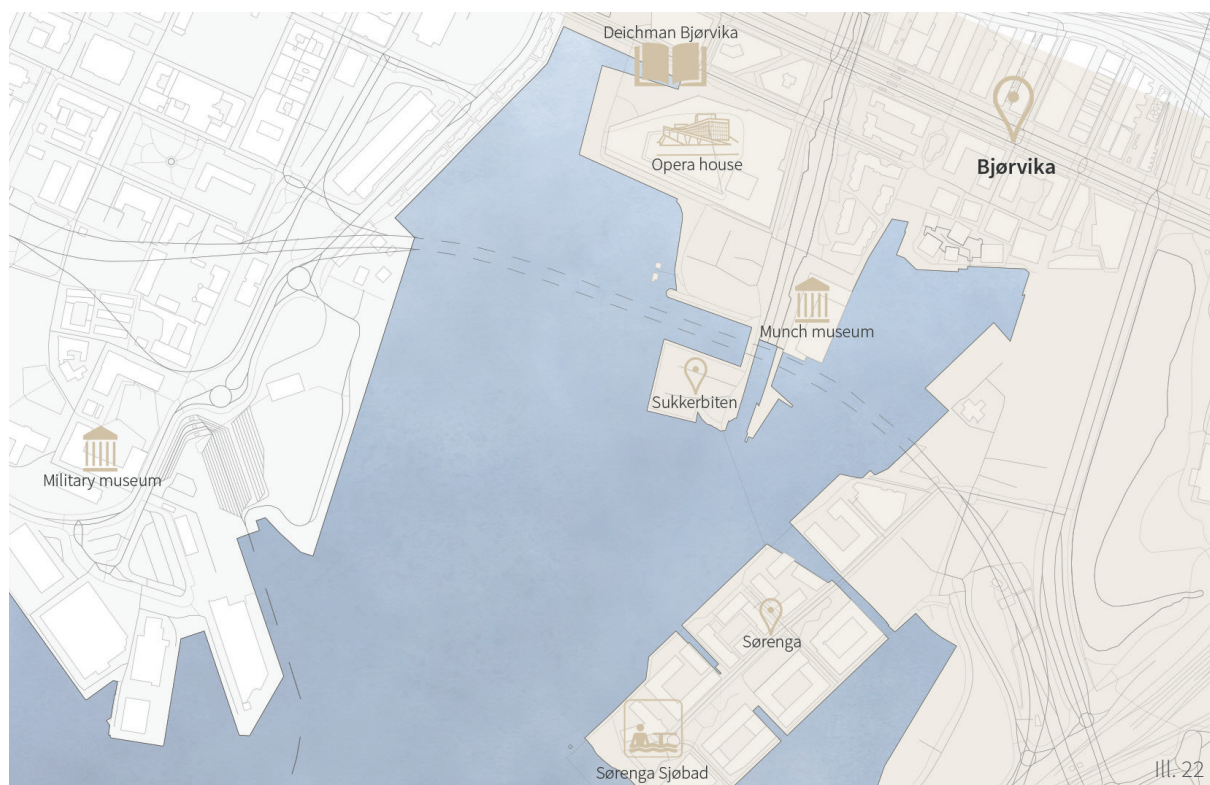

THE NEW FJORD CITY

1.1 SITE ANALYSIS

The Fjord city programme is an urban project which concerns the renewal of the waterfront of Oslo. The harbour is nearly 10 kilometers long and it will become one of the world's longest walkways. Previously the harbour was dominated by industry, shipyards, ports and highways but in 2008 the city council determined to transform the area to museums, art venues, offices, apartments, shopping, restaurants and recreational areas that will both benefit visitors and residents. The new area will give exceptional views of the fjord and flourish with public activities for instance, swimming and fishing areas. The transformation is in progress and is hoped to be one of Oslo's most beloved features (Nordregio, 2018).

The local plan defines criteria and certain directions to a given site. This plan is designed to fulfill the overall demands and

expectations for the municipal plan, which ensures that the individual sites and their buildings feel united in improving the development of the city. The following points are an extract of the local plan for Sukkerbitten (Oslo kommune, 2014).

- Materials used in the project must have long life cycles, and have the possibility of getting reused, and should furthermore not have negative influence on the indoor environment.
- The exterior and interior surfaces must be low resource intensive to maintain.
- The building area must not exceed 3.700 m² on A11 and 1.000 m² on A10.
- 50% of the roofs must be covered in greenery.
- 40% of A10 must stay untouched and unbuilt.



III-23

ACCESS TO THE SITE

1.1 SITE ANALYSIS

The project sites do not have dense traffic therefore the following analysis will focus on how to access the site since it is relevant to determine how and from which direction people arrive at the project site. The compactness of the central district makes it easy to explore the city on foot and the effectiveness of the public transport gives the opportunity to explore the city without a car (visitnorway, n.d.). The site of Sukkerbiten is located strategically with a clear view from the ferry and flight, which indicates that the House of Photography must relate itself with an open and inspirational facade with urban development towards the south. Looking upon Sukkerbiten and the entrance towards the site is it accessible by walking or bicycle from the south and east side on A11, where it is possible to enter A10 from north, east, and the Opera house. The absence of the hard traffic from the cars eases the atmosphere and allows

for the creation of urban development with focus on developing social relations and established transparency within the building concept.

Sub-conclusion

The analysis shows that the site is only approached by vulnerable road users therefore the design proposal must focus on accessibility for pedestrians and bikers. However, the competition demands accessibility for stock delivery therefore during the design process a solution must be compiled in order to diminish inconveniences for pedestrians and bikers. The placement of the site obligates to focus upon the connection between the site and the Opera house, the Munch museum and the Sørenga area. The museum must have an architectural visual impact towards the south to act as a point of interest for the tourist arriving by ferry and by flight.



Ill. 24

VOLUME STUDIES

1.1 SITE ANALYSIS

From a cartographic approach, it becomes evident that the surrounding close context to Sukkerbiten, Oslo consists of tall buildings. The Oslo Opera, the Edward Munch Museum, and the Deichman library are within the range of 40 to 60 meters. The remaining context consistently represents buildings of at least 20 meters with a high urban density. The effect of walking between the relatively narrow streets, surrounded by massive volumes induce fast pacing, quickly transforming the streets into transit areas with few possibilities to stop and breathe.

The buildings in the closest proximity to the designated site are the Oslo opera and the Edward munch museum. Both the mentioned buildings have heights above 40 meters and are of large areas. These

buildings have the significantly largest influence on the development of the house of photography. Furthermore, they are buildings that create their monumentality and recognizability through their pattern-breaking architecture, which enables them to become unique buildings in the city.

Sub-conclusion

With the close proximity consisting of buildings with large heights, the streets emanate transit and movement. The site has the potential of developing its character as a destination by hosting buildings that break the structure of the close proximity. The structure can be broken by developing a building with low height to relate itself at eye-level to the visitors.

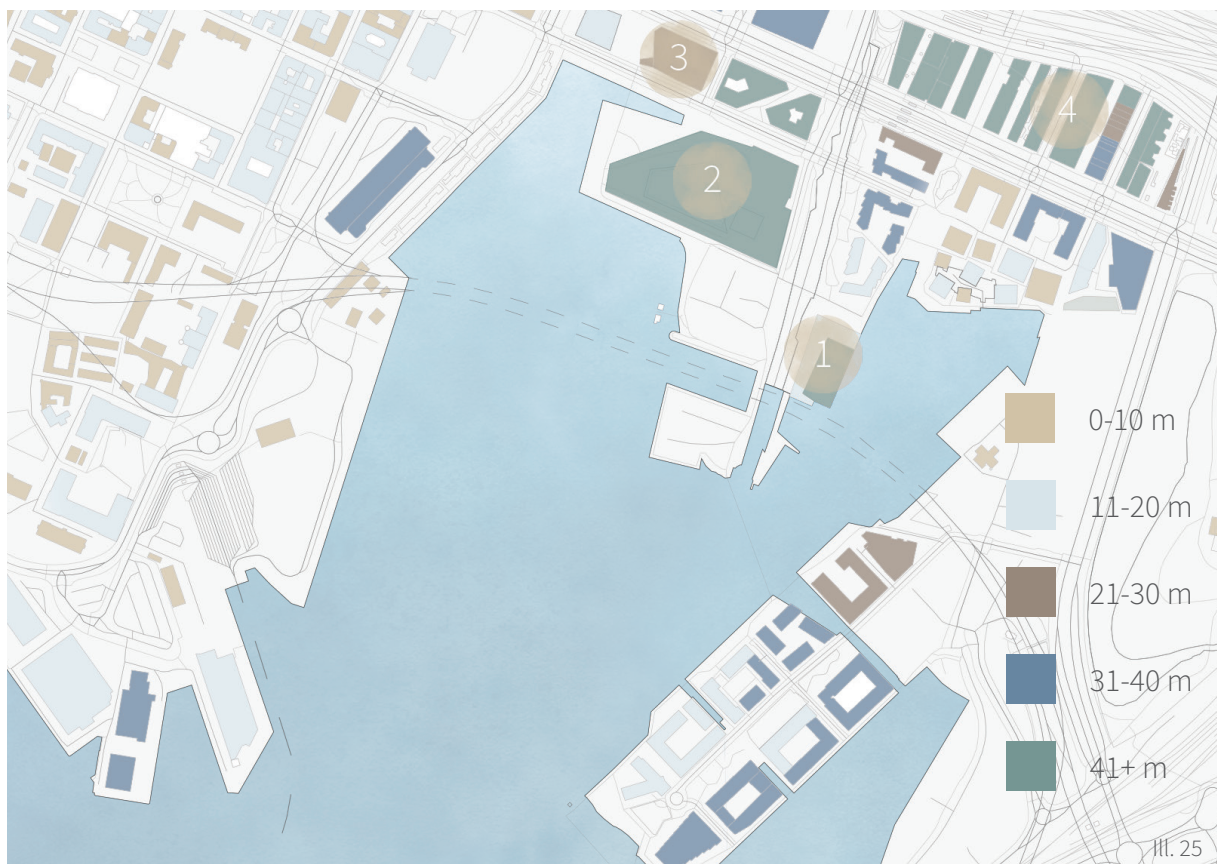



Ill. 26 Credit: Guttorm Johansen



Ill. 27 Credit: Arvid Malde



3

Ill. 28 Credit: Einar Aslaksen



4

Ill. 29



4

Ill. 30 Credit: Ørn Borgen

MATERIAL MAPPING

1.1 SITE ANALYSIS

Throughout the past 10 years Oslo new fjord city has been under development and especially the Sørenga area at Bjørvika have been transformed from an industrial area to a residential area. The aim is to establish a relationship between the new buildings and therefore, some materials are often used. The majority of the building facades are made of bricks or formwork of bricks and to ensure the individual identity of the buildings, various colors have been used. The cultural buildings have the similar materials for instance metal and glass facades but still they ensure to create their individual identity and character. For the urban areas mainly corten steel have been used for vegetation and hard surface materials of concrete or gravel in the traveling areas.

In other parts of Bjørvika the character is different since there are a large amount of baroque buildings, which contrasts the new development.

Sub-conclusion

The majority of the buildings in the Bjørvika area are made of brick, formwork of brick and metal with glass panels, but even though the buildings may have common material they intend to create their own character. Especially the cultural buildings aim to create an identity by their looks and choice of material. And while some may be a direct contrast to the residential area, the buildings are still capable of fitting into the area. This shows that during the design process the context does not create any barriers in form of the choice of materials instead there might be some environmental issues which will be analyzed later in the report. The context contains several landmarks therefore it may be necessary to create a cultural building that individualizes itself by the choice of materials.



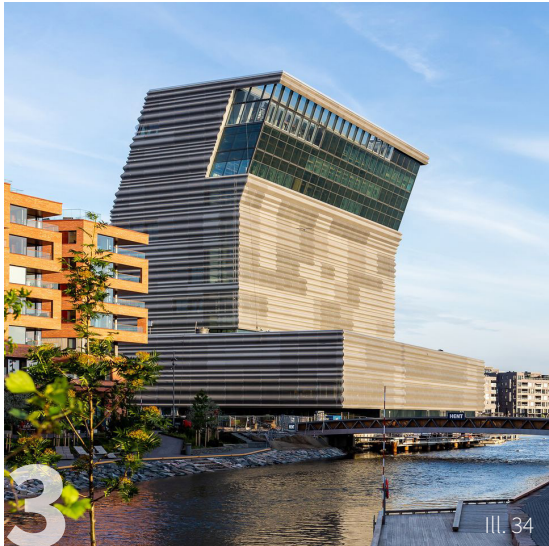

THE URBAN AREAS

1.1 SITE ANALYSIS

Oslo is a city with unique possibilities of both rich cultural and nature life which is also why the city was handed the title of European green capital of 2019. Sustainability and greenery have become a major focus point of the country and especially Oslo. The city has throughout the years transformed into a capital that focuses on green development.

The green development of the city is easily spotted by the activities for both citizens as well as tourists. The harbour front which used to be dominated by railways, highways and containers is now going through a large transformation, which is also explained on page 24, and therefore focusing upon taking the citizens and tourists' needs into consideration. The harbour front and the fjord are frequently used, and it is not abnormal to spot people starting the day with a swim in the Norwegian fjord and warm sauna before work. The harbour front is used both in winter and summer time therefore the lack of functions and urban developments is evident. Therefore, the municipality established temporary bathing areas which have been overflowed during summers by the citizens.

There is an old Norwegian saying that nature is the best form of medicine therefore it is extremely unfortunate that the city of Oslo lacks urban areas. Close to the central district there are the garden of the Royal Palace, Botanical garden and Ekebergparken sculpture park but the parks are 25-30 min away by foot from Sukkerbiten. The gardens are frequently used throughout the year but especially during summer by both citizens and tourists. But it is clear there are approximately 2 km to nearby parks from the project site (Visit Norway, n.d.).

Sub-conclusion

The lack of urban areas and swimming possibilities makes it clear that the project must focus upon the development of the harbour front at the project site. As mentioned previously in the report the project site contains both A10 and A11. These areas have different functions since A10 will relate more to the beach area that connects the Opera house and A11 while the urban area at A11 will be more influenced by the photography museum. But it is very important that both urban areas at the site are inviting to visitors and non-visitors of the museum. The overflow of people of the temporary urban areas at the harbour front clearly indicates the high interest of the citizens and tourists.



The Royal Palace garden
2.2 km (30 min)

Ill. 37



Botanical garden
1.9 km away (25 min)

Ill. 38



Ekebergparken sculpture park
2.1 km away (30 min)

Ill. 39

CLIMATE CHANGES

1.1 SITE ANALYSIS

The world is changing, and it has been since the industrialization, and with the continuous growth within the industrial sector, the world is changing faster than ever. Norway is no exception within this global climate threat and multiple aspects have been changing since the industrial era began. The UN's Climate Panel estimates that human activity has led to a global temperature increase of approximately 1 degree Celsius compared to the pre-industrial era. And within the last 10 years, Norway specifically has experienced (Miljøstatus for Norge, 2020):

- There has been a steady increase in temperature.
- The seasonal rain- and snow patterns have changed.
- Melted snow and ice has affected the acidity of the water and the access to water in multiple places.
- Permafrost has gained a slight tint.
- The ocean has become warmer, the sea level has risen, and the water has become more acidic.
- Periods of extreme weather conditions have been more frequent and more extreme when present, this tendency is visible from 1950.

According to the National Oceanic and Atmospheric Administration (NOAA). There are six possible scenarios of different increments in the sea level, and they have substantial variations. The six scenarios vary in their extremity but the UN and NOAA alike estimates that the most likely scenario would be an increase of approximately 1 meter, which would be the intermediate scenario (appendix 1), in the year of 2100, if little is done to alter this pathway (Lindsey, 2021). This is illustrated on the following through diagrams.

Sub-conclusion

The site located at Sukkerbiten, Oslo, is at risk of succumbing to the sea water increase, which means that the pier design must consider the future climatic conditions and their consequences within its usage and layout. It should in theory be designed to last 80 years or until dismantlement. Also, the building itself should be slightly raised on a platform to become planar with the new pier established on the northern section of the site, which is at elevation number 1.870 m above sea level.



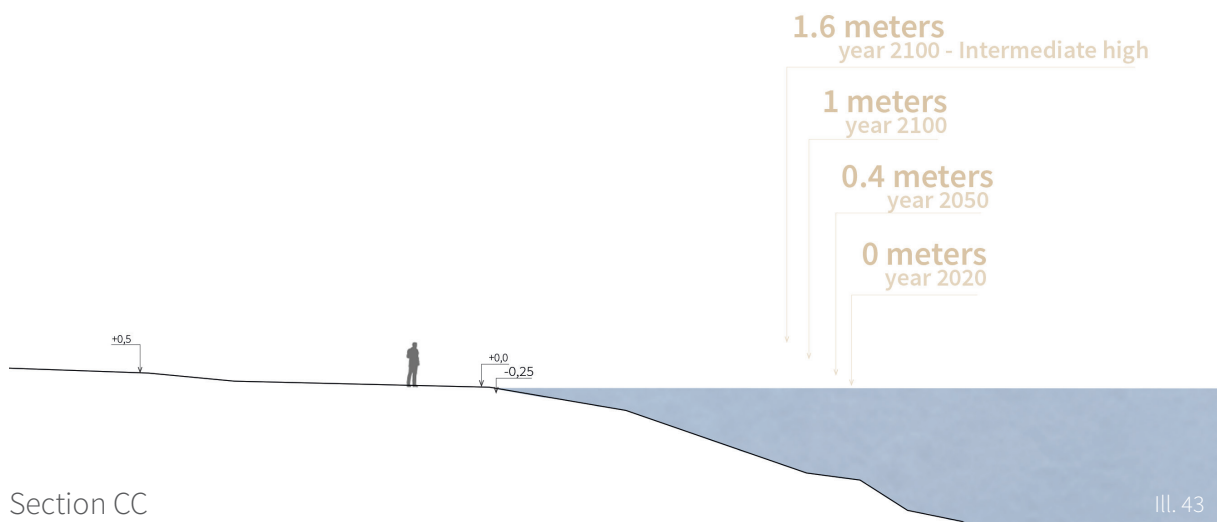
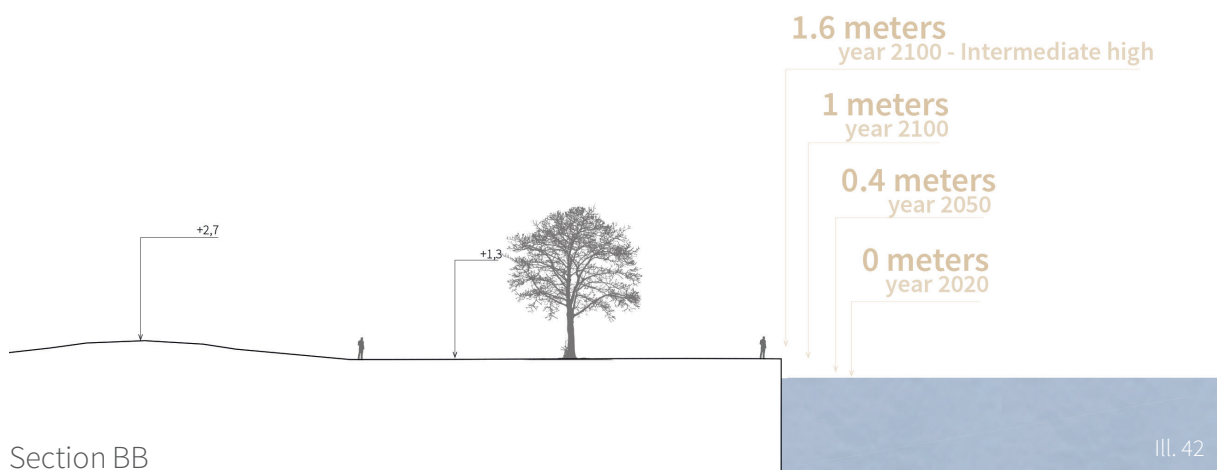
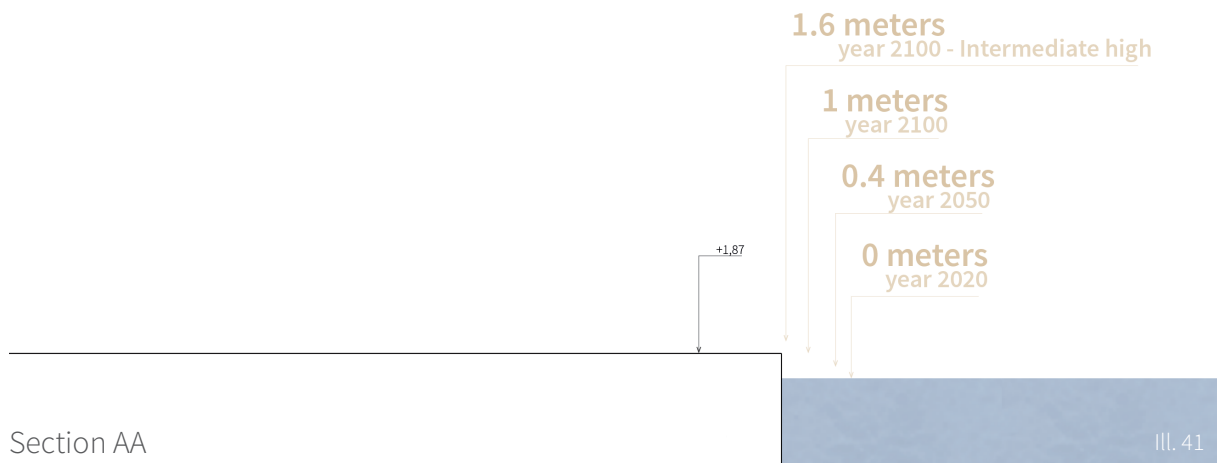

SOCIAL INTERACTION AND THE INFLUENCE ON HEALTH

1.2 THEORETICAL ANALYSIS

Various scientific studies show evidence that social relationship involvement has a positive influence on health. A strong evidence comes from prospective mortality studies performed across industrialized countries. The studies consistently indicate that individual people with the lowest involvement in social relationships are more likely to become stressed, depressed or even die, than individuals with high involvement in social relationships (Umberson, D. and Montez, J., 2010). Furthermore, Swedish studies indicate a relation between culturally active people and longer lifespans, thereby stating that people who actively participate in museum exhibitions and other cultural gatherings live longer than people who do not. A similar tendency is seen in increased social activity and higher levels of education (Umberson, D. and Montez, J., 2010; Bygren, Konlaan and Johansson, 1996). The studies performed by Umberson and Montez also suggest that there is a clear connection between health and social relationships, and that this connection can be explained through three subjects:

- Behavioral attitude
- Psychosocial conditions
- Physiological conditions

Behavioral

Health behavior is defined through the active decisions a human makes regarding nutrition, exercise and social relations. Social relations are affective by architecture and the physical environment, and the ties generated can beneficially affect the nutritional and exercising potential of an individual. And in a way, the social ties are the developing factors of social norms, which

then are the determinants of how society perceives positive or negative behavioral attitudes (Umberson, D. and Montez, J., 2010).

Studies suggest that architecture may affect the behavioral attitude of people in urban spaces (Mahmoud, 2018). It is important that urban areas are designed with personal space in mind, as to allow the individual person to drop their guard and perceive the settings. Mahmoud mentions that it is possible to force people to behave in a certain manner within a setting, but without creating the space for the individual, it will have no positive effect on the psychosocial condition of the individual. Also, material choices enable a person to identify the setting and make it relatable to existing perceptions, thereby cognitively directing an individual's behavior (Hellwig, 2020). For example, concrete might induce the existing perception of factories or abandoned buildings, which might cognitively direct the individual into a slight careless attitude, whereas marble or natural materials might direct the individual into a careful and respectful attitude (Mahmoud, 2018).

Psychosocial

Research suggests that there are possible psychosocial mechanisms which explain how social ties are beneficial to health. Some mechanisms are social support, personal control and mental health. And to identify how architecture can play a pivotal role in creating the physical environment for festering these mechanisms, it's important to understand the three mentioned. Social support is the reduction of the impact of stress through the utilization

of established emotional supportive relationships. Personal control is affected by social ties through the aspect of symbiotic increase in health behavioral habits. Mental health is an important mechanism which works in cohesion with the other mechanisms to create physical health. For example, the emotional support provided by the social relationships improves the psychological condition, which in turn, might be a crucial aspect to avoid unhealthy behavioral tendencies (Umberson, D. and Montez, J., 2010). The nourishment for a sane mental health arises in the social ties and informal as well as formal connections made with various people. Architecture with a focus on social interaction and creating the possibilities of informal greetings might be the birth of new social ties between the visitors of the exhibition. This could be done by creating the framework of activities within the exhibition center, which encourages social interaction between various genders, races, and ages. This would make the House of Photography a crucial sociocultural gathering point in Oslo.

Physiological

Social processes can influence the physiological processes which help explain the connection of social relationships and health, which has been researched thoroughly by sociologists, psychologists, and epidemiologists. An example could be that having social interactions with other people benefits the immune, endocrine and the cardiovascular functions of the body (Umberson, D. and Montez, J., 2010). It is furthermore shown that social support for adults' assists in managing anticipated and existing stressors more successfully.

Sub-conclusion

In conclusion, the relationship between social interaction and health related conditions is visible, and it affects a multitude of the psychological and physiological mechanisms of the body. Architecture, however, can create the frame of social interaction through programming and wayfinding, which allows for formal and informal experiences, and improves the sociocultural potential of the House of Photography.

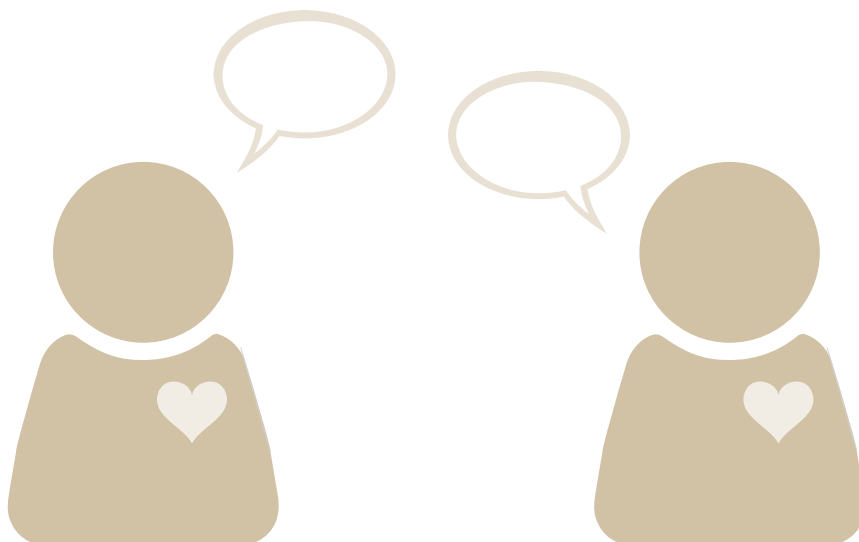

Ill. 44

THE EXHIBITION POTENTIAL

1.2 THEORETICAL ANALYSIS

The purpose of a given exhibition is to transform some of the aspects of the visitors' interests, values, or attitudes. This transformation happens in the moment a visitor discovers a certain meaning in the perceived art on display, and the meaning varies from person to person based on their motivations and individual beliefs (Ahmad, S, 2014). This perspective makes the visitors' interpretation of the perceived artworks central to the exhibition designs' success. Furthermore, is the difference in interpretation the central subject of conversation between visitors, which can encourage the establishment of new social ties. There might be as many various interpretations of art as there are visitors, but the overall exhibition thematic can be classified under three general sections (Ahmad, S, 2014).

Contemplation

The contemplation theme is mostly preferred by art museums, although not limited to these, and aims at an aesthetic experience. It is indulged by displaying individual works of art, images, or artefacts, which are intended to be appreciated as singular works of art, individually unaffected by surrounding exhibitions. The exhibition method tends to revolve around a particular theme, as to have an underlying connection between the various exhibitions. The contrast between various exhibitions can become a talking point and initiate discussions.

In this contemplation theme, the visitor remains relatively inactive physically, although the intellect and emotions may be fully engaged (Ahmad, S, 2014).

Comprehension

Unlike the theme of contemplation, comprehension revolves around creating cohesive narratives through the association between the various exhibitions rather than the individual. This is often seen at history and natural science museums, but not limited to these. A single exhibition can be divided into separate sections with varying narratives and themes. The purpose of comprehension is to encourage visitors to identify their own position based on relating the individual pieces to the contextual narrative. Here the visitor is more physically active than the contemplation in order to move back and forth through the items on display to understand the context (Ahmad, S, 2014).

Interaction

Uniquely to the interaction theme is, that it's based on communication with external means either through individual exploration or group based guided tours. It's a very individually involving method in which staff, volunteers, or exhibitions acts as hands-on education. Surveys represent, that people are having largely positive feedback to having an informed guide to communicate with. The person-to-person interaction has potential to become the most efficient educational method. Interaction based exploration covers aspects of workshops, lectures, presentations, and multimedia engagement, which has strong potential to reach a broad array of visitors. This particular method has been appreciated by children's museums and science centers, but within recent years also adopted in other fields (Ahmad, S, 2014).

Sub-conclusion

The architecture must support the construction of the three various exhibition strategies.

This translates into the requirement of room for contemplation, the possibility of constellating narratives through comprehension and allowing for interactive learning through room for lectures and workshops for young and elderly people alike. Furthermore, must the architecture create physical environments where discussion of the exhibition thematic are encouraged and possible. This supports the claims of the architecture being able of assisting in creating social ties.



Ill. 45



Ill. 46



Ill. 47

ATMOSPHERE

1.2 THEORETICAL ANALYSIS

Through “Experiencing Architecture” Steen Eiler Rasmussen covers multiple aspects of constructing atmosphere and narrative (Rasmussen, a, 1962). Rasmussen describes the primary role of the architect as the theatrical producer through following quote:

“The architect is a sort of theatrical producer, the man who plans the setting for our lives. Innumerable circumstances are dependent on the way he arranges this setting for us. When his intentions succeed, he is like the perfect host who provides every comfort for his guests so that living with him is a happy experience.” (Rasmussen, b, 1962, p 10)

Which strongly suggests that the architect is the construct of physical environments which foster the desired behavioral response by the visitors. The statement is as relevant for larger cultural constructions as it would be for a private home. Constructing the physical environment, becomes a task of forming a narrative. The narrative of an art exhibition might utilize aspects of contemplation and comprehension through the physical means of room size, material tactility, colors, sounds, smells, and lighting conditions. The activation and stimulation of the human senses, through the spatial layout and challenging the mind's perception to anticipate the following physical environment becomes fundamental aspects in establishing atmosphere. Exhibition design has certain requirements to create physical settings which puts focus on the exhibition. These requirements tend to mellow the tactility, color, and shapes of the physical elements in

order to reduce the visual noise produced by the static elements. Concise examples of this will be investigated through case studies later in the report. Atmosphere is the psychological manifestation of spatial composition and, the certain atmosphere of a physical environment strongly influences how the space is perceived by a visitor. In this case, the House of Photography could see increased amounts of re-visiting guests if the atmosphere of the place is convincing (Kulturministeriet, 2019). Light contains a multitude of spatial properties. The character of a room can vary drastically by the way the openings are shaped, sized, oriented, and placed. A window in the corner will induce a very different atmosphere as compared to a window placed in the middle of a room (Rasmussen, a, 1962). It is important to note that quantity and quality of light differs from one another.

“Two perpendicular planes are evenly illuminated from sources that can be controlled, the light can be so regulated that two sides will look equally light. When this happens the edge of the corner can no longer be observed by the eye, and even though the stereoscopic character of your eye can determine the corner, you will have lost an essential means of seeing that there is a corner.” (Rasmussen, c, 1962, p 189)

Through that quote it becomes evident that solely increasing both sources of light has no beneficial effect on the perception of the corner, but by reducing one factor, the shadow becomes the defining light that emphasizes the corner and increases the spatial legibility. Thereby also concluding, that good light doesn't mean the

intensity of light, but rather the variations of intensity which defines the rooms ambience, textures, corners, and spaces. Materials have a large influence on how certain physical environments are perceived. For instance, if one mentions that a room is cold and formal, it rarely indicates that the actual temperatures are low (Rasmussen, a, 1962). The statement grounds in one, or more, of three different indicators.

- Feeling - The sight of the forms and materials in the room might induce a certain connection to former experiences within the mind of the perceiver.
- Seeing - The colors might be blue tinted and identify as cold colors and thereby induce a certain atmosphere in the eyes of the perceiver.
- Hearing - The acoustics within the physical environment are hard and sharp with long reverberation time, and thereby create a certain atmosphere within the mind of the perceiver.



Sub-conclusion

As a conclusion to the chapter, and how to implement the theory into architectural design tools.

- The considerations on how spatial properties influence the physical environment and can structure a certain focus point for the visitor.
- The careful considerations of narrating the flow and experience through spatial layout
- The space perception developed through the utilization of natural and artificial lighting and how materials are perceived.

Becomes fundamentals in establishing directions and evaluating criteria when designing the art exhibition center the House of Photography.



URBAN SPACES AND HARBOUR RENEWAL

1.2 THEORETICAL ANALYSIS

Global urbanization challenges the possibility of creating green urban spaces, since the area is being converted into housing and transportation facilities, to supply the demand of urbanization (Haase D et al., 2017). To emphasize the relevance of urban developments within the urbanized cities, multifunctionality within the urban developments, to enable them to serve multiple purposes must be incorporated (Haase D et al., 2017). Urban developments become fundamental in actively dealing with negative aspects of climatic changes on micro scale, such as heat waves, air pollution and floods. Furthermore, integrating green urban developments in city strategies improves the quality of life by creating recreational spaces and enhancing human health through nature elements and social relations (Kabish et al., 2016; Umberson, D. and Montez, J., 2010). Another topic of urban development which remains relevant at Sukkerbiten, Oslo, is the renewal and transformation of the waterfront. It is noteworthy that the blue offered by the waterfront provides as many beneficial functions as the green nature does (Attia & Ibrahim, 2017).

With the convergence of an industrial waterfront into a social sustainable urban development the concern of overshadowing what was present at the harbour, both in terms of the physical environment and the local community's attachment to the area becomes pressing (Stern & Hall, 2018). Stern and Hall further investigates the notion of a "Post-industrial process of forgetting" where the industrial history will be overshadowed by a modern transformation, which can disconnect the city from its

industrial roots, and thereby challenging the genius loci (Stern & Hall, 2018).

Modern waterfront transformations and developments show a tendency to desire the attraction of the "Bilbao effect" which refers to the Guggenheim Museum in Bilbao and the effect the monumental building had on the municipal revenue and the city's reputation (Grodach, 2009). Furthermore, did the monumental building provide additional jobs and increase the social assemblance along the waterfront. The Bjørvika district contains monumental buildings such as the Opera house and the Munch museum already, which indicates that the urban areas developed at Sukkerbiten must contribute to the increased social assemblance along the renewed and transformed waterfront.

The sustainable model presented within the introduction of the report, contains a fundamental principle, social sustainability. The increased social assemblance indicates the improvement of social ties being formed. In order to create successful urban development which contributes to the city development as well as providing a safe environment, Jan Gehl and his 12 criteria of attractive urban places must be considered in a coherent structure with Stender and her 12 principles of social sustainability. Gehl's criteria concerns the actual urban development with basic aspects covered. Stenders criteria concerns the city development in cohesion with the urban development. Her criteria are divided into three categories: social cohesion, participation, and opportunity for everyone. Social cohesion ensures that developments within the

city remain true to the character of the place, that there is safety for the residents and users. There are various meeting places and social activities, the infrastructure for pedestrians is functional and that different user groups can meet. Participation ensures that the users have the opportunity to participate in the actions on free will and that the residents of a city are heard when

considering the city development strategies. Opportunity for everyone concerns itself with mixing of social backgrounds to avoid “ghettos” and to widen the public's horizon towards minorities, it ensures living offers in all price classes and requires occupational and educational offers in the city, and lastly it ensures a healthy micro scale climate (Stender, 2020).

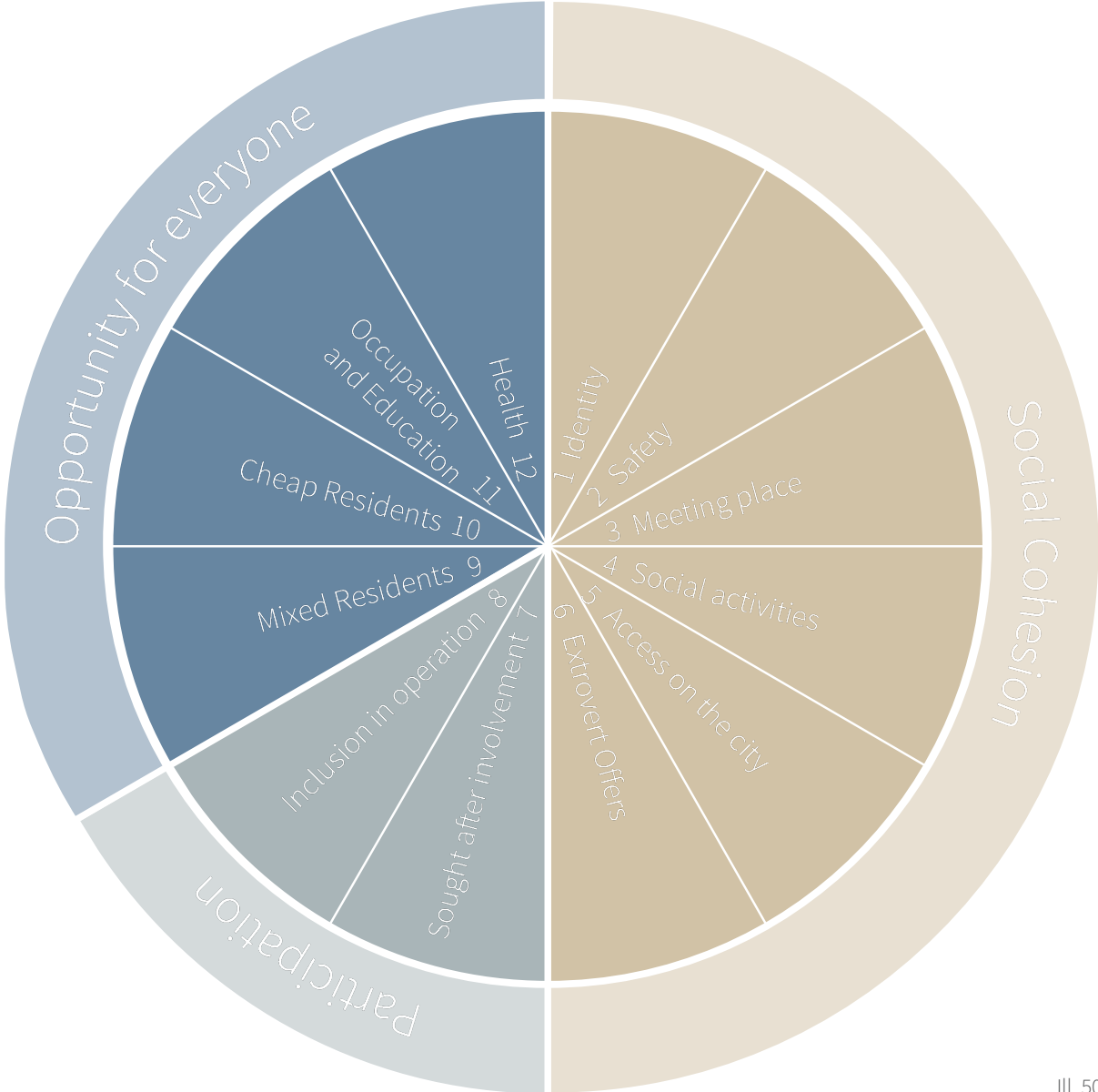

DESIGNING FOR DISASSEMBLY

1.3 ENGINEERING ANALYSIS

Considering designing for disassembly (DfD) in the development of a project, will have influence on economics, environmental impact, construction principles and the overall architectural expression, flexibility, and legibility. These aspects make DfD a strong base to construct architectural concepts upon. The practical possibilities of DfD also compliments multiple aspects of DGNB, but with its direct influence being on TEC 1.6, which expresses that a building must be easy to dismantle and repurpose the elements.

DfD relates itself to three major subjects of architecture:

- Environmental impact
- Construction principles
- Modular architecture

Environmental impact

Global scale material consumption is an issue, and up towards 30-40% of the total greenhouse gas emission and solid waste generation stems from the building sector (Hellwig, 2020). Much of this solid waste generation comes from the dismantlement of buildings, especially buildings constructed with concrete, bricks, and steel. The materials are being reused as much as possible, but it requires large amounts of energy to efficiently reuse, and there will still be solid waste left (Hellwig, 2020).

LCA is used to calculate the environmentally sustainable potential of a building through reference values in DGNB. To analyze singular subjects, such as envelopes, construction, etc. it is important to note, that envelopes must be comparable with envelopes. This means that possibly the u-value must be the equalizer, when com-

paring the potential sustainability of various solutions. LCA analyzes the material composition through production, transport, assembly, and end of life.

The different kinds of criteria in LCA are Greenhouse gases (GWP), Stratospheric ozone depletion (ODP), Tropospheric ozone formation (POCP), Acidification (AP), Eutrophication (EP), Abiotic non-fossil elements (ADPE) and Abiotic fossil elements (ADPF), where GWP weights 40% of the final result and the other factors weights 10%. This argues why the project considers GWP being the primary criteria to investigate.

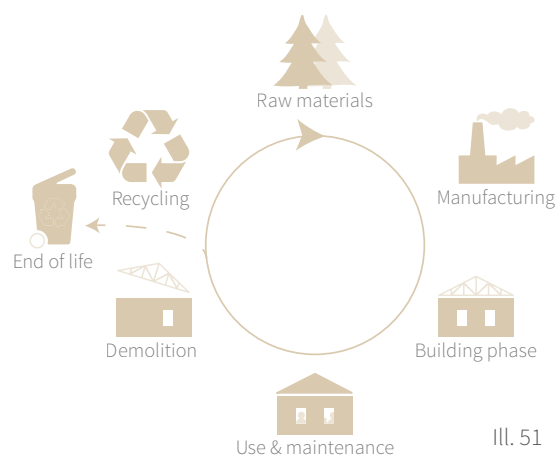

Ill. 51

Considering the environmental impact of various materials, special environmental product declarations (EPDs) are made by the producer of the various materials. Through these EPDs it's evident to determine the variation of environmental impact different materials have. For example, concrete and bricks are hard materials which require large amounts of energy and emission to produce (Betonelement-forenigen, 2020; Randers Tegl, 2020). Whereas, wooden elements accumulate carbon dioxide during its growth, and require low

amounts of energy to produce (Træ.dk a, 2020). Furthermore, the potential of reuse can be discussed, with concrete having the possibility of being smashed and used for gravel and asphalt, and wooden elements could either be taken as whole elements and moved into a new project, or be incinerated to generate energy or shredded into the production of wood cement elements as Troldekt. However, it is important to note that the lifespan of wooden elements would confidently be around 50 years, but concrete elements could be multiple centuries. This is the reason EPDs are based upon 50-year lifespan calculations, which allows them to be comparable.

Modular architecture

The combination of material choice and construction and joint principles can support the architectural style of modular architecture. Modular architecture allows for

flexible plan solutions with the load bearing elements and the technical installations, being structured in a grid, with the possibility of expanding and compressing the building size as necessary.

Sub-conclusion

A flexible plan solution is useful in this project of exhibition design, since it opens the possibility of rearranging exhibitions as the requirement of flow, sound and light might vary between the various thematic exhibitions. Thereby, the museum can place temporary walls within the construction grid defined by the modular architecture, and create the exact flow and narrative required to fulfill the exhibition. The material choices must reflect LCA considerations in aspects of environmental impact, joint structure, lifespan and maintenance. The construction joints must play a role in the architectural expression of the interior spaces which are illustrated below.

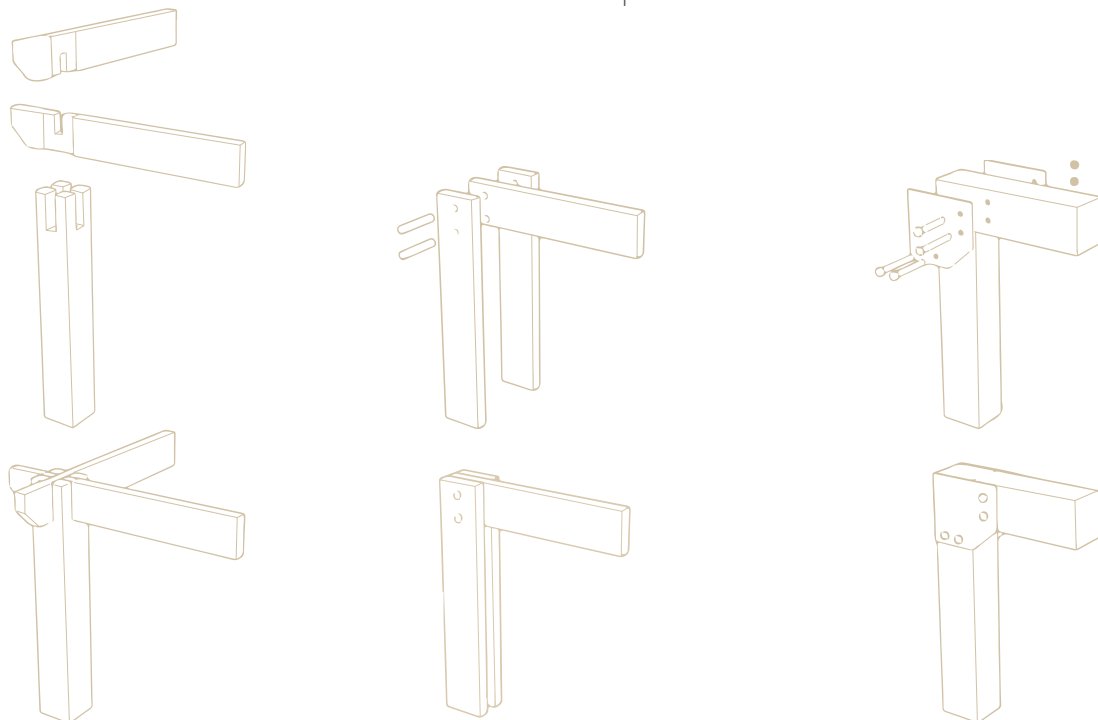

Ill. 52

TIMBER CONSTRUCTIONS

1.3 ENGINEERING ANALYSIS

Norway has a long-standing tradition of building housing units and public areas with wooden elements primarily. Before the industrialization and urbanization, many villages were built in the mountains and within the forests, and due to infrastructure and accessibility, it was the obvious choice to build the units from local wood. This cottage inheritance, of being a part of the landscape and showing respect to the surroundings is still visible in modern Norwegian architecture, with the parallels to their humble beginnings (Visitnorway, n.d.).

The traditional methods of building wooden housing units were designed from a focus of utilizing as much of the daylight as possible, since it is a precious resource in a country where the sun goes down at noon during winter, or does not even rise at some places (Visitnorway, n.d.).

During recent years, a knowledge of sustainable considerations and the environmental impact of certain materials and actions has become widely accessible. As stated previously in this report, the world faces global climatic issues, and to combat this, the UN created sustainable goals together with the world leaders and issued global climate goals. To assist in achieving this goal, DGNB, alongside other certification tools, were developed as guidelines for building owners. The architectural development on a global scale reflects the growing interest in building sustainable constructions. Since 2009, there has been a global race of having the tallest wooden construction (Jensen, 2017). A similar tendency was visible with the tallest skyscraper in the world, bringing with it many

innovative and evolving principles within steel and concrete constructions. Canada, Norway, England, and Holland have been exchanging the title of having the tallest wooden construction (Jensen, 2017). With its many environmental properties, one can wonder why more countries are not developing the same amount and scale of wooden constructions. Many established contractors are against building wooden structures in Denmark due to the concern of moisture and fire hazard, but Norway shows through multiple building projects, that it is not a concern (Olesen and Tinning, 2019).

What is a wooden construction made of?

Predominantly the modern approach to wooden construction is the implementation of cross laminated timber elements (CLT). CLT elements are wooden elements combined in multiple perpendicular layers and glued together. The result is a product of great stiffness and strength comparable to concrete elements. And this exact property makes it the suitable choice of material in many cases. Experts deem that there is no doubt that CLT will be the main rival to concrete, but first the bubble of concern must burst (Olesen and Tinning, 2019).

Building projects of CLT are to a high degree based on prefabricated elements, which allows for fast assembly on the building site, which was a similar case to when the concrete prefabrication method was introduced. A benefit CLT is that when the lifespan of the building ends, the dismantlement and reapplication of materials is equally as fast as when assembling



the materials in the first place (Olesen and Tinning, 2019).

As mentioned, a primary concern of wooden constructions is the fire hazard. However, CLT elements can be compared to non-flammable building materials, and has the significant advantage that it chars at a predictable speed, which makes it possible to predict how long the necessary building strength in a building can be maintained (Olesen and Tinning, 2019).

Aside from being the superior sustainable choice, wooden elements have a natural aesthetic to them. Wooden elements are living and varying in their appearance, they can develop cracks as they age, and some specific wooden materials develop certain patina which is considered of a high aesthetic value like cedar and larch (Ny Fillerup Savværk, 2021). Cedar in particular scores additional sustainable points in that it contains a natural resin which repels algae, moss, rot, and animals (Træ.dk b, 2016).



However, it is important to consider that wooden elements are not suitable for every application, and the notion of the modern hybrid building arose. Concrete has its clear advantage through its compression strength and its resistance to moisture and dirt. Wooden elements are not strong at being in direct contact with wet areas for longer periods of time. This is the reason CLT elements are not suitable for foundations, but concrete remains the best material (Olesen and Tinning, 2019).

ENERGY CONSUMPTION

1.3 ENGINEERING ANALYSIS

The energy production methods in Norway vary from the methods we know in Denmark. Norway has access to a large amount of waterfalls and can thereby utilize the method of hydro power. This means that a total of 99% of Norway's energy production is based on renewable sources (Statista, 2021). Denmark however, produces 40.7% of their total energy production on renewable sources (IEA b, 2020).

In Denmark there is a technical design paradigm of avoiding heating needs and lowering mechanical ventilation in order to supply these aspects with passive solutions and natural ventilation. However, this is partly due to the electricity being a pollution in Denmark, where 60% is produced by fossil sources. In Norway, where electricity is sustainable and non-polluting, there could be benefits in designing the building with more active solutions to avoid poor performance in the cold periods considering natural ventilation and insufficient heating, thereby improving the indoor comfort. Mentioned in the competition material is also, that the government pays $\frac{1}{3}$ of the operational cost of mechanisms.

Exhibition design and public buildings often require additional lighting consumption and will contain large amounts of glass in order to ensure transparency and daylight conditions. These aspects are having negative impacts on the overall energy frame of the building.

The following text is a presentation of passive strategies which can be implemented in the exhibition design.

U-value

The U-value of the elements in the building will be following the danish guidelines to ensure adequate insulating properties with a consideration of material usage (Rockwool A/S, 2020). Building with a sustainable mindset also requires the design to be considerate to the volume/surface area which relates itself to material usage, energy consumption, daylight conditions and natural ventilation principles.

Natural ventilation

Natural ventilation is an important aspect in both thermal and atmospheric comfort aspects as well as user experience. It is worthy to note, that natural ventilation is based on three different principles:

- Single sided ventilation
- Cross ventilation
- Stack ventilation

Where single sided ventilation and cross ventilation can have negative side effects of draft and gusts, which are unwelcome effects when working with photography exhibition due to the light weight of the material. Natural ventilation, however, is a valuable method in terms of overcoming over temperatures during summer. The third principle of stack ventilation utilizes thermal buoyancy as its driving factor and has small risk of providing draft or gust. Stack ventilation, however, requires a significant height of the room, but the specified room programme enables the buoyancy to become the driving factor due to the height requirement of the rooms.

Exposed thermal mass

Some problems with this type of public building with large amounts of glass is that during the night hours where there are no visitors, the building becomes very cold, and requires large amounts of energy to be reheated. Having exposed thermal mass at strategic points throughout the building could help in terms of storing large quantities of thermal energy during the day and releasing the thermal energy during the night, thereby reducing the amount of energy required to reheat the building during the day.

Passive solar gain

Strategically oriented windows in the southern facade will assist the heating supply unit during the winter period. Norway might have sustainable energy, but it will still cost money in order to operate. Assisting the heating supply with passive assets reduces the electrical requirement which can be economically beneficial. Furthermore, windows towards the south provide light and view which the heating supply cannot.

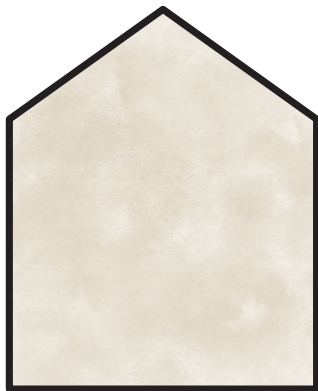

U-value

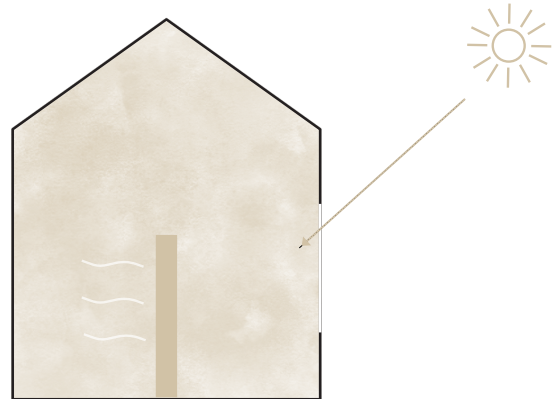

Exposed thermal mass

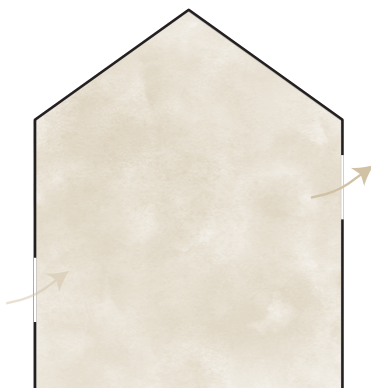

Natural ventilation

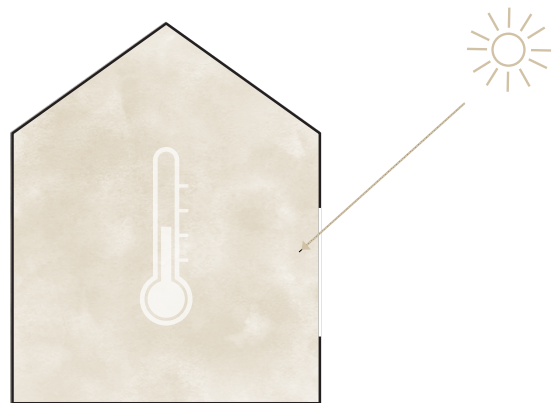

Passive solar gain

Ill. 55

INDOOR CLIMATE

1.3 ENGINEERING ANALYSIS

Indoor climate is dissected into four overall comfort areas such as atmospheric, thermal, visual, and acoustic comfort. Considering these four parameters while projecting is beneficial to spatial layout, concept development, constructive principles, energy conditions, and economics.

Atmospheric comfort

Having large gatherings of people results in excessive production of CO₂. This makes people drowsy and becomes toxic at high concentrations. To negate this, a hybrid ventilation principle of dimensioned mechanical ventilation and natural stack ventilation is utilized. The ventilation has effects on thermal conditions as it can agate cooling during summer and add heat during winter. The CO₂ level is required to not exceed outdoor concentration + 650 ppm (Dansk Standard, 2001).

Thermal comfort

Large buildings provide large volumes. The human body excels heat to the surroundings and can result in over temperatures in smaller rooms. However, large volumes require more energy to heat, and can often result in cool temperatures within the occupational zone. It is therefore necessary to investigate the operative temperature of various positions within the exhibition center to also validate the demands of DGNB and thermal comfort class II of having operative temperatures at 24,5 +/- 1,5 degrees (Dansk Standard, 2007).

Visual comfort

Good visual comfort is defined in the DGNB certification and includes daylight conditions on a minimum of 3% daylight factor and requires varying views to the surroundings. The vision of the House of Photography is to create large window areas to reflect transparency and good light conditions. Thereby the demand of achieving good visual comfort will be a driving factor throughout the design process.

Acoustic comfort

Exhibition design requires sound levels adapted to contemplation and adequate sound quality from the audio guides and interactive means. This requires that the reverberation sound of the exhibition areas do not exceed 0.6 seconds in any range of the hertz spectrum. Thereby setting requirements to the interior materials and possible the mantling of sound absorbing panels (Dansk Standard, 2003).

Sub-conclusion

In conclusion of previously explained considerations, this project will aim for the BR 2018 standard goals. This means that the building will be having an annual energy consumption of 41 kWh/m² or less including heating, ventilation, cooling, domestic hot water, and lighting of the building (Bygningsreglementet, 2021). Furthermore, must the building with its energy consumption uphold the standards of indoor comfort class II, in regards of atmospheric comfort, thermal comfort, and acoustic comfort. The building must utilize passive strategies in order of providing additional heating, cooling and energy saving conditions.



Atmospheric comfort



Visual comfort



Thermal comfort



Acoustiv comfort

III. 56

STUDY OF MATERIALS

1.3 ENGINEERING ANALYSIS

EPDs are great assets to analyze the environmental impact various materials have on the global emission. However, EPDs are based on various units, some in m^3 , some in tons, and some in m^2 . The units need to be comparable to make realistic analyses of the materials. In this study, rather than converting everything into m^3 or tons, a simple calculation of a beam carrying a predetermined load will dimension the amount of material necessary to fulfill the task at hand. This indicates a more com-

parable foundation to analyze the environmental impact.

This is done due to $1 m^3$ of steel can possibly be utilized to cover a larger span with its construction profiles than for example construction wood can. Therefore, it would not be fair to compare. Bricks, however, cannot be used as construction elements, but rather as envelope material. This material will therefore be analyzed in relation to envelope consumption.

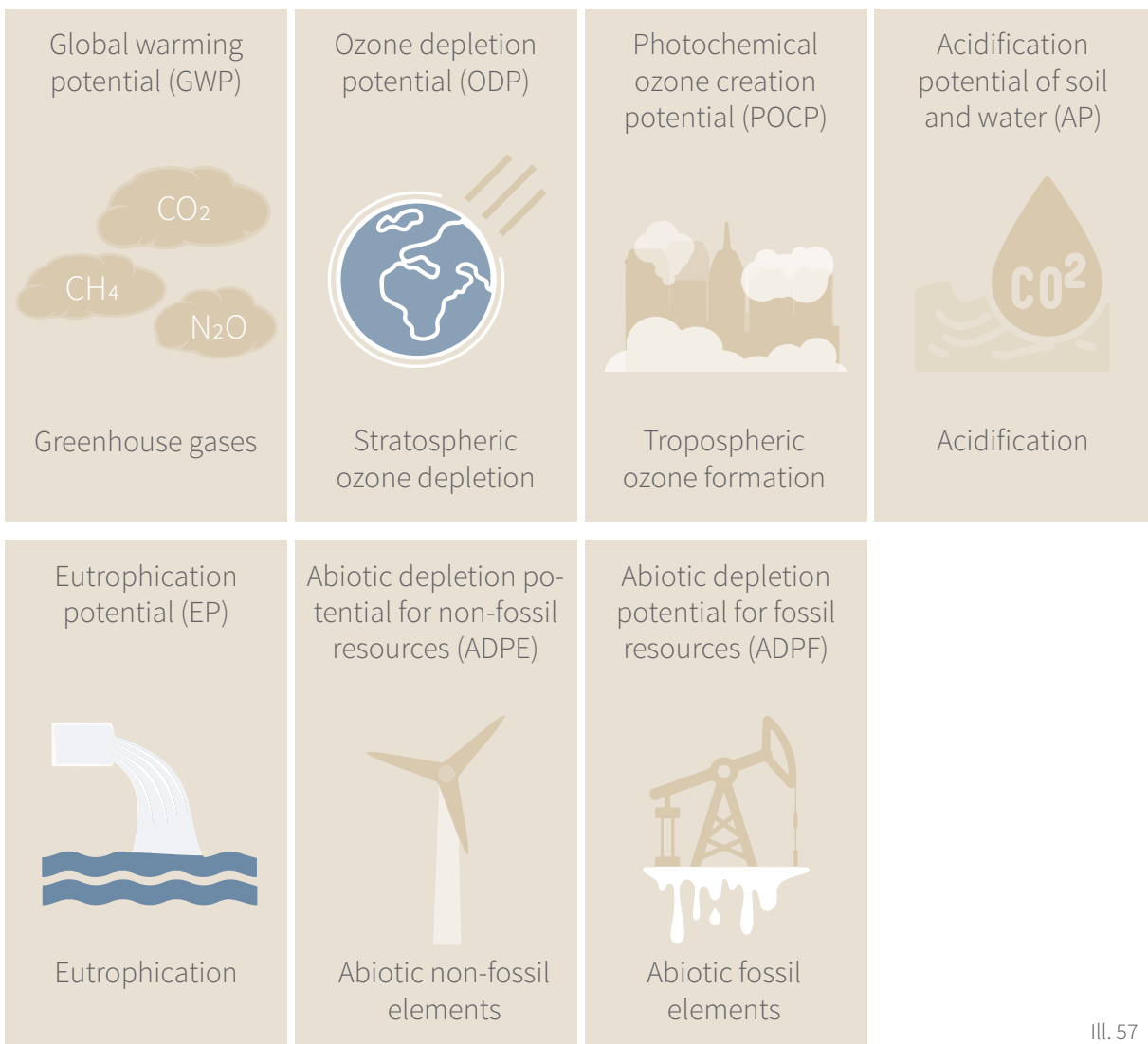

According to LCA scoring, GWP weighs 40% of the total score, with the remaining 6 factors weighing 15% each, it is therefore the most investigated and socially evident factor to consider. In this investigation, wood is the far superior choice of material, considering it is a material that stores carbon dioxide during its growth, whereas concrete and steel are material that only pollutes during their production.

Amount of material in relation (appendix 2):

Glulam wood: 0.48 * EPD in m³

Concrete: 0.3 * EPD in m³

Steel: 0.12 * EPD in ton

Sub-conclusion

The results and considerations point toward wood as the construction material being the most sustainable choice with the most apparent positive impact on climate change. The end-of-life phase of wood also supports a sustainable mindset more than the two combatting materials.

Indicator	Unit	Glulam wood	Concrete	Steel
GWP	Kg CO ₂ eq	-3.19·10 ²	6.45·10	1.26·10 ²
ODP	Kg CFC11-eq	2.04·10 ⁻⁶	0.8·10 ⁻⁶	1.01·10 ⁻¹²
POCP	Kg ethene-eq	1.57·10 ⁻¹	1.05·10 ⁻¹	3.6·10 ⁻¹
AP	Kg SO ₂ eq	1.06·10 ⁻¹	0.33·10 ⁻¹	0.2·10 ⁻³
EP	Kg PO ₄ ³⁻ eq	1.78·10 ²	2.75·10 ⁻³	3.1·10 ⁻¹
ADPE	Kg Sb-eq	3.41·10 ⁻⁵	1.03·10 ⁻⁷	0.175·10 ⁻⁴
ADPF	MJ	5.76·10 ²	3.4·10 ²	-

Ill. 58

STUDY OF ENVELOPES

1.3 ENGINEERING ANALYSIS

To initiate a study of envelopes, the fundamental comparative field must be laid. The danish manual “Den lille lune” is a guide to insulating properties, which advises that the minimum requirement of an envelope's U-value is 0.15, and the lowest u-value should be 0.09 (Rockwool A/S, 2020). This study will develop and discuss three variants of an envelope, concrete, bricks and wood, with a U-value of 0.15. The primary concern of this study is the sustainable profile through EPDs and LCA while also discussing their lifespans and the impact on the future of the building. The concrete envelope is the thickest envelope, and it has the lowest interior temperature and pollutes the most during production. Furthermore, the material is typically associated with an industrial feeling through its visual appearance and tactility. The brick-based envelope scores slightly better overall and the contextual value is befitting since the Bjørvika district and Sørenga area contains a large part of brick façade buildings. The best scoring solution is the wooden envelope since it is the thinnest, has the highest interior tem-

perature, and a negative value of GWP. This means that the envelope stores more carbon dioxide from the atmosphere than it pollutes during its production. The tactility and visual appearance of the warm and natural wood also separates itself from the surrounding context. The lifespan of these material varies greatly. The concrete and masonry units may last for centuries if not more, whereas the wooden cladding could last approximately 50 years in the conditions of the site, exposed to high amounts of salt and moisture. The façade cladding must be changed after a certain amount of years, allowing the old cladding to be incinerated or shredded to either provide energy and heat or material to produce other material. This is an expense that the two other envelopes do not have.

Visual impact

The variety of thickness impacts the way the wall is perceived. The thin wall proposal provides a lightness to the expression, which is very suitable with suspended elements, or in slim constructions. The thick wall seems heavy and reflects the

	Concrete envelope	Brick envelope	Wooden envelope
Thickness	446	441	400
U-value	0.15	0.15	0.15
Average heat loss	12 kwh/m ²	11 kwh/m ²	12 kwh/m ²
Interior calculative temperature	18.8	18.9	19.1
LCA - GWP	56 kg CO ₂ eq/m ²	37 kg CO ₂ eq/m ²	-121 kg CO ₂ eq/m ²

Ill. 59

Outside

1. Concrete (110 mm)
2. Mineral wool 032 (150 mm)
3. Concrete (110 mm)
4. Foil, PE (3 mm)
5. Mineral wool 032 (50 mm)
6. Claytec Lehm-bau platte
7. Claytec Lehm-Oberputz fein 06

Inside



III. 60

Outside

1. Bricks (108 mm)
2. Mineral wool 032 (150 mm)
3. Bricks (108 mm)
4. Foil, PE (2 mm)
5. Mineral wool 032 (50 mm)
6. Claytec Lehm-bau platte
7. Claytec Lehm-Oberputz fein 06

Inside



III. 61

base of a structure.

Functional impact

The thick wall subtracts an additional 0.22 m² floor area for each running meter of wall, this has a large impact on compact building plans, while also being “wasted area” in regular non-compact solutions. In the case of these two envelopes, both have thickness that supports that eventual window sills can act as seating area, however, the thin envelope is limited to this only being a possibility if the window is placed far to the exterior side of the opening.

Material consumption and operational pollution

This study aims to develop a position on the debate of material consumption versus the operational pollution. Translating this means that an envelope with a U-value of 0.15 is significantly slimmer than an envelope with a U-value of 0.08, and this thickness reduction provides more net area, while also reducing the overall material consumption. However, the thick wall

reduces the amount of resources required to maintain a good indoor climate, while also reducing the amount of resources required to heat the building. The study will develop one additional envelope, comparable to the 0.15 wooden envelope, and will reflect upon the difference in the fields of energy consumption, indoor climate stability, visual impact, and functional impact. The position will be chosen of whether to develop the project with 0.15 or 0.08 envelopes based upon the results of the study.

Sub-conclusion

It is determined to be the more sustainable solution to aim for wooden envelopes of 0.15 u-value, 0.12 u-value for roofs and 0.1 for terrain deck, which are the minimum requirements for BR18 (Rockwool A/S, 2020). The choice is based on the excess usage of material is not sustainable, when operational pollution is not a key factor due to the energy infrastructure in Norway being based on 99% renewable energy.

	Wooden envelope proposal 1	Wooden envelope proposal 2
Thickness	400	620
U-value	0.15	0.08
Average heat loss	12 kwh/m ²	6 kwh/m ²
Interior calculative temperature	19.1	19.5
LCA - GWP	-121 kg CO ₂ eq/m ²	-134 kg CO ₂ eq/m ²

Ill. 62

Outside

1. Wooden cladding(15 mm)
2. Spruce (25x200 mm²)
3. Ventilated cavity (25 mm)
4. Spruce (25x100 mm²)
5. Ventilated cavity (25 mm)
6. Cross laminated timber (60 mm)
7. STEICOflex 036 (140 mm)
8. Cross laminated timber (60 mm)
9. Foil, PE (2 mm)
10. Spruce (50x50 mm²)
11. STEICOflex 036 (50 mm)
12. Claytec Lehm-bau platte
13. Claytec Lehm-Oberputz fein 06

Inside



Ill. 63

Outside

1. Wooden cladding(15 mm)
2. Spruce (25x200 mm²)
3. Ventilated cavity (25 mm)
4. Spruce (25x100 mm²)
5. Ventilated cavity (25 mm)
6. Cross laminated timber (60 mm)
7. STEICOflex 036 (180 mm)
8. STEICOflex 036 (180 mm)
9. Cross laminated timber (60 mm)
10. Foil, PE (2 mm)
11. Spruce (50x50 mm²)
12. STEICOflex 036 (50 mm)
13. Claytec Lehm-bau platte
14. Claytec Lehm-Oberputz fein 06

Inside



Ill. 64

STUDY OF WOOD

1.3 ENGINEERING ANALYSIS

Introduction

The previous analyses determined wood as the most sustainable choice. The following analysis, therefore, has the purpose of determining the most suitable sort of wood to be used as facade cladding. Studies have shown that building with natural materials has health benefits while also improving the indoor climate. This is due to its moisture-absorbing qualities. The visual settings are influenced by materials and the natural materials are more pleasant for the eyes and the senses. To ensure the quality and sustainability of the material, FSC certified wood will be used. The certification ensures that the trees come from forests that provide environmental, social, and economic benefits therefore the focus points are maintaining and restoring the ecosystem by planting at least as many trees as used (Nordic Council of Ministers, 2019). It has been mentioned previously, that wood stores carbon dioxide during its growth. This is due to the photosynthesis happening within the leaves of the growing tree. It is therefore also evident that tree families with larger amounts of leaves store more carbon dioxide during their growth, which is why families such as oak store more than cedar and larch.

Cedar

Cedarwood is part of the large-red pine family, and it originates from Canada but there is also a Scandinavian branch of cedar that withstands the environment better. Cedarwood as facade cladding has become more common throughout the years especially because of the patina. Over time the surface patinates into a silver-gray color which makes the appearance neat for long-term usage. The wood does not require regular treatment due to the high amount of phenol which protects against rot and fungi, and the lifespan is estimated to 40-70 years (Træ.dk b, 2016).

Larch

Compared to other wooden types, Larch contains a higher amount of resin which contributes to long and high durability. A high amount of resin is placed close to the core therefore to secure the high durability, wood from the core must be put into use. For facade cladding in Denmark, the slow-growing Siberian Larch is used and the material has very close growth rings which makes the material eminent at resisting rot. The estimated lifespan of the material is 40-90 years (Danske Boligarkitekter, n.d.).



III. 65

Oak

Oak has high durability due to the high amount of tannin which creates a high resistance to rot and fungi. Oak's cell structure is similar to Spruce and therefore the material has the same disadvantages. The material is expensive therefore in Denmark it is mostly used for window frames or other detailing. The estimated lifespan of the material is 50-120 years (Danske Boligarkitekter, n.d.).

Pinewood

Pine is often used as a facade and construction wood since the material has high durability and good moisture repelling performance. The core of the wood is the most durable part but unlike cedar, pine needs more assistance to maintain the lifespan. The surface needs treatment to ensure to increase the protection against the environment. The estimated lifespan of the material is 40-85 years (Danske Boligarkitekter, n.d.).

Spruce

Spruce is excellent for façade cladding due to its robustness and performance of we-

ather resistance. The closed-cell structure maintains a healthy balance of moisture inside of the wood and resists external moisture and water such as rainwater. The wooden surface needs treatment but the cell structure makes it more difficult for the material to be impregnated therefore it is more vulnerable to fungi and insects. The estimated lifespan of the material is 40-70 years (Danske Boligarkitekter, n.d.).

Sub-conclusion

The GWP of the various types of wood contains transport of material but does not contain the environmental impact of various sorts of ointment and treatments the wood needs in order to repel the harsh environment. The wood with the lowest GWP is cedar due to its conifer needles and that the EPD contains transport from Canada to Germany. Cedar, however, is the only wooden material listed, that can repel the harsh environment at the site, while maintaining a long lifespan, without the addition of external treatments. The conclusion is, therefore, to utilize cedar wood as the facade cladding.



IDENTIFYING THE USER AND THE NON-USER

1.4 USER ANALYSIS

The primary literature of this analysis is a decade-long investigation of the danish museum visitors' experiences and classifications (Kulturministeriet, 2019). The Norwegian conditions are expected to align with danish conditions, and the premise of identifying the user and non-user remains the same. It is important to identify the reason why the exhibition centers are visited, and why they are not. This goes to encourage the architecture of the House of Photography to increase the social interest in cultural exhibitions.

The most represented user is a well-educated lady in her 60s who is very interested in art exhibitions and history exhibitions. She always visits the exhibition centers with her social group, and they discuss the exhibitions while perceiving the artworks and after they leave the exhibition area on a café. She visits exhibitions in order to advance her knowledge of various subjects and because she enjoys the contemplative experience that activates her emotions and various brain departments

The international user is a well-educated woman in her 30s who is very interested in cultural heritage represented through art and history exhibitions. Often comes alone and prioritizes visits where the possibility of audio guides in English and visual cues are present to assist her in navigating and gaining a further understanding of the exhibition's comprehension thematic.

She visits the exhibitions in order of expanding her cultural knowledge of various societies and enjoys relating to her own heritage. She seeks communication with the

locals in order to get perspective on the exhibitions.

The student is a young female in her 20s. She shows interest in the particular subjects of an assignment or education, and rarely visits the exhibitions without an educational perspective. She visits in a group with peers of the same interest. They tend to enjoy interactive based exhibitions which often includes a well-educated employee capable of answering questions.

Museologist John Falk researched why users attend museums and exhibition centers in general, what they do at the centers and what they gain from the experiences. Based on that research, Falk developed a theory of the users' motivations and learning patterns. This theory represents the six motivation factors (Kulturministeriet, 2019).

The knowledge seeking visits based on a general interest of the exhibition theme at the center. The knowledge seeking is curious, interested and visits the exhibition centers to attain more knowledge. 60% of the users identify as knowledge seeking.

The host is motivated by a social educational process and visits the museum in order to create good experiences for the host's entourage. The most important aspect for the host is that the entourage finds the exhibitions exhilarating. 34% of the users identify as being a host.

The experience chaser is primarily motivated by the idea of being at a culturally

important place. The experience chaser visits the exhibition centers to experience them and their atmosphere and concentrates on the most apparent and obvious works of art. 32% of the users identify as being experience chasers.

The charger attends the exhibition centers to regain energy and find time to contemplate and peace. The charger seeks

aesthetic experiences through the exhibition, the architecture, and the surroundings. 27% of the users identify as chargers.

The academically interested visit the exhibitions centers due to a specific academic interest. The academically interested remains critical and reflective to the exhibitions and the academic communication of the exhibition center. 26% of the users

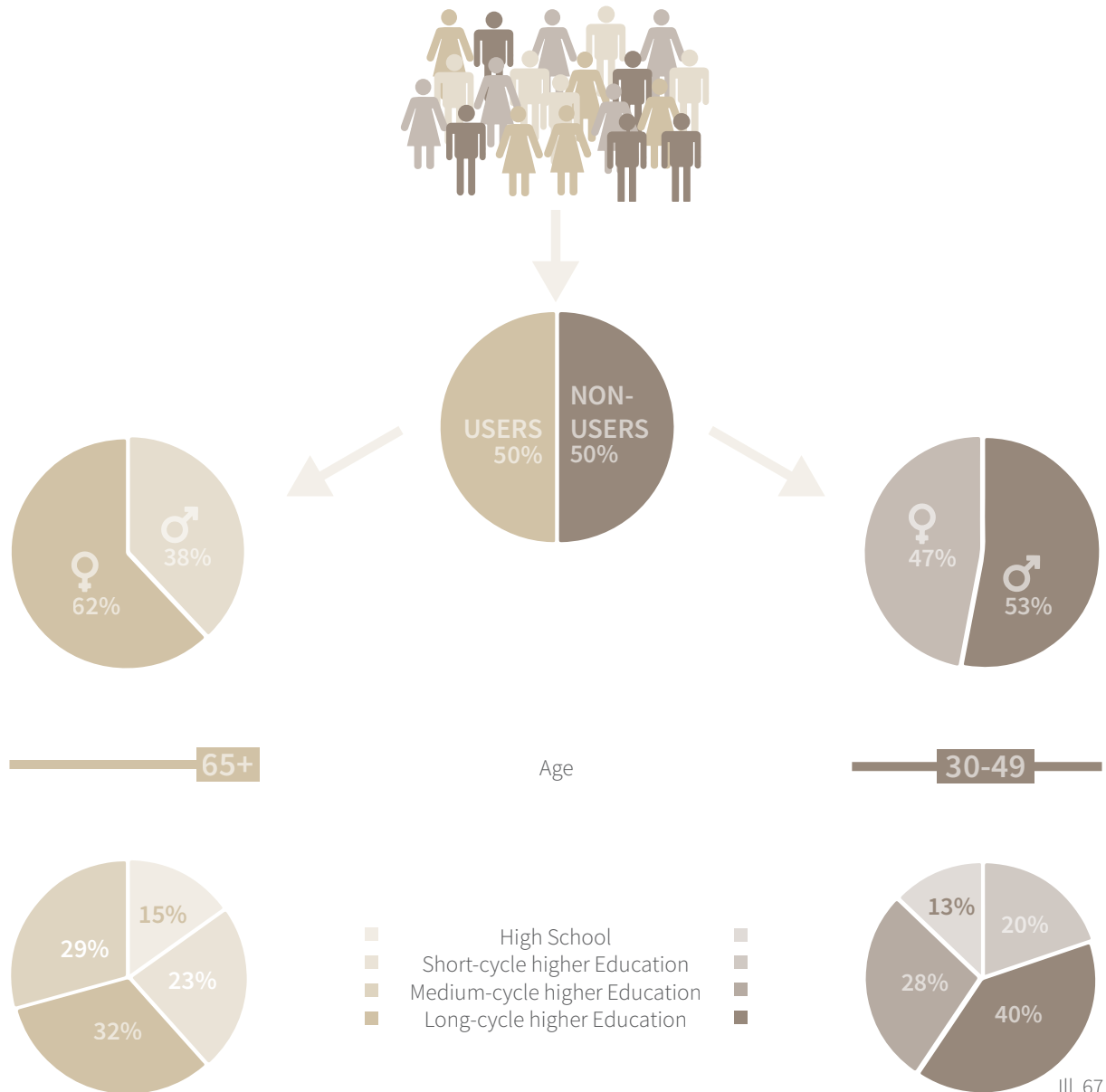

Ill. 67

identify as being academically interested.

The add-on is primarily on the exhibition centers because they accompany someone willing to visit the exhibitions. The add-on has no particular interest in the exhibitions or the center as a general. 15% of the users identify as being add-ons.

Common for the six categories is, that more than 60% within the categories are represented by well-educated women.

The non-user is identified as a person who has not visited an exhibition center within the 12 months prior to the statistics. The predominant non-user is a man in the range of 30-49 years old (Kulturministeriet, 2019). Amongst the non-users there is a wide consensus that museums and other public accessible cultural experiences are important for the danish society. However, the museums seem to be less relevant for the individual non-user. Which indicates that the thematic of museums and exhibition centers are irrelevant for the majority. It is mentioned that the primary barriers of the non-users are that they prioritize other activities, it is too expensive, and they don't have the social entourage to investigate the exhibitions with. For the short educated non-users' additional barriers occur in the form of not having any experience with exhibitions and the poor knowledge of various offers available.

68% of the analyzed non-users indicate that their previous experiences with exhibition centers was educational and 48% indicate that it was actually exciting. These factors support the previously mentio-

ned barriers as being the primary reasons and indicate that the actual content of the exhibition centers is somewhat relevant (Kulturministeriet, 2019).

To encourage the non-users for more frequent visits, the museums must make the exhibitions relatable for the majority of society, which supports the claims of multimedia presentation through screens, interactive methods, or audio guides (Kulturministeriet, 2019).

Sub-conclusion

Perspectivating the various theoretical exhibition potentials to a certain user persona proves difficult since the potentials support multiple claims on a single user. This further supports that the architecture must provide possibility of contemplation, comprehension and interactive exhibition, and the spatial layout should support the flexible placement of interactive information boards. The architecture must further support the option of relaxation, since a large portion of the visitors identify as chargers, the possibility of tranquility should be present.

However, converting a section of the non-users into users proved more difficult than anticipated, since the primary barriers are sociocultural subjects rather than topics directly affected by architecture and legibility. A barrier of non-existing entourage could be met and challenged by architecture through urban development, functional planning and a variety of activities, to support the construct of social ties which might generate the entourage for the non-users, converting them into semi-users.

THE STAFF

1.4 USER ANALYSIS

The House of Photography requires an administrative department with office spaces however, there are no project specific requirements for their particular needs. Therefore, the user analysis will be structured in order of defining the requirements from the Danish working environment authority, who has regulations that ensure good working conditions.

The house of Photography requires 5 individual offices, 1 of which is designated the

leader and must be larger. Furthermore, they require 2 large room offices, one for 4 people and one for 8 people. Finally they require a meeting room for 20 people.

The Danish Working Environment authority divides their requirements into four categories such as noise, temperatures and draft, air quality and interior design. The regulations are presented in the diagram below (At.dk a, b, c, d, 2021).

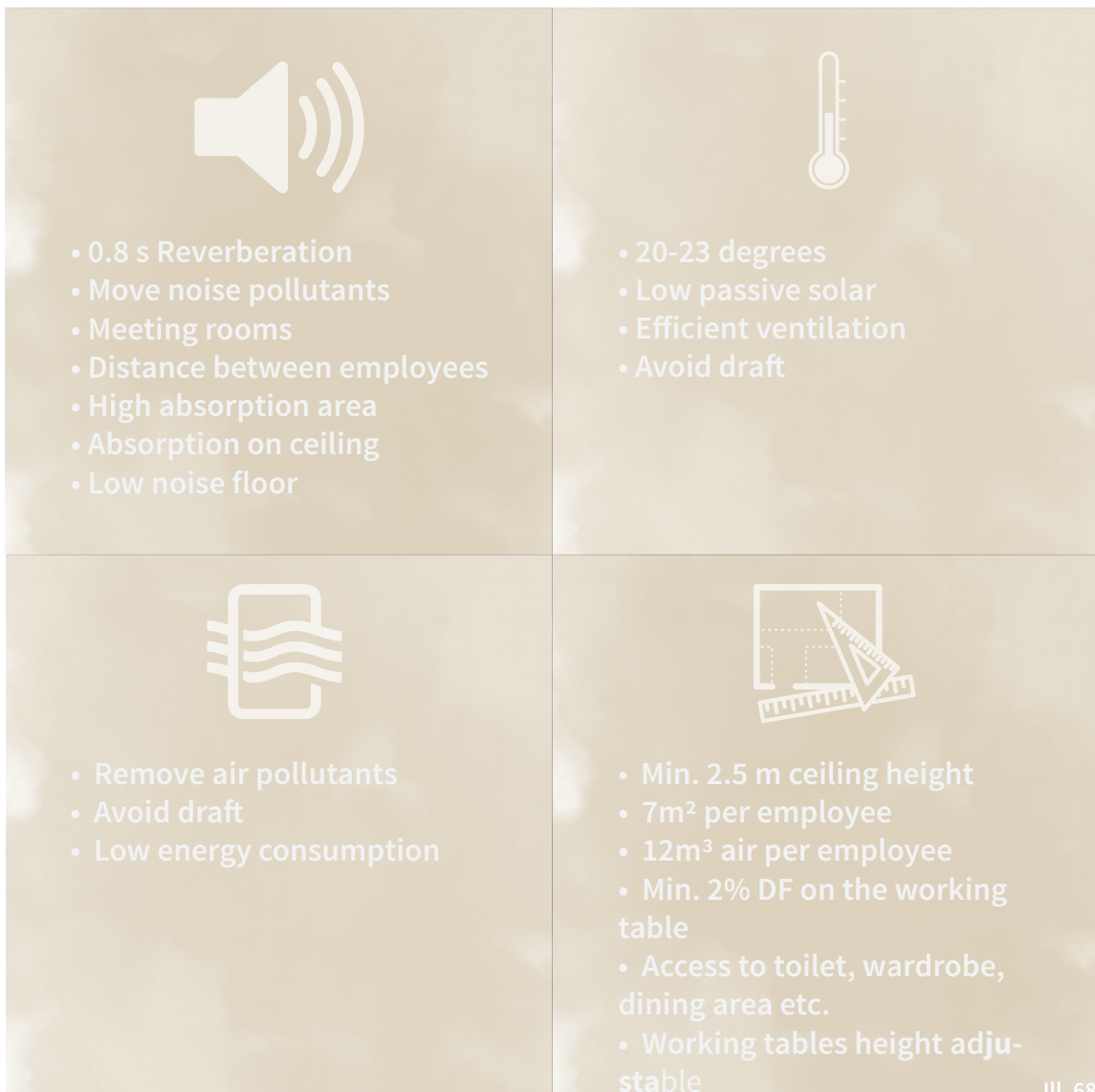

III. 68

INTERVIEW WITH PIXLART

1.4 USER ANALYSIS

To understand the photographers and their needs for the physical environment of exhibitions, a qualitative analysis has been done in the form of an interview with Tao Lytzen from PixlArt. PixlArt is a non-profit organization that has an exhibition area in a former church in Østervrå, Northern Jutland. The organization uses a digital exhibition strategy instead of the traditional analogue. Even though the museum is only a few years old, Tao Lytzen states, the museum annually has a high amount of visitors. The high amount of visitors may be due to the experimental approach of exhibitions. As mentioned previously they use digital strategies but the settings for the exhibitions are also quite unusual. PixlArt challenges the norm of exhibitions by using the context and other urban spaces to exhibit. Some exhibitions are mobile to reach a wide audience therefore, a bus is used to tour around in Denmark and especially in Northern Jutland (Højsgaard, 2019).

To ensure people have an interest in visiting the museum, they take its starting point in their own curiosity. They ensure there is a natural variation of exhibition material and it is important to be adaptable and be prepared to manage that the society and situation may change any minute. Therefore, the digital media is an important tool for PixlArt so they can easily change the exhibition material and strategies in different situations. PixlArt's digital exhibitions make it possible to reduce storage area and minimize logistic planning. To ensure they stay relevant, it is important to create a connection to the surroundings and the locals.

The physical environment has an impact on the experience, but it is important that the architecture and the environment does not minimize the quality of the experience. Therefore, it is important to have natural settings for the exhibitions. The exhibition method also gives different experiences for instance a real-life size photograph feels more intense and evokes more emotions. The size of the photograph makes it more realistic therefore it is easier for the individual to imagine the situation.

Throughout the museum the photograph must be the main character. The settings of a museum must be flexible to ensure the atmosphere can adapt to the different exhibitions. The atmosphere can change by the effects of light and noise to evoke all the senses.

Working with social interaction as a primary element in the museum requires the right settings. When a group comes to the exhibition they mostly observe individually and in silence. Therefore, the breaks between exhibitions are quite important. Interaction areas, restaurants, and workshops give the opportunity to create social interaction and let people reflect upon the photographs. The workshops are also very important to educate the non-professional user how to take a photograph and how to use it, as well as the consequences of the photography if they are used in a wrong way and what the impact may be (Lytzen, 2021).



Ill. 69 Credit: PixlArt



Ill. 70 Credit: PixlArt



Ill. 71 Credit: PixlArt



Ill. 72 Credit: RealDania



Ill. 73 Credit: PixlArt



Ill. 74 Credit: PixlArt

HOUSES OF PHOTOGRAPHIES

1.5 INSPIRATIONAL ANALYSIS

The House of Photography in Oslo refers to various other international arenas through their visions. The arenas include C/O in Berlin, Foam in Amsterdam, Fotografiska in Stockholm, and Jeu de Paume in Paris. These exhibition centers pride themselves on purveying photographs in artistic settings with strong socio-cultural themes. This case study will investigate how they deal with the exhibition design, and the requirement of flexible plan solutions in terms of various narratives in different exhibitions.

All four studios present their photographs with a predominant front light to ensure legibility and that every detail portrayed within the picture is visible to the beholder. This is done artificially to ensure equal conditions regardless of the outdoor weather. The studios are all located in old buildings, having their purpose transformed into an exhibition area. Another common aspect of their exhibition strategies is their utilization of artificial light instead of natural light. The natural light varies depending on the day and the season and might induce the risk of glare occurring in the photography frame, thereby possibly removing detail from the picture, and reducing the quality of the exhibition in the eyes of the visitor. Artificial light can be controlled to avoid negative influence and ensure high detail level of the display. Kirchner museum in Davos utilizes a suspended plastic paned ceiling, which turns the natural daylight into a diffuse light for the interior exhibition room. This building will be further investigated through a specific case study.

The exhibition material is presented on gypsum walls painted in neutral colors, which emphasizes the focus on the photograph. The narrative design in the two studios of C/O and Fotografiska are strikingly different. The C/O designs the exhibition in a hallway structure, which induces the feeling of comprehension through experiencing, perhaps a chronological story as seen in Hiroshima Peace Museum. Fotografiska utilizes the broad room with multiple photographs where the order of perception might not be important, but rather the comprehension of connecting the images afterwards.

All four studios are deemed worthy of note. Through extensive customer feedback it is considered that the museums are successful in their communicative abilities, and thereby some design considerations that can arise from this investigation.

- The exhibition material should be presented on neutral walls, which can be moved according to the various exhibitions.
- The narrative of comprehension exhibitions can be presented in various physical environments, and the architecture of House of Photography should support multiple experiences.
- The detail of the photograph must not be lost, and the high demand for adequate lighting must be met with artificial lighting for consistency.



CASE STUDIES

1.5 INSPIRATIONAL ANALYSIS

Moesgaard Museum
Year: 2014
Architect: Henning Larsen
Location: Aarhus, Denmark
Size: 16,000 m²

Moesgaard Museum focuses on establishing a cultural landmark and destination, which houses a wide array of user groups. The building implements nature, culture, and history, and thus defines a framework of archaeological and ethnographic exhibitions. The buildings form springs from the existing landscape as if the building arose itself from the fields, and the green roof is activated as an urban space for walk and talk. The building facades emanate transparency and the large internal stair attains a duality through its transit and occupati-

onal qualities (Moesgaard Museum, n.d.). The qualities of the project are reflected in the harmonious relation between nature, culture, and history while staying true and respectful to the close context. The activation of the roof has led to it being a destination for walks, and to some extent has attained a dominating secondary purpose. In its current state, the museum combats the roof in terms of primary function, since a large portion of visitors come for the stay on the roof, rather than visiting the exhibitions inside.



Ill. 83 Credit: Henning Larsen / Hufton + Crow



© 2014 Henning Larsen / Hufton + Crow

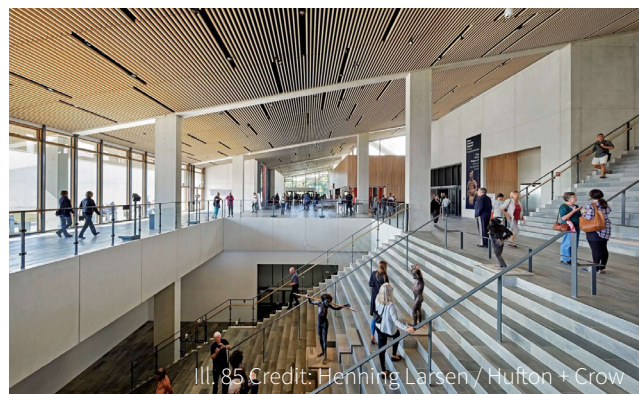

Ill. 85 Credit: Henning Larsen / Hufton + Crow

Oslo Opera House

Year: 2008

Architect: Snøhetta

Location: Oslo, Norway

Size: 38,500 m²

The project creates a cultural landmark for Oslo and creates public spaces for the residents and visitors at the area. The building shape is formed to create the possibility to use the low area towards the water for the public, which also follows Oslo new fjord city's interest. The building is created with large glass facades to open to the building and make it feel more welcoming for visitors. The purpose of creating this Opera house is to reach out to a wide audience and not only the usual audience (Norwegian National Opera and Ballet, n.d.).

The qualities of the project are the connection between the fjord and the building and how it creates public spaces and contributes to the new fjord city. The building form creates different kinds of public spaces and allows people to use the area for other occasions than only for opera shows. Therefore, the building and the public spaces creates settings for social interaction between different kinds of user groups.



Ill. 86



Ill. 87 Credit: Snøhetta



Ill. 88 Credit: Snøhetta

Haandvaerkskollegiet
Year: 2022
Architect: CUBO
Location: Horsens, Denmark
Size: 6,000 m²

CUBO is recreating old freight train areas into new colleges. The project is creating a characterful building with its material and construction choices giving it rustic strength while focusing on creating the home-like feeling. The building is about showing how classic materials such as brick in combination with modern architecture can create a functional and unique building. The grid-based construction gives the building the possibility for flexible plan solutions and gives the building robustness. The combination of wood and bricks strengthen the visual of the con-

struction and creates an open architectural environment (Cubo, n.d.).

The qualities of the project are how the combination of the classic materials and modern architecture in form of the construction can create an attractive home-like feeling building, with focus on showing the construction and openness. The visible construction clearly becomes a central part of the entire architectural expression while allowing flexible plan design.



Ill. 89 Credit: Cubo, Danø Arkitektur og BRFFonden



Ill. 90 Credit: Cubo, Danø Arkitektur og BRFFonden

Den blå kant

Year: On going

Architect: Årstiderne Arkitekter/Sweco Architects

Location: Svendborg, Denmark

Size: 80,000 m²

The project is focusing on recreating an industrial area into a new attractive area for the public with focus on climate assurance for storm surge and cloudburst safety. The focus of the project has been on climate assurance and maintaining the existing cultural environment and adding new recreational and social values to the city. Årstiderne Arkitekter has climate secured the area with a combination of various technical aspects which does not have any visual impact, such as cancel locks which will be active when needed. Årstiderne Arkitekter has secured this area and crea-

ted an attractive area by adding a harbour bath and the possibility for stay without creating any visual barriers to the water from the city (Årstiderne Arkitekter, n.d.).

The qualities of the project are how the transformation of the harbour with focus on climate assurance has been designed without creating any visual barriers and providing the public with the possibility of using an old industrial area for new activities, such as a harbour bath, playground and occupational zones.



Ill. 91 Credit: Årstiderne Arkitekter/Sweco Architects



Ill. 92 Credit: Årstiderne Arkitekter/Sweco Architects

ANALYSES SUB-CONCLUSION

Through the various analysis conclusions, it becomes possible to produce design parameters, which aims to indicate a direction of designing. The function- and material mapping analyses, presents a possibility of creating a new cultural destination in this area full of existing cultural landmarks. The analyses also indicate that a broad spectrum of materials can be utilized as there is no clear guiding direction, and the materials used assists in establishing an individuality. The area of the cultural cluster is very dense, with the primary traffic being pedestrians and bikers. This incites the creation of urban spaces with focus on being accessible for pedestrians and bikers, while also establishing transparency in the building to create a close relation between interior and exterior spaces. The case studies of Haandvaerkskollegiet and Oslo Opera house present design directions of how to establish transparency and how to establish flexible plan solutions.

Analysis of the climatic conditions at Sukkerbiten and of the global scale indicates that some sort of coastal protection must be established, this could be done through urban development which emphasizes social interaction. The case study of Den blå kant investigates how to develop this kind of coastal protection without being a visual noise polluting asset. The same climatic threat induces the requirement of considering DfD into the core concept, as this assists in developing flexible plan solutions, but also ensures a future where dismantlement and relocation is possible. Various exhibition strategies further emphasize the requirement of flexible plans to fully tailor the narrative of a certain exhibition theme. Flexible plans also allow for altered purpose at a later stage in case the building changes owner and purpose, which also supports sustainable potential according to DGNB.

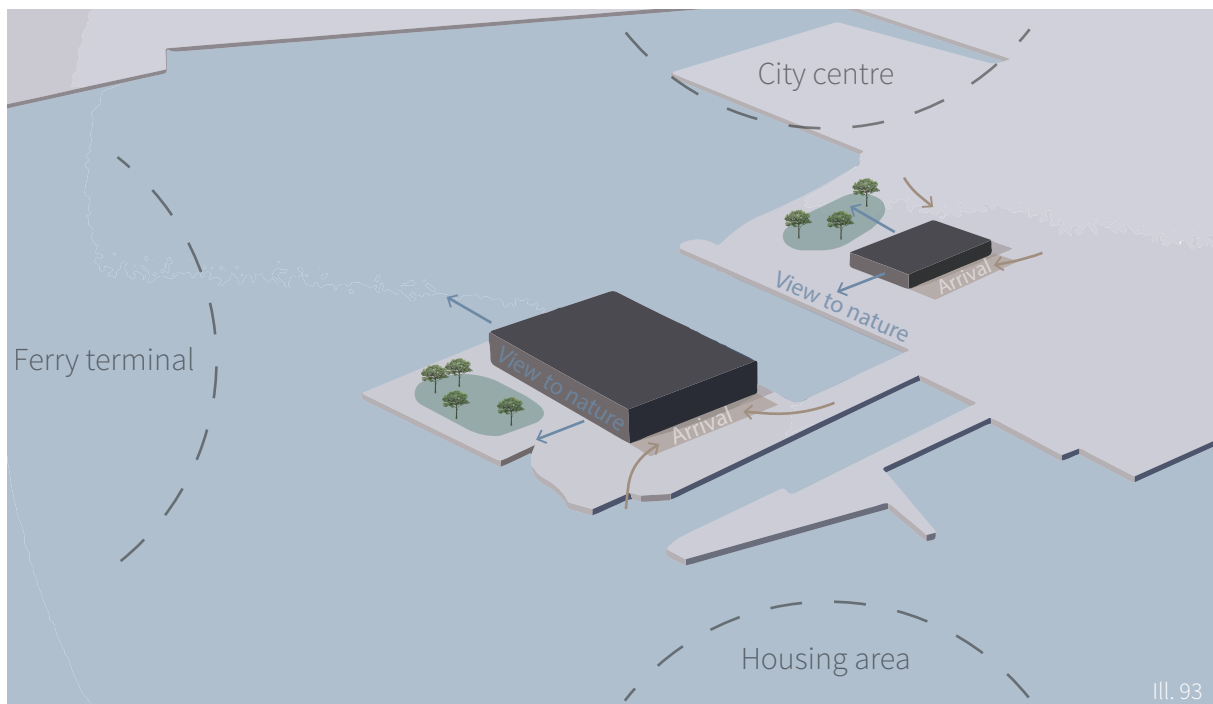

By investigating the users and the non-users, it becomes apparent that the building should suit the users' needs and foster a positive experience, while also attempting to invite the non-users for a stay. This stay can be within the urban environment, or the social offers surrounding the build-

ding. The architecture and programming attempts to challenge the perception of elitism within museum perception, thereby promoting social sustainable activities through the means of Stender's 12 criteria. The wider audience of the cultural destination also indicates an improved life quality and expanded life span among them.

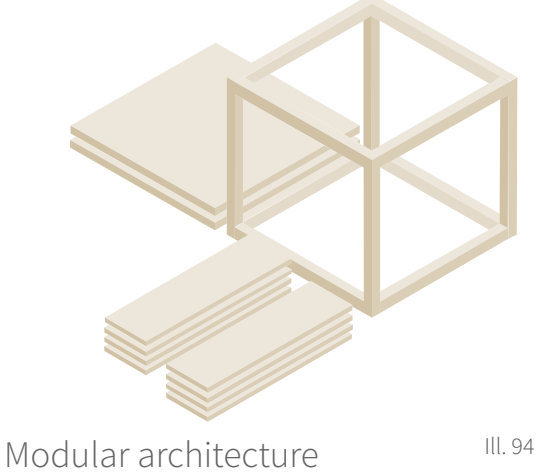
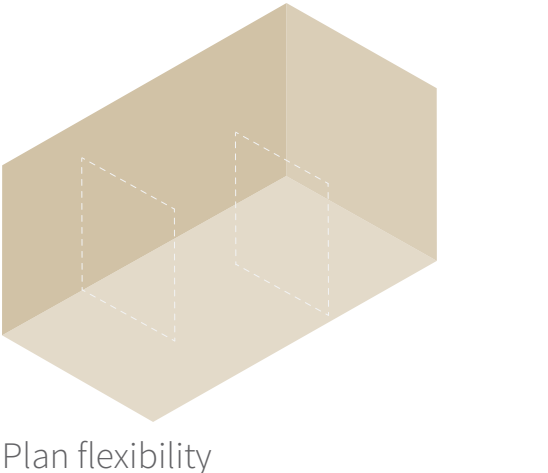
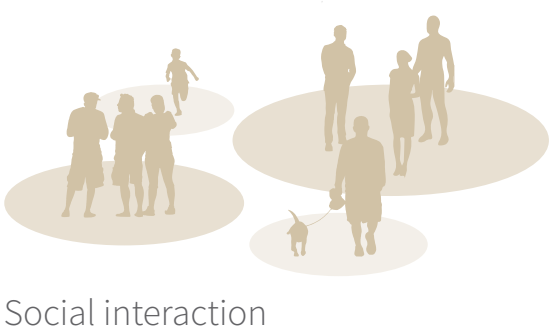
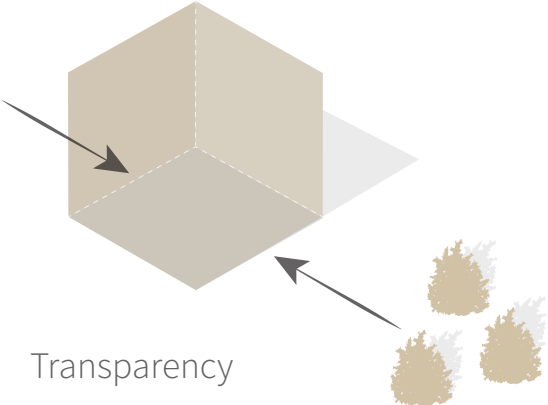

Ill. 94

02 DESIGN STRATEGIES

FUNCTION DIAGRAM

The following function diagram and room programme are initial diagrams which have been taken directly from the published competition material. Due to considerations and reflection upon the quality of the established diagrams thereby investigating the connection and placements of the functions. The function diagram and room programmes create a flow that ensures the quality of the visitor's experience and at first considerations do not create further problems. The function diagram and room programme will not be changed or further developed and detailed, but instead followed because of these qualities unless new knowledge is unveiled during the design process.

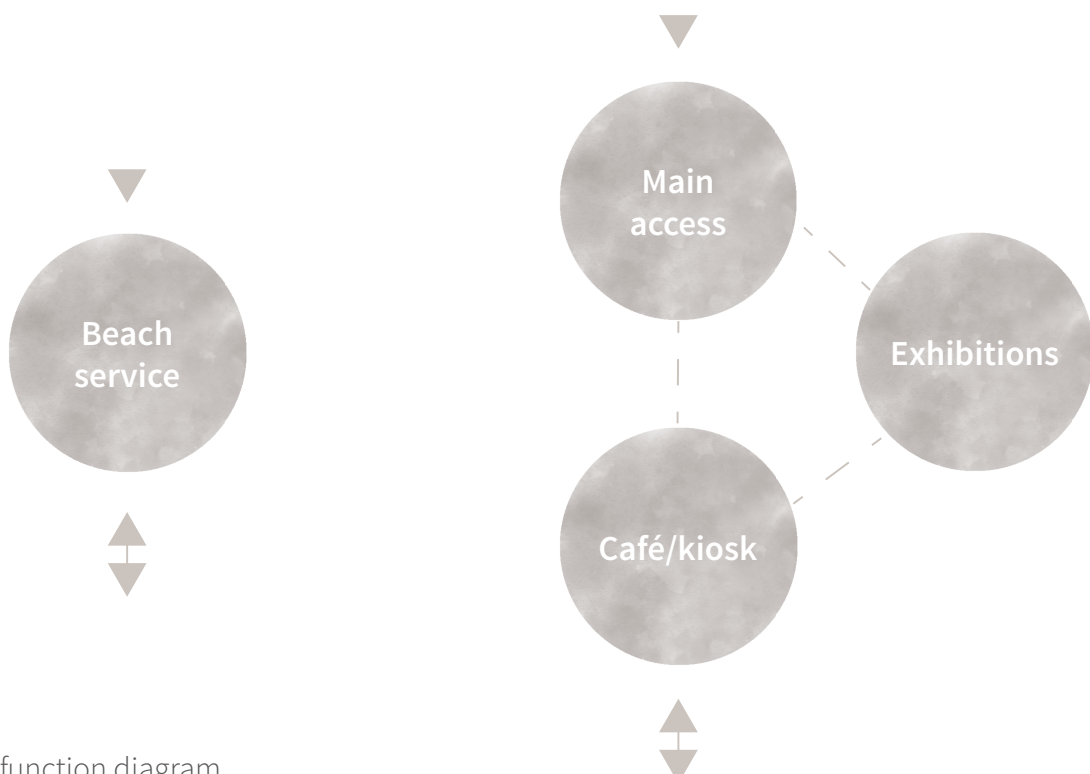

A10 function diagram

Ill. 95

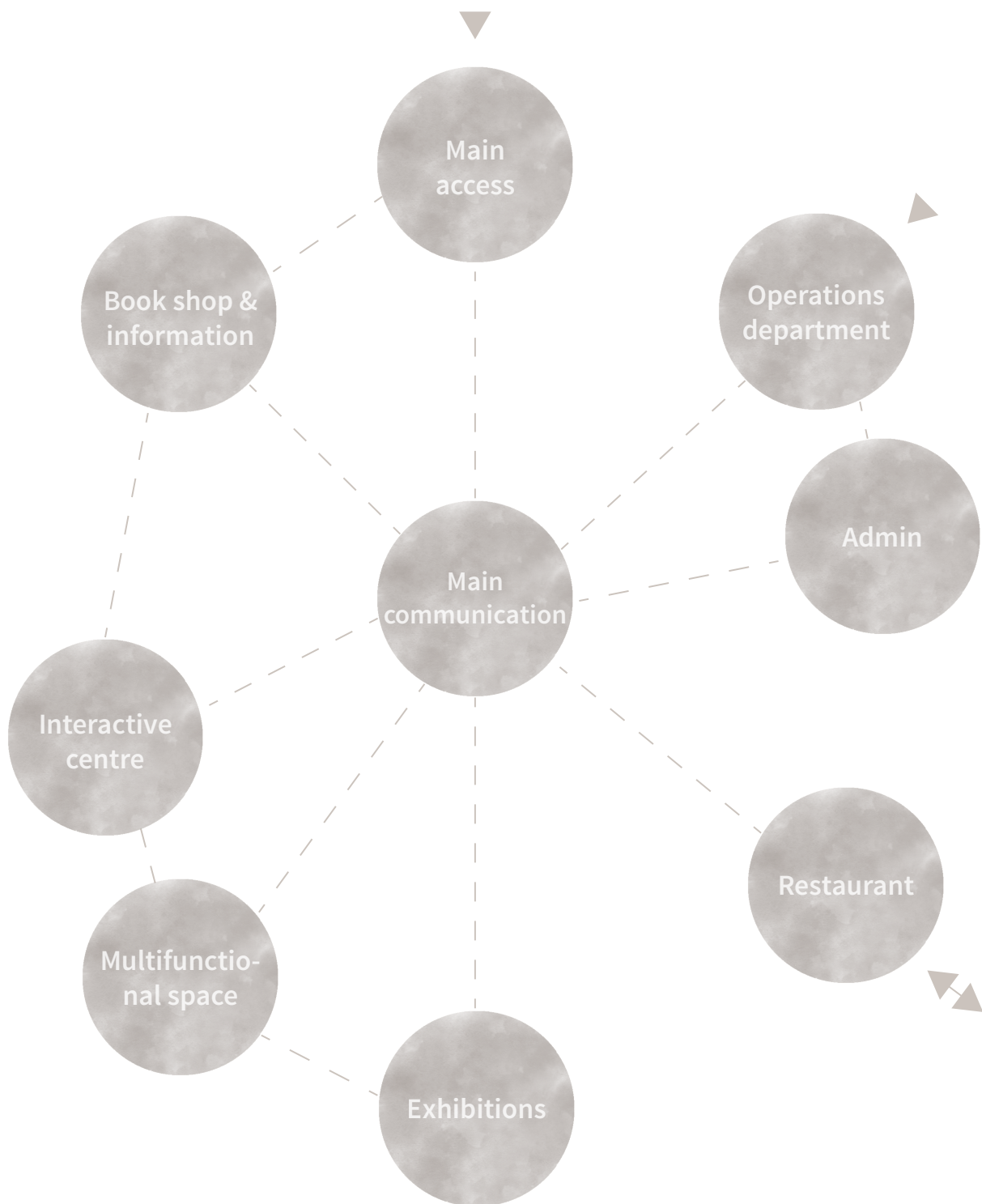

A11 function diagram

Ill. 96

ATMOSPHERE DIAGRAM

A series of atmospheric details are composed into diagrams to identify the atmosphere and spatial requirements for each room. The diagrams illustrate the most dominant atmosphere of the room. Also, the diagrams illustrate how the rooms and atmospheres are connected to each other which also shows the various atmospheres the visitor will experience. To ensure a common understanding of open words such as, “warm, cold, transparent, open etc.” reference pictures are pinned to the atmospheric description of a function which will be presented on the following pages. Defining the atmospheric compounds of a space forces the designer to consider multiple pinned aspects while physically structuring the spatial connectivity.

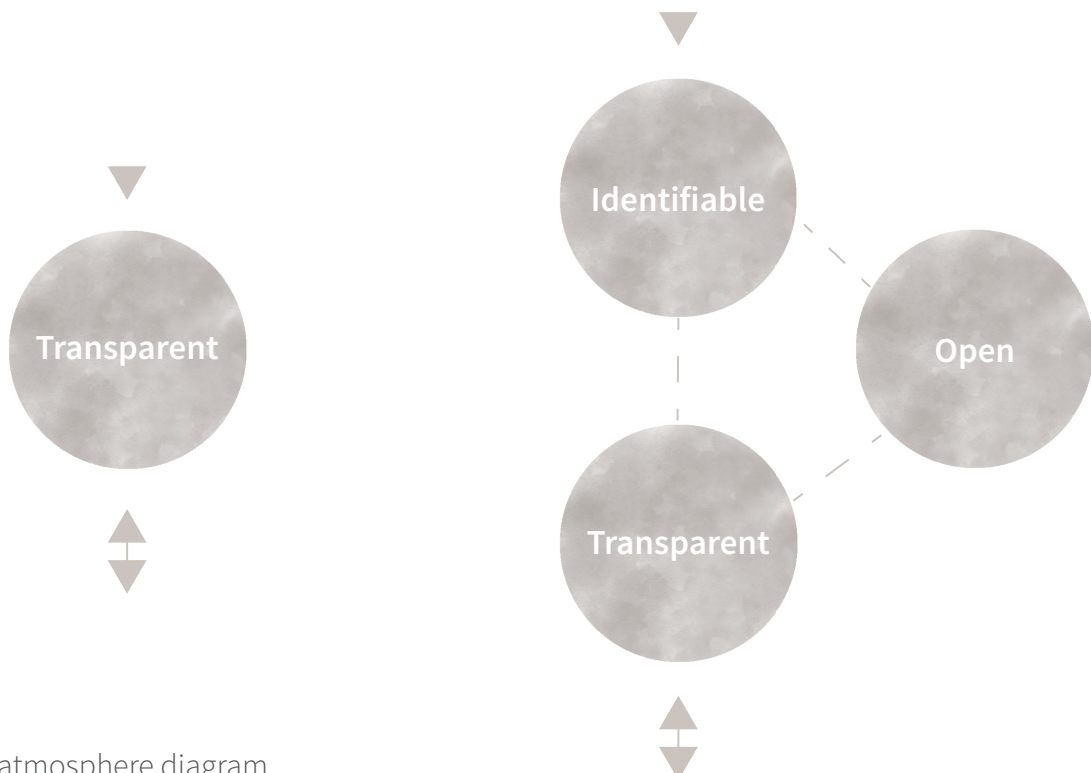

A10 atmosphere diagram

Ill. 97

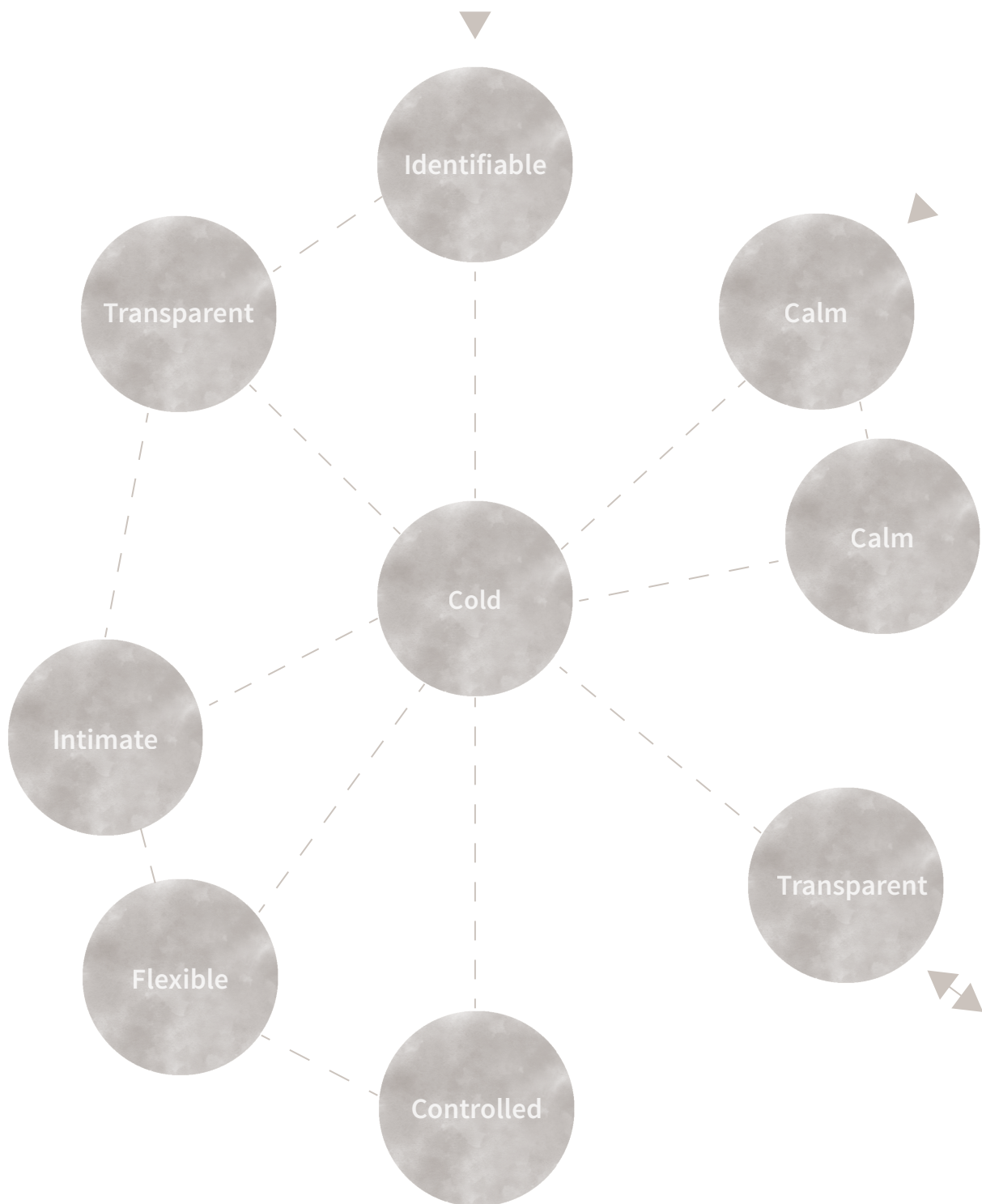

A11 atmosphere diagram

ROOM PROGRAMME

DESCRIPTION	AREAL m ²	NUMBER	TOTAL m ²
PROJECT SITE A10			
Gross area			1035
Net area			714
ARRIVAL AREA			
Vestibule	30	1	30
Ticket sale/information	10	1	10
Toilets/wardrobe	20	1	20
CAFÉ/KIOSK			
Café/kiosk	117	1	117
Kitchen/production	20	1	20
Office	6	1	6
Staff wardrobe/WC	3	2	6
Wardrobe/WC	5	2	10
EXHIBITION			
Exhibition	395	1	395
BEACH SERVICE			
Beach service	100	1	100

Ill. 100

DESCRIPTION	AREAL m ²	NUMBER	TOTAL m ²
PROJECT SITE A11			
Gross area			4108
Net area			2833
ARRIVAL AREA			
Vestibule	50	1	50
Ticket sale	15	1	15
Meeting area	60	1	60
Wardrobe/WC	40	1	40
BOOKSHOP & INFORMATION			
Bookshop & information	90	1	90
Staff wardrobe & WC	5	2	10
Storage	15	1	15
INTERACTIVE ACTIVIES KIDS			
Activity room	60	3	180
RESTAURANT/CAFÉ			
Dining area	195	1	195
Bar/finger sandwich	15	1	15
Service area	15	1	15
Kitchen area	75	1	75
Office	8	1	8
Staff wardrobe/WC	5	2	10
Wardrobe/WC	15	2	30
EXHIBITION			
Exhibition	1190	1	1190

DESCRIPTION	AREAL m ²	NUMBER	TOTAL m ²
MULTIFUNCTIONAL AREA			440
Multifunctional area	180	1	180
Black box	90	1	90
Workshop area	60	1	60
Technical control room	20	1	20
Storage for chairs	20	1	20
Storage for supplies	20	1	20
Kitchenette	20	1	20
Changing room	10	2	20
Bathroom	5	2	10
ADMINISTRATION			230
Office leader	20	1	20
Office staff	10	3	30
Flex office	30	1	30
Marketing	60	1	60
Meeting room	30	2	60
Printer room	10	1	10
Staff wardrobe/WC	10	2	20
OPERATIONS DEPARTMENT			165
Workshop	20	1	20
Cleaning room	20	1	20
Office service	15	1	15
Staff Wardrobe/WC	10	2	20
'Dry' waste	30	1	30
'Organic' waste	20	1	20
'Hazardous' waste	10	1	10
Exhibition delivery	30	1	30

III. 101

ATMOSPHERE PROGRAMME

ROOM	ATMOSPHERE	DESCRIPTION
PROJECT SITE A10		
Beach service	Open, light, casual & transparent	Open to the entire publicity and neutral in expression to not exclude a certain type.
Main access	Open, light & identifiable	The main access room must be cold and transit to navigate visitors in the direction of the three surrounding functions.
Exhibitions	Open & light	The exhibition area must be flexible in its atmosphere to support the various exhibition themes.
Café/kiosk	Open, light, transparent & identifiable	The atmosphere must emphasize the notion of “short term stays” with faster pace flow, relatable to the beach cafés.

III. 102

ROOM	ATMOSPHERE	DESCRIPTION
PROJECT SITE A11		
Main access	Open & identifiable	To ensure an eye-level based approach to the visitor, the main access area must be inviting and welcoming in its development.
Book shop	Light, warm, calm & transparent	The book shop must be manageable and provide good orientation. It must have an identifiable character to separate it from the main entrance.
Information & ticket sale	Identifiable, warm & transparent	The information and ticket sale must be in a position that doesn't disturb the flow of the building, but rather becomes a destination for the information seeking visitor.

Main communication	Cold, light, transit & transparent	The area is transit with a large room height to induce a feeling of airiness and lightness. The room becomes the primary contrast element to the connecting rooms with more intimate physical environments.
Interactive centre	Warm, intimate, energetic, creative & transparent	The interactive centers induce a playground-like atmosphere, which enables the visitors to unfold their creativity through the activities inside. The centers become semi-transparent to allow adjacent visitors to partly investigate the creative measures.
Multifunctional space	Creative, open, dark, flexible & controlled	The atmosphere of the multifunctional space varies and is determined on the premise of the use of the room.
Exhibitions	Warm, calm & controlled	The rooms must be neutral in expression to not induce a certain predefined mindset to the perceiver. Areas of contemplation and rest must be in the places in between exhibition areas. These areas allow for casual conversation to reflect upon the exhibitions.
Administration	Warm, calm & focussed	The area of administration must reflect calmness while being shielded against disturbances.
Restaurant	Warm, open & transparent	The atmosphere of the restaurant must reflect warmth and comfort to finish the journey through the exhibitions. It must be a place of communication to discuss the events without the noise traveling through the museum.

III. 103



Ill. 104



Ill. 105



Ill. 106



Ill. 107



Ill. 108 Credit: Brett Boardman



Ill. 109



designer.com

III. 110

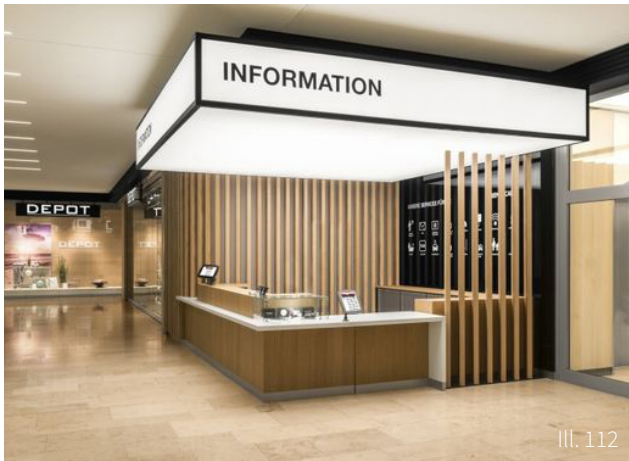

III. 112



III. 113



III. 111



III. 114



Ill. 115



Ill. 116



Ill. 117 Credit: Janez Marolt



Ill. 118 Credit: BBP Arkitekter



Ill. 119



Ill. 120 Credit: Edgard Cesar



Ill. 121 Credit: Pierangelo Laterza



Ill. 122

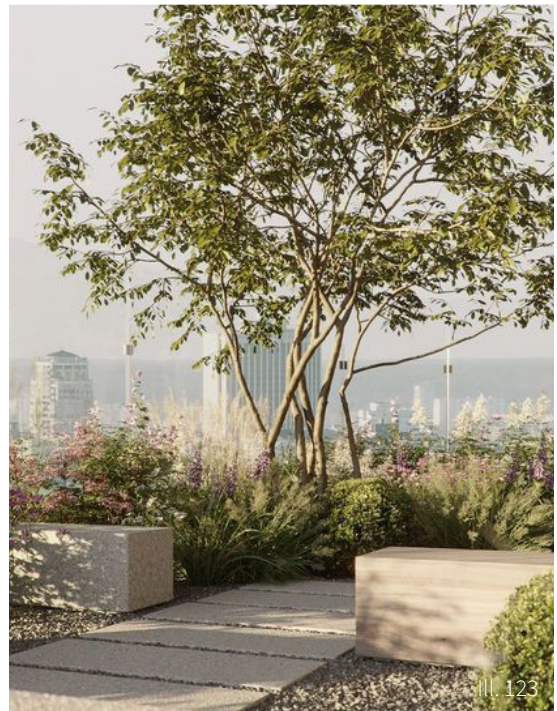

Ill. 123

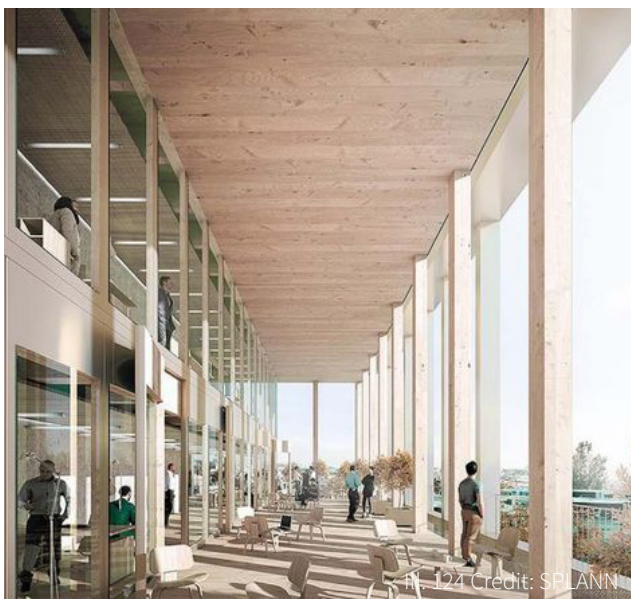

Ill. 124 Credit: SPLANN



Ill. 125

MUSEUM USAGE TIME

There is a tendency for public buildings and offices to be closed off after work hours, thereby leaving these large-scale buildings empty in the evening. The empty and often dark building due to lights being turned off when not in use, visually disturbs the city image. The darkness and lifeless buildings create an atmosphere of insecurity. There the design proposal must ensure the usage time of the building is expanded to a maximum opening hour, so it complements the users and the staff.

The facilities of the museum such as the bookshop, the restaurant, the activity rooms, and the workshop room, give the opportunity to expand beyond the opening hour for the exhibitions. The previously mentioned functions are not dependent on the exhibition, therefore, the design proposal must take into account how to develop a design that considers the functions different opening hours. Also, the museum must provide functions that are attractive during summertime as well as wintertime.

The estimated opening hours are based upon the Fotografiska museums around the world which have a long visit time to ensure as many people as possible have the opportunity to visit the museums. Also, the museums have long visit hours every day of the week instead of only focusing on weekends. Therefore, the museum must offer events and exhibitions during the whole week to ensure the building is an attraction during the workweek. This way the museum tries to favor both the citizens of Oslo as well as the large number of tourists visiting Oslo every year. The following diagrams illustrates the opening hours for the variety of functions in the museum. The large expand of opening hours ensures the museum being in use as much as possible.

- Exhibition
- Activity rooms
- Workshop
- Bookshop
- Restaurant
- Office

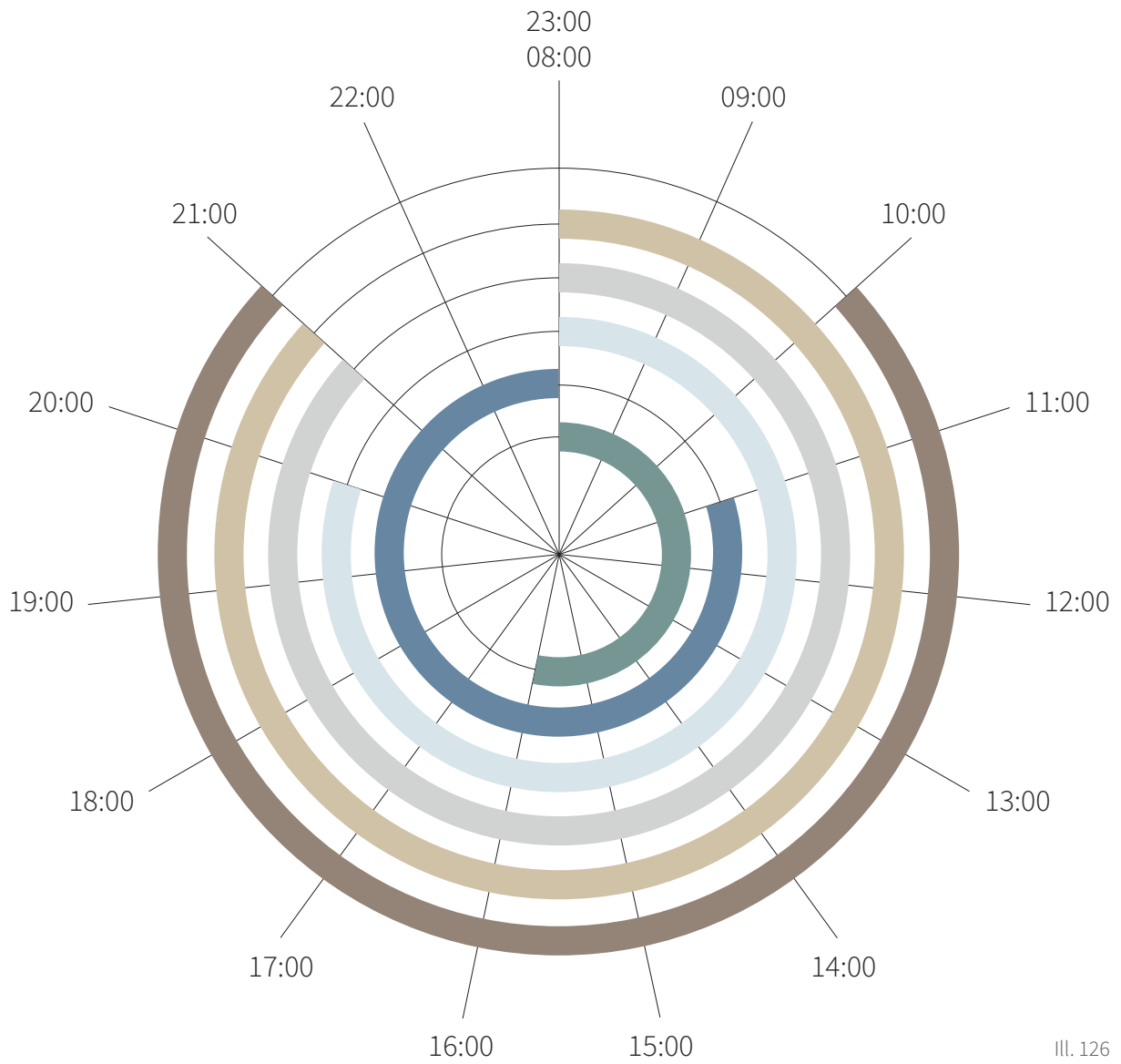

DESIGN PARAMETERS



The energy frame of the building must aim for low energy class 2020, as specified in the Danish building regulations.



The development of the building must reflect considerations of sustainable active means, which can be evaluated through DGNB, where the requirement is achieving a silver certificate.



The building's indoor climate must comply with the standards of indoor comfort class II as specified in the DS regulations.



The constructional principle of the building must reflect considerations of DfD and technical installations to be implemented in a cohesive structure while allowing for flexibility in the plan.



The building must utilize materials with low impact on the environment. Furthermore, must the material for a given surface reflect the concise purpose.

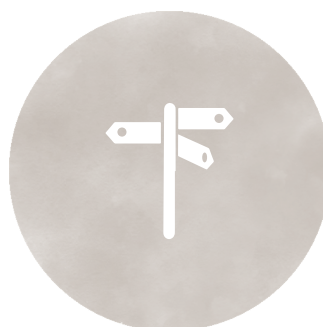

To achieve a positive experience for visitors, clear spatial legibility and wayfinding must be incorporated, also to ensure the maximum potential of the developed area.

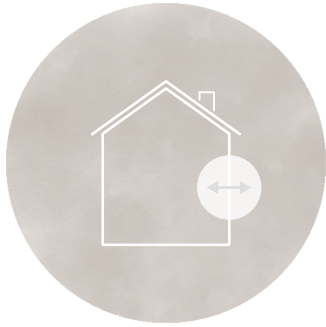

The physical environment of the buildings must relate to the city development strategy and reflect transparency, to symbiotically influence interior and exterior social experiences.



To support the vision of enhanced educational properties, the building must host several interactive educational functions such as workshop areas and information availability.



The architecture must, in its expression, programming and spatial layout support the construction of social interaction between various user groups.



The outdoor recreational areas must relate and strengthen the character of the building and increase the value of the internal rooms, while also relating to the vision of the new fjord city, and be publicly accessible and interesting for all visitors.

VISION

With the development of an asset to the cultural cluster at the new Oslo harbour front, the aim is to alter the perception of the museums' elitism. The elitism perception will be challenged through the focus of social interaction and the experimental exhibitions that includes professionals as well as amateurs to address a wide audience.

The modern approach of the museum must involve educational facilities to enlighten the public knowledge of the photograph as a media and its communicative strengths.

The architectural setting and programming of the interior, as well as exterior spaces, must become fundamental assets in creating social gatherings for the residents and tourists of Oslo. Thereby, increasing the quantity of life in the area, which improves the quality of the current harbour front.

The surrounding nature indicates a framing reference for certain activities within the building to foster the notion of contemplation through prolonged stays. Conclusively we aim to create a building that becomes a sustainable beacon for social- and cultural gathering.

EXHIBITION NARRATIVE

The purpose of establishing an exhibition area in the first place is to present a socially relevant topic for a viewer, for them to establish an opinion on the subject, which leads to discussions and possibly emotional and knowledge-based evolution. The spaces developed must not interfere with the communication of the art in any negative way.

The flexibility of the designed space must create limitless possibilities in terms of structuring the exhibition walls and directing a narrative through varying atmospheric perceptions. Architecturally, the atmospheric perception can be altered through the presence of windows, daylight, ceiling height, exposure to urban spaces, exposure to the free etc. These architectural elements must be present in the exhibition spaces to emphasize the varying perceptions.

As previously established, Tao Lytzen of PixlArt mentions the importance of digital exhibitions being present in order to have a high degree of adaptation and variety, which assists in creating a larger flow in visitors and allowing the visitors to revisit more often. Tao further emphasized the importance of creating an exhibition in varying scale, as a large-scale photograph, e.g a real-sized man in war has a very different impact on the emotional reception by the viewer, as compared to a 10" screen would have. This implies that both digital and analogue exhibition facilities must be present in the museum.

03 DESIGN PROCESS

INTRODUCTION

The design process will be structured in five separate phases, of increasing detailing and knowledge based on the hermeneutic spiral. The phases are shifting at key intervals of our process, be it a midterm critique or an important counseling session. Initially, the design process is driven through analogue sketching methods of hand drawings, manifold, foam modelling and basic cardboard pieces as functions to move around and structure. Gradually the design process becomes driven by digital sketching methods, simulations, and calculations to validate certain design decisions.

The design process was initially driven by investigating separate sections of the whole development, this could be volume studies, function placements, plan drawings, etc. This was to test various aspects and attain knowledge. This knowledge was then ultimately synthesized into plan developments of increasing quality, ultimately ending in the finalized proposal.

VOLUME STUDIES

3.1 PHASE 1

The design process' first step was to investigate shape and expression. This was done through physical foam pieces on a context model to investigate the relation between the volume at our site, compared to the Opera and the Edward Munch Museum.

The close proximity context consists of a variety of typologies, and it was concluded, that the volume placed on our site would not interfere with the rhythm of diversity, and through that, any building volume could be accepted in the context (see page 26).

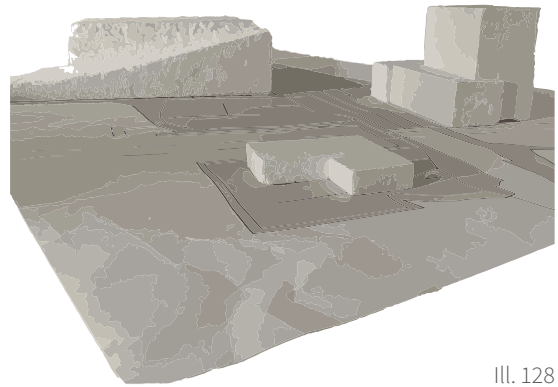

III. 128

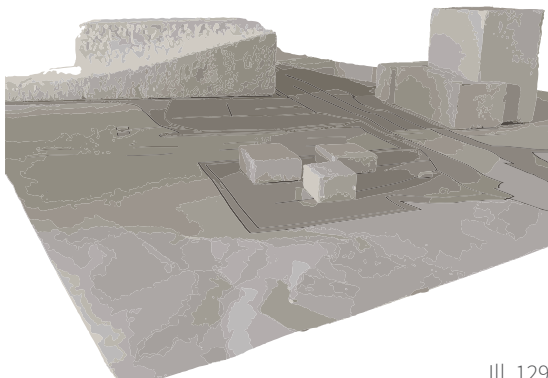

III. 129

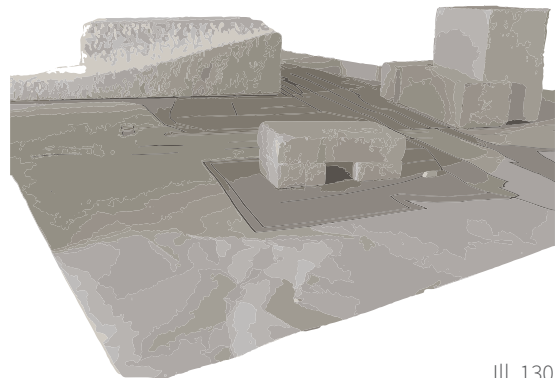

III. 130

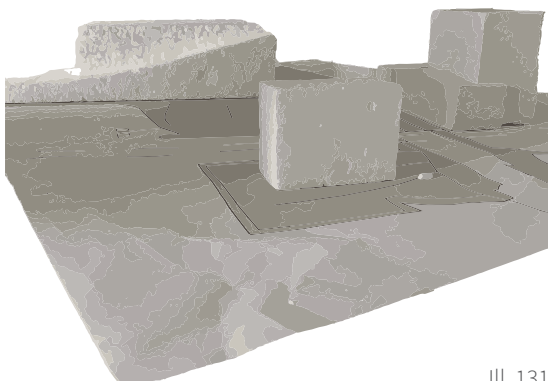

III. 131

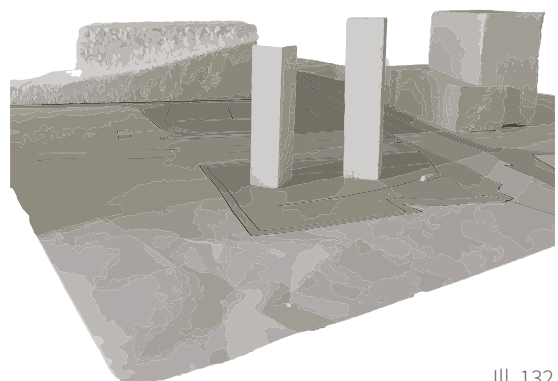

III. 132

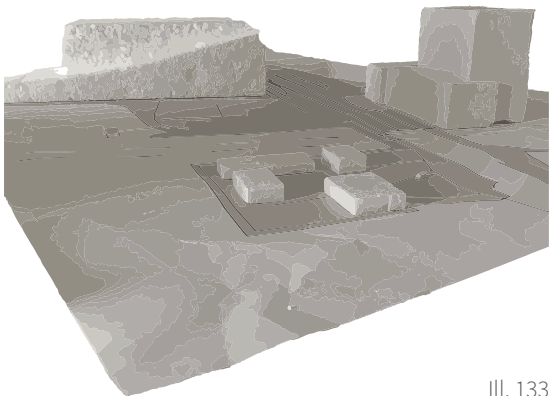
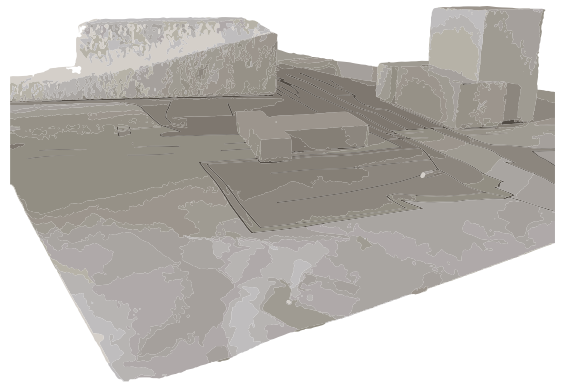
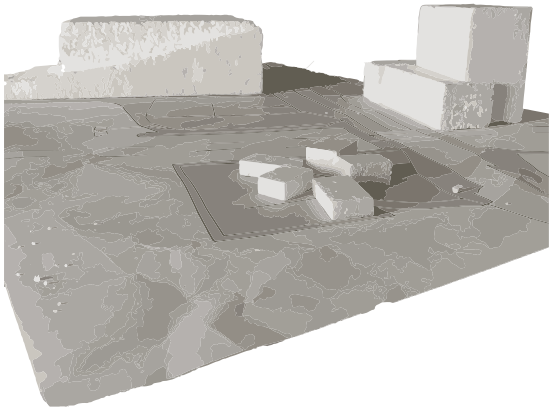

III. 133

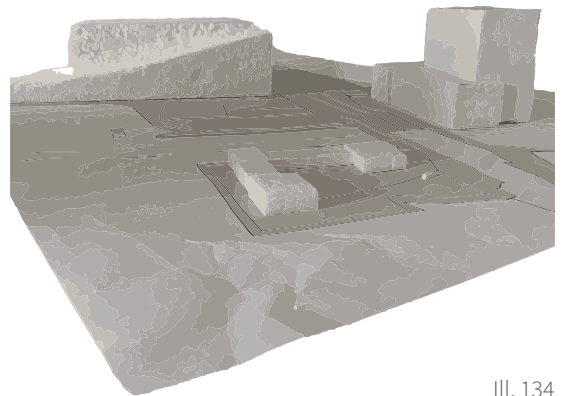

III. 134

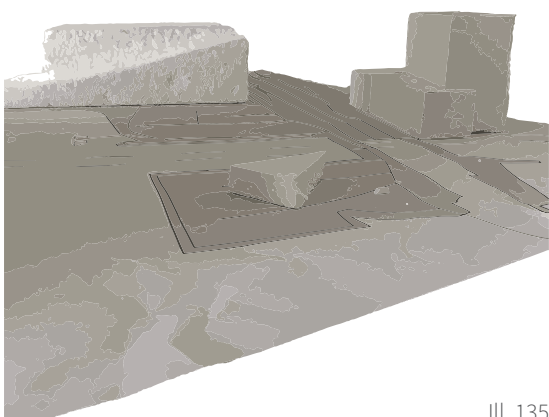

III. 135

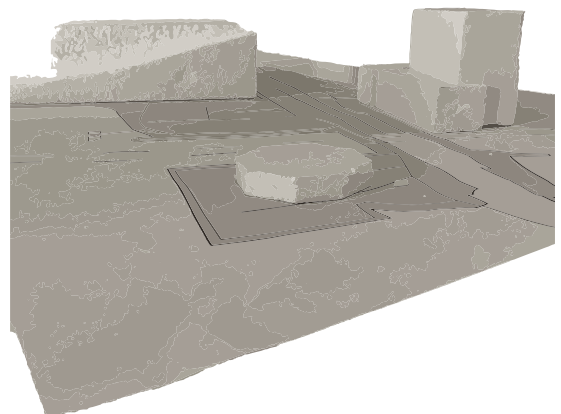

III. 136

PLACEMENT OF FUNCTIONS

3.1 PHASE 1

Working with a multitude of spaces and how they connect, how people navigate, the emotional journey, the spatial navigation, the viewpoints, and other aspects, requires a certain structure in the spatial connectivity (see page 74). To establish this structure a sequence of varied connections between the internal rooms was formed from cardboard each piece reflecting the area of the room.

This method can be form shaping but the primary purpose was to gain knowledge of how spaces should connect to establish a senseful visitor experience.

Sub-conclusion

The solution of connecting foyer, bookshop, restaurant, and information together creates the possibility of opening the building after regular hours and expanding the use time without the required attendance at the exhibition area. The multi room/blackbox in the center of the building connects the entrance and the exhibition and creates a central point from which all functions revolve. Thereby a dynamic sequence of spaces and establishes a visitor flow from which to navigate. The western section of the building is open for exhibition in various sorts. The central multi room creates a barrier that defines the activities, so beyond that border the exhibition can go wild in various directions, and the visitor will end back in known territory at the entrance area.



Ill. 137

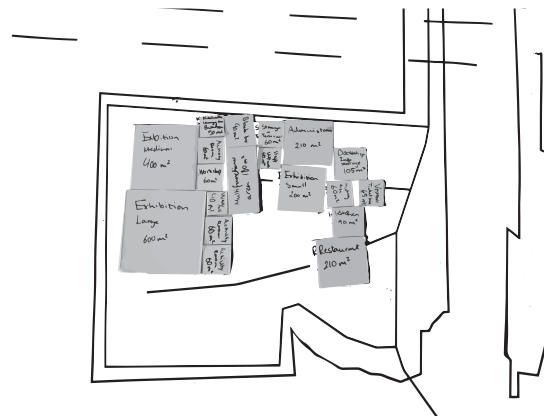

Ill. 138

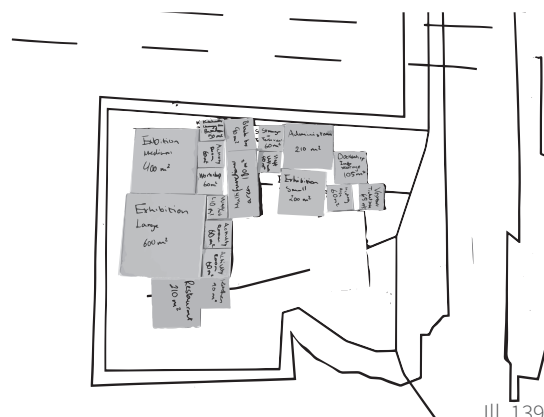

Ill. 139

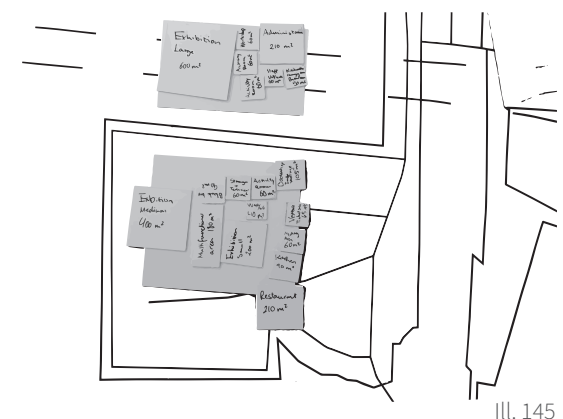
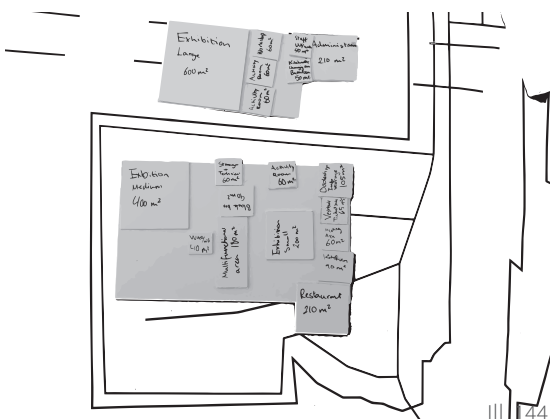
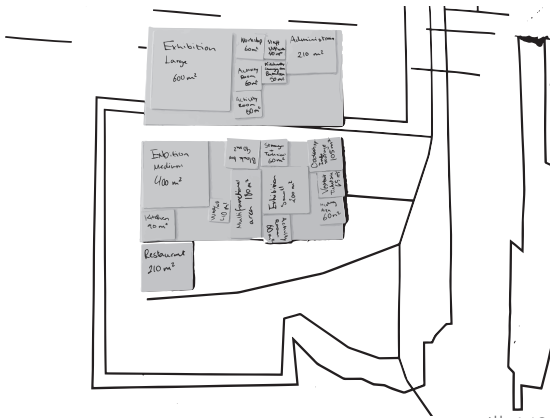
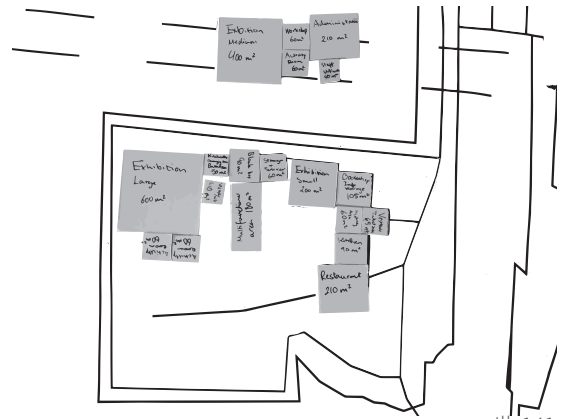

INITIAL PLAN DRAWINGS

3.1 PHASE 1

The result of working with spatial connectivity and an initial building volume resulted in the attempt at constructing a plan solution to work from. This plan solution embodies the idea of having information, bookshop, vestibule, and restaurant at the entrance area, so that the visitor has multiple options when they enter the building. The ground floor consists of the mentioned functions, with the possibility of going around the central multi room, and entering the double height exhibition area, which hosts a staircase that leads to the first floor. The first floor is initially a rather long hallway, that is intended to work as an exhibition area as the visitor moves throughout. The hallway's final destination becomes an area with activity rooms, workshop, and a small atrium to look down into the foyer area. From here the visitor can descend and enter the re-

staurant or exit the building. The northern part of the first-floor hosts office spaces for the administration sector of the House of Photography.

The volume deviates from the rectangular volume to establish an overhang towards south, both granting shelter underneath to facilitate outdoor seating for the restaurant, while also acting as a solar shading element to the building, affecting the internal solar gain and glare.

Technical installations, such as ventilation room, garbage disposal area, employee facilities, storage for photographs and materials, and storage area for kitchen and restaurant are all to be connected in a basement, as these functions add no value to the visitor. The functions are therefore moved to a separate elevation, to reduce the overall size of the building, allowing for additional urban development.

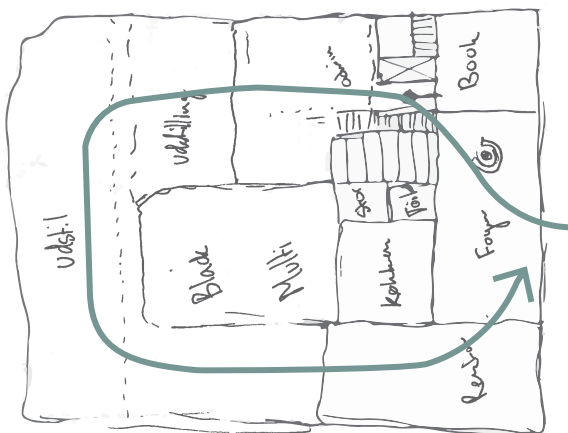

III. 146

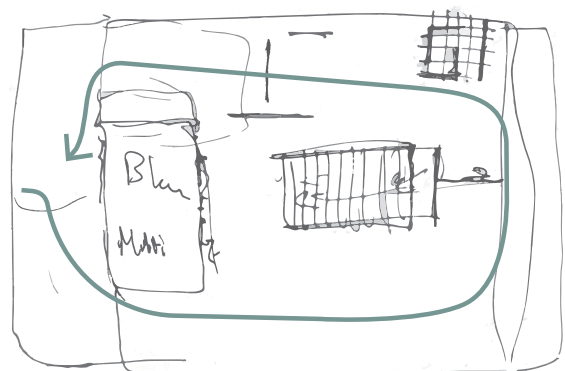

III. 147

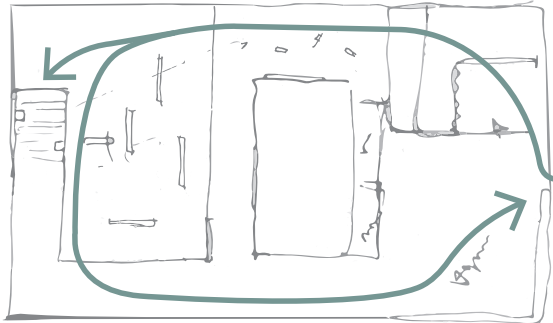

III. 148



III. 149

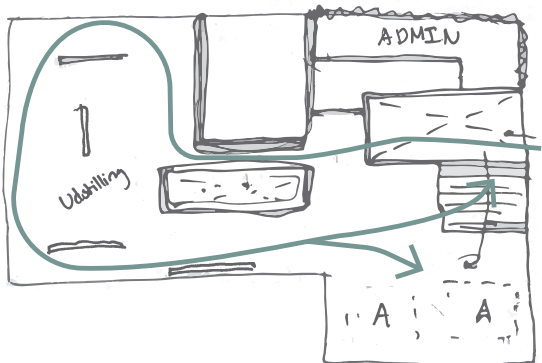

III. 150

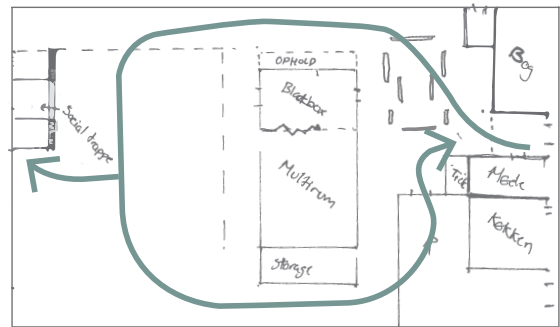

III. 151

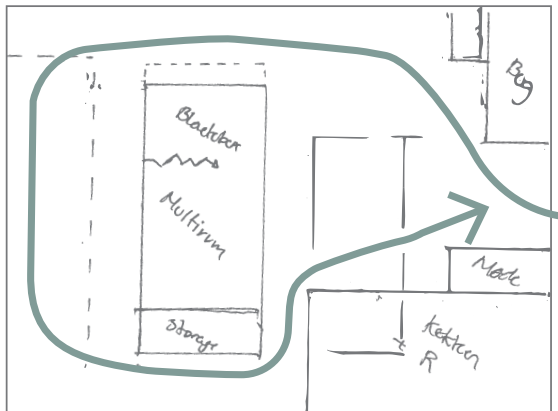

III. 152

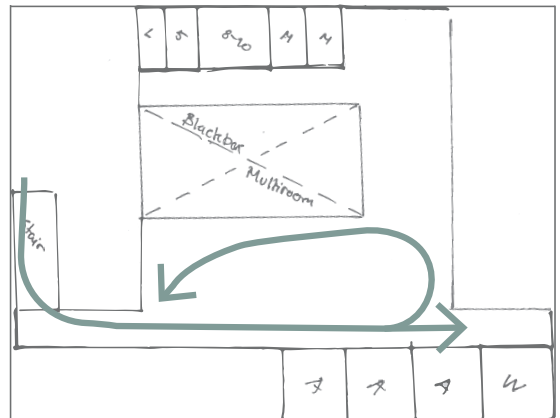

III. 153

THE STRUCTURAL GRID

3.1 PHASE 1

The constructive principle of the building is built upon a grid, and multiple aspects support the construction of a grid:

- Technical 1.4 in DGNB claims that technical installations must be flexible and allow for quick adjustment based upon the plan solution.
- Economics 2.1 in DGNB claims that the building must be flexible and can be repurposed at a later stage without large impact on the overall construction.
- DfD supports the notion of flexible construction that allows for easy dismantlement in the event of moving the building or repurposing the elements at the end-of-life stage.
- The grid allows for flexible plan solutions, which allows the House of Photography to create the exhibition areas, and tailor them to the specific setting of a given exhibition thematic.

In terms of establishing the span of the grid, the group performed a small cardboard box workshop. Cardboard boxes were assembled and stacked to replica-

te the construction of a column grid with various sizes from 2x2 meter to 8x8 meters. The purpose of this workshop was to experience the phenomenological effect the various dimensions have on flow and visitor interaction. We attempted to move past each other as couples, as singles, while one is enjoying art and moving behind them, in an attempt to investigate multiple aspects of grid dimensioning.

Sub-conclusion

The conclusion was that the sizing of 4x4 meters allowed for easy passing of two couples, easy passage of a couple behind one person perceiving the photographs, the exhibition potential in between the grid was good. The sizing further ensured that the spacing of the columns would not dominate the spatial experience. The material choice of the construction is wood, based on DGNB environmental 1.1 and 1.3, as well as analyses within the branch of timber construction, this also allows for interesting joints and supporting DfD.

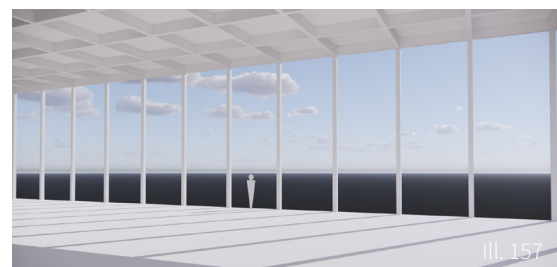
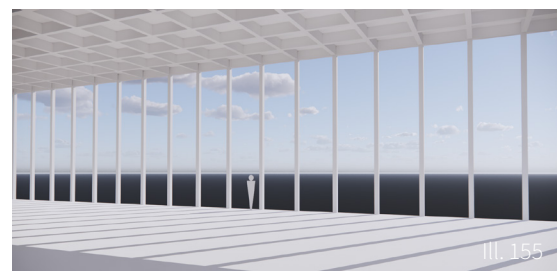

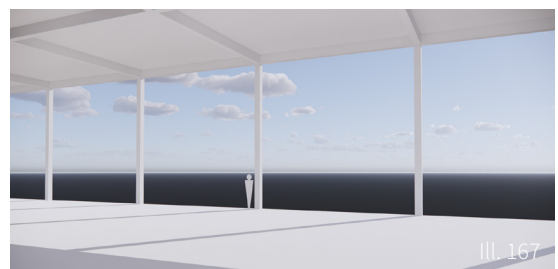
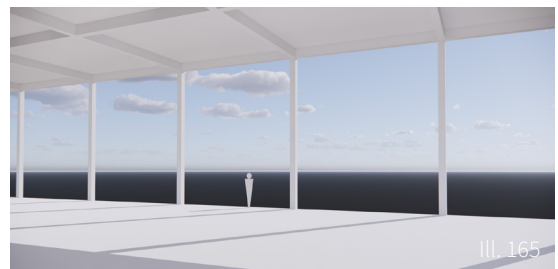
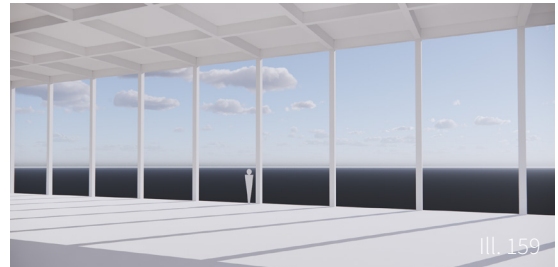

SUB-CONCLUSION

3.1 PHASE 1

The exhibition areas require full control of the lighting to be optimal, and this guided the design towards sheltering off from daylight and direct sunlight as these factors vary during the day and year while also being uncontrollable. This became a dilemma between creating the optimal conditions for the exhibition, and establishing the transparency so dearly wished from the House of Photography, but also the health-related benefits of human exposure to sunlight.

From interviews with Tao Lytzen of PixlArt in Østervrå, as well as supervision with Zakaria Djebbara the notion of “The building must be the facilitator of art, not the art piece itself.” arose, which means that the functions of the programme come before the artistic aesthetic in the architectural expression.

The building at this point was with very little contextual relation, which had to be improved drastically as the building could

be placed anywhere in the world and still have the same impression and form. This takes away from the genius loci and the sense of placement.

The advice of the supervision was to investigate a certain architectural position or style, as it might give indications to material, spatial sequencing and how to work with light.

Clearly identify the problem statement and the purpose of the visitor. This is to further identify the building's placement in society, and from this consideration, the strong emphasis on educational aspects of youths and elders alike was born.

These considerations above conclude the first phase of the design process. The phase provided strong knowledge on functional programming, phenomenological presence of grids, volumes, and their initial sustainable potential, and provided guidance as to which issues to address.

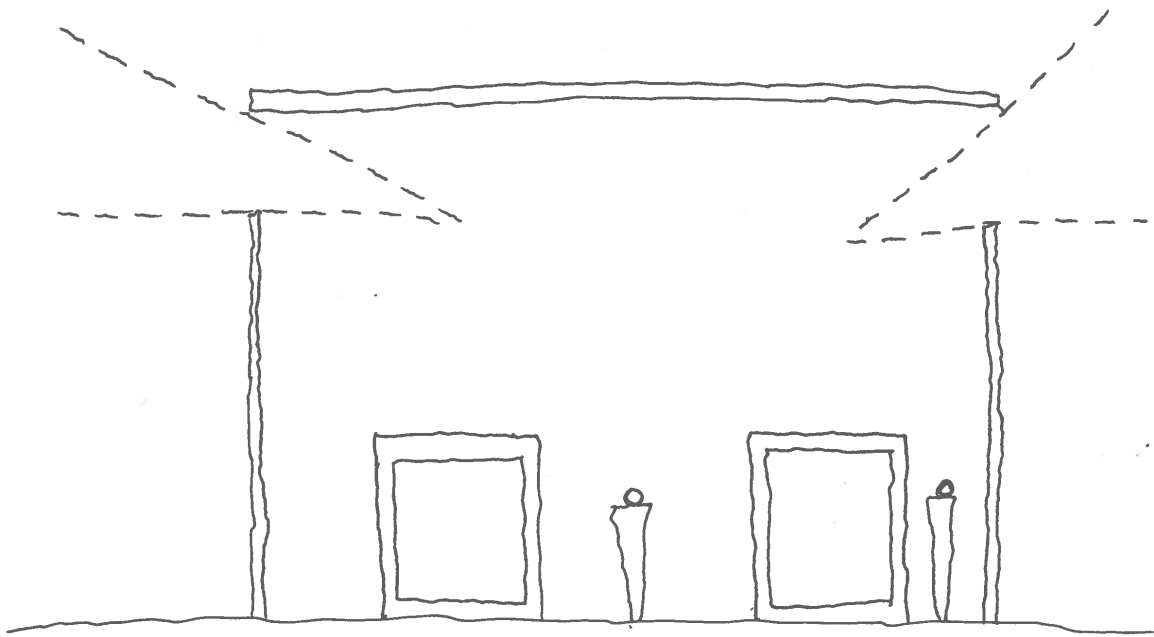

Ill. 167

ATMOSPHERE PROGRAMMING

3.2 PHASE 2

First phase of the design process shows that the museum hosts two major functions, activity, and contemplation. On one hand, activity provides the functions that encourage people to communicate and in-

teract. These functions are reflected in the vestibule, the bookshop, the restaurant, lounge areas and the activity rooms. The contemplation aspects of the museum are reflected in the exhibitions and the mul-

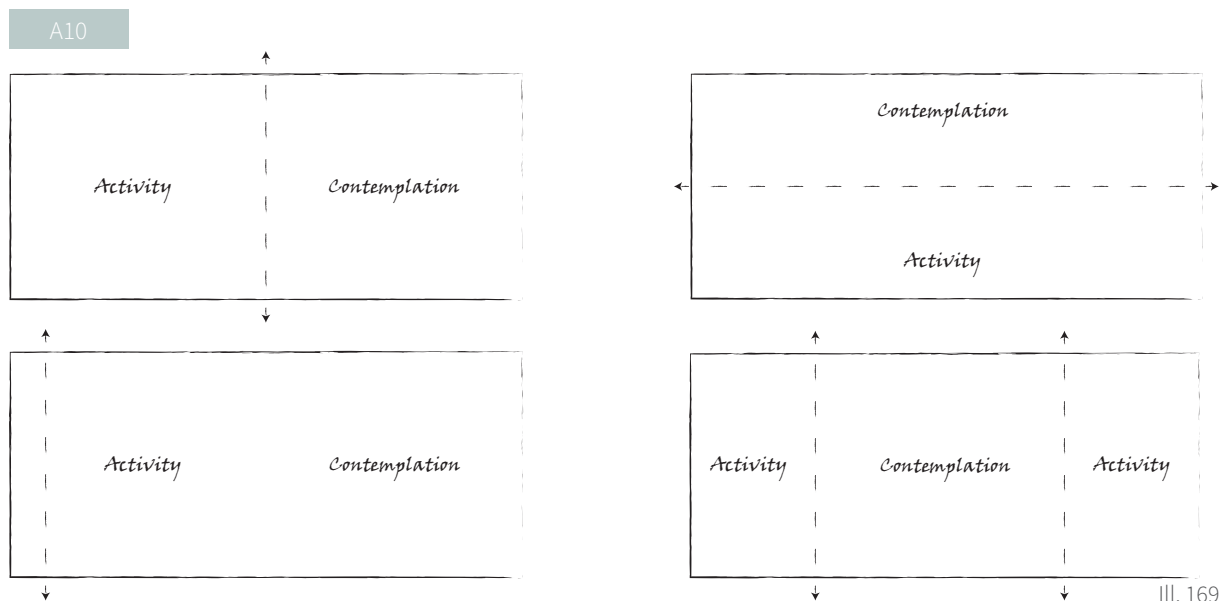
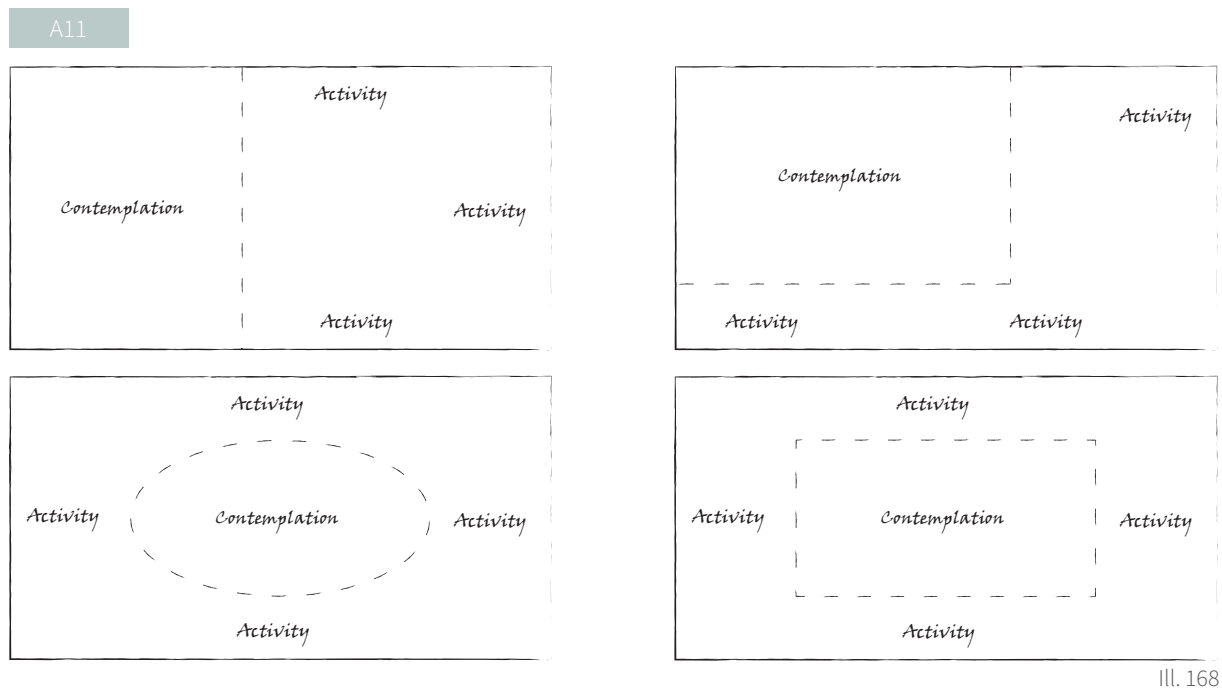

ti room with its duality in exhibition and educational properties through lectures and presentations. The contemplation facilities act as catalysts for the social interaction in the activity areas. This connectivity between the functions spawns the need for an investigation in how to place the two in accordance with each other. The following connectivity shows the conditions at A10, the smaller building, with the punctured line reflecting a passageway through the building. The building contains the exhibition area as contemplation, with café and beach service area being the activity.

Sub-conclusion

The structure selected at this point of the process is the slightly fractured connectivity, as this facilitates many positions of social interaction through the active discussion or pondering on the various contemplative art exhibitions. Multiple theories also support the claim of having the “empty rooms” or the pause areas in between exhibition halls to ponder, process and reflect on the exhibition before entering the next, allowing for improved visitor experience and distinguishing between the perceived exhibitions.

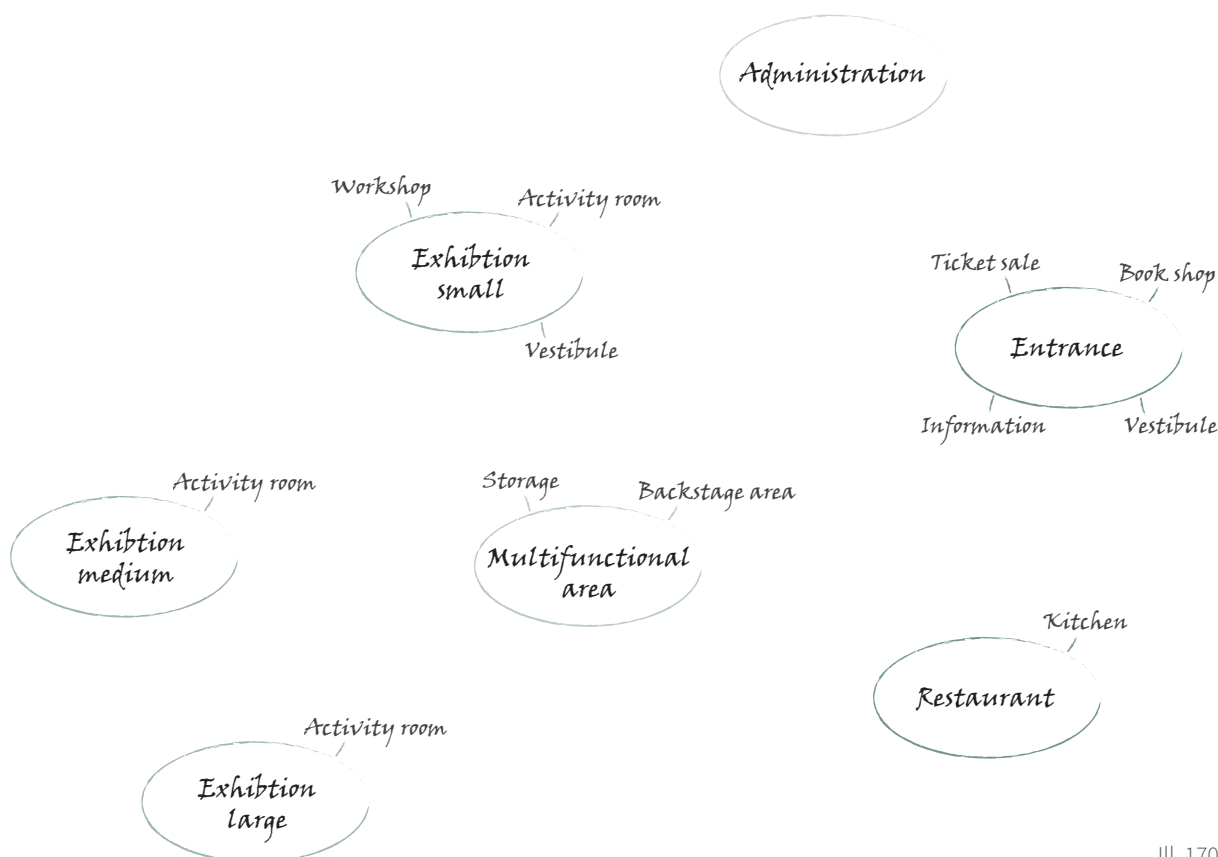

VOLUME STUDIES

3.2 PHASE 2

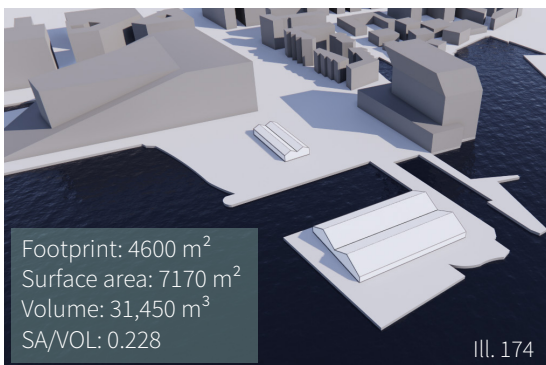
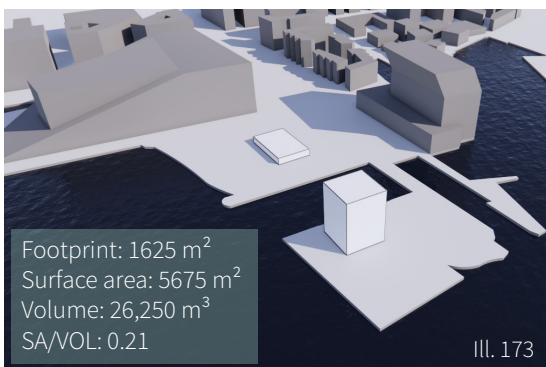
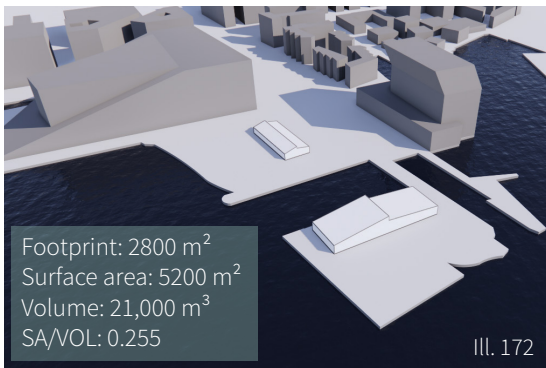
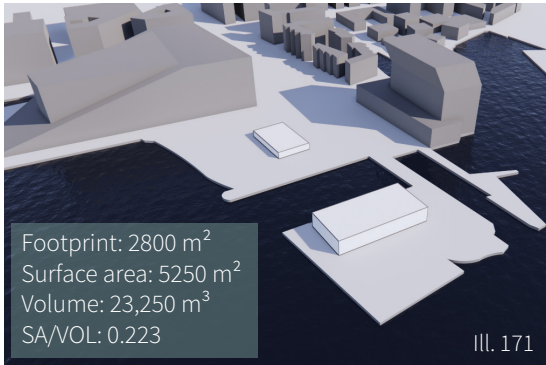

A volume study is initiated to investigate the variations in room, volume, and their contextual relevance.

The second volume study performed in the design process, has the purpose of establishing the initial sustainable potential of various typologies of the same gross area. The initial sustainable potential is based upon the material consumption of the five facade elements, in consideration to their internal volume. The facade area and volume also largely impact temperature stability and the degree of fluctuation, energy consumption and possibilities of controlling the indoor environment.

This study covers a brief study in rectangular buildings, circular buildings, fractured variations of both, tower typology, a mixed typology, A-frame, and a variation of the A-frame. A low surface to volume ratio is preferred, as that will indicate a more efficient cohesion of the two.

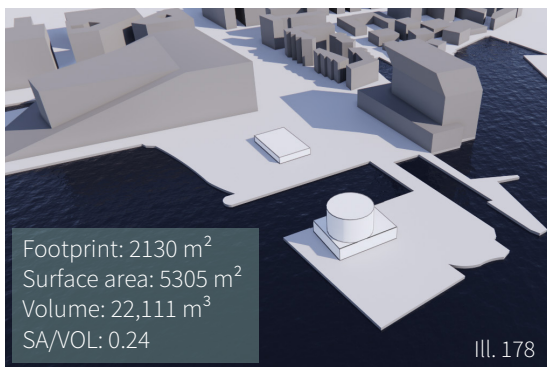
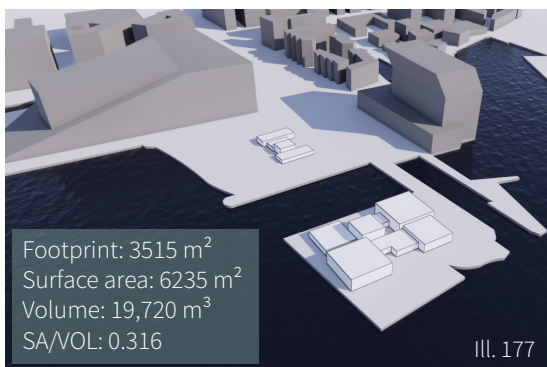
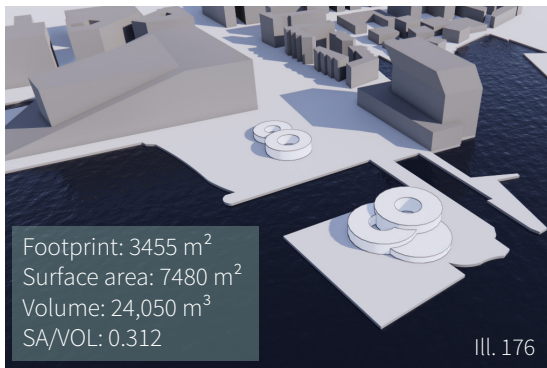
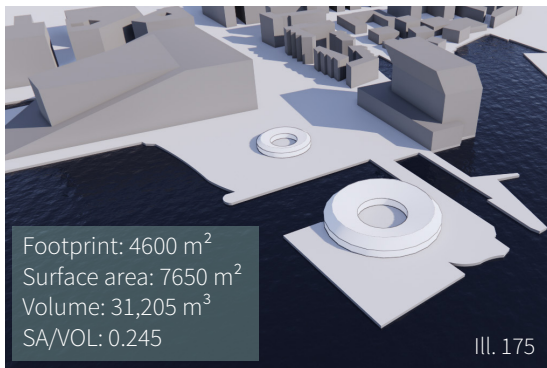

Sub-conclusion

The building typologies have the same gross area to be comparable. The surface area and volume of the different proposals vary, and the surface to volume ratio is established to make the proposals comparable. From the ratio it becomes evident that fractured design proposals are inferior to more composed proposals. The shape and orientation influence the usability of the remaining site largely. The circular proposals impose a large footprint on the site and creates the internal atrium which exposes people using them and separates the urban development into fragments. To create more connected urban developments, the circular shape should be placed closer to, or in, the water, disturbing the consideration of visual connection along the facades. The rectangular proposal imposes low footprint on the site and supports the consideration of visual connection while also having the lowest surface to volume ratio, and thereby becomes the proposal with the best initial sustainable potential.

PLAN DRAWINGS

3.2 PHASE 2

In this phase, the concept of developing a tower typology was examined. The benefit of the tower is that the spatial navigation becomes clear and concise with vertically stacked functions, and it becomes evident that this is a solution friendly for the unfamiliar visitors. Vertical stacked functions indicate that one floor hosts one overall function, such as the activity rooms and workshop, multi room and foyer, exhibition rooms, office spaces and restaurant. Circulation is the main issue in this vertical concept, with enforcing the requirement of transporting visitors far up on stairs. The excessive amount of circulation becomes dominant in the plan as well as the facades. However, the closed facade element of the office circulation core creates the possibility of exterior projection on a wall element, which has potential in terms of supporting the character development of the building. The tower typology was put on hold, as the design process continued working with the rectangular building typology.

Sub-conclusion

The rectangular plan solution resembles the one from phase 1, however, the multi room has been flipped to create spaces north and south for functions. The eastern part of the multi room contains a telescope tribune, technical room, and storage facilities, and the closed off walls are then backdrop for the information and toilet facilities. The core principle of the multi room is full flexibility, and it is intended that the walls on the ground floor can be fully opened to allow light and multiple entry points. The exhibition design surrounds the multi room, fulfilling the beads on a string method, and establishing a flow of exhibitions. The flow is branching halfway through the exhibition, allowing the visitor to go upstairs, following a hallway of art until a platform is reached. On this platform the main purpose is experimental exhibition with the results of the activity rooms and workshop showcased. The northern section of first floor is offices.

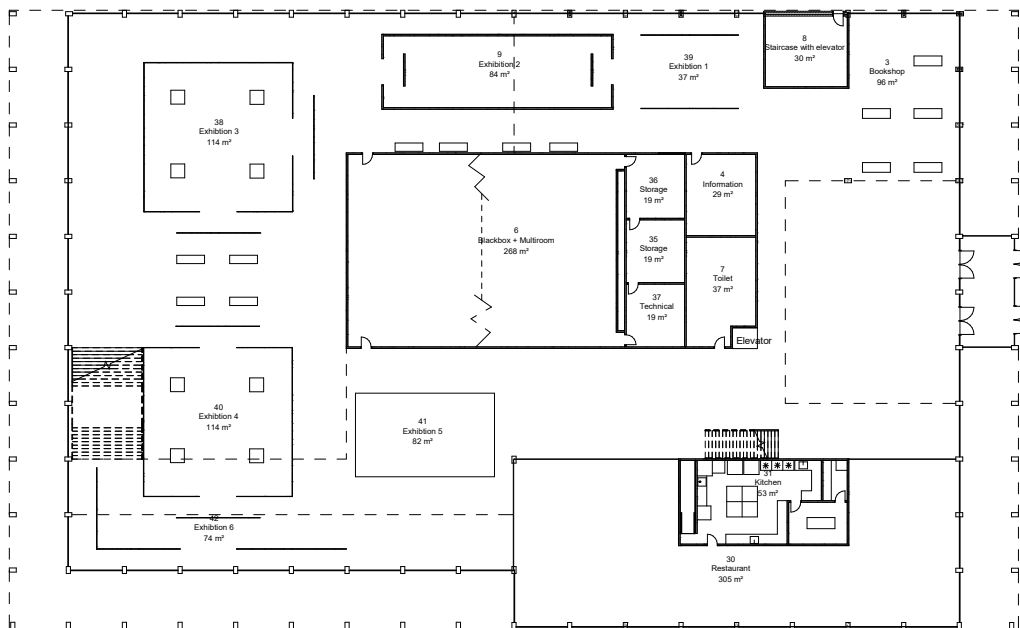

III. 179

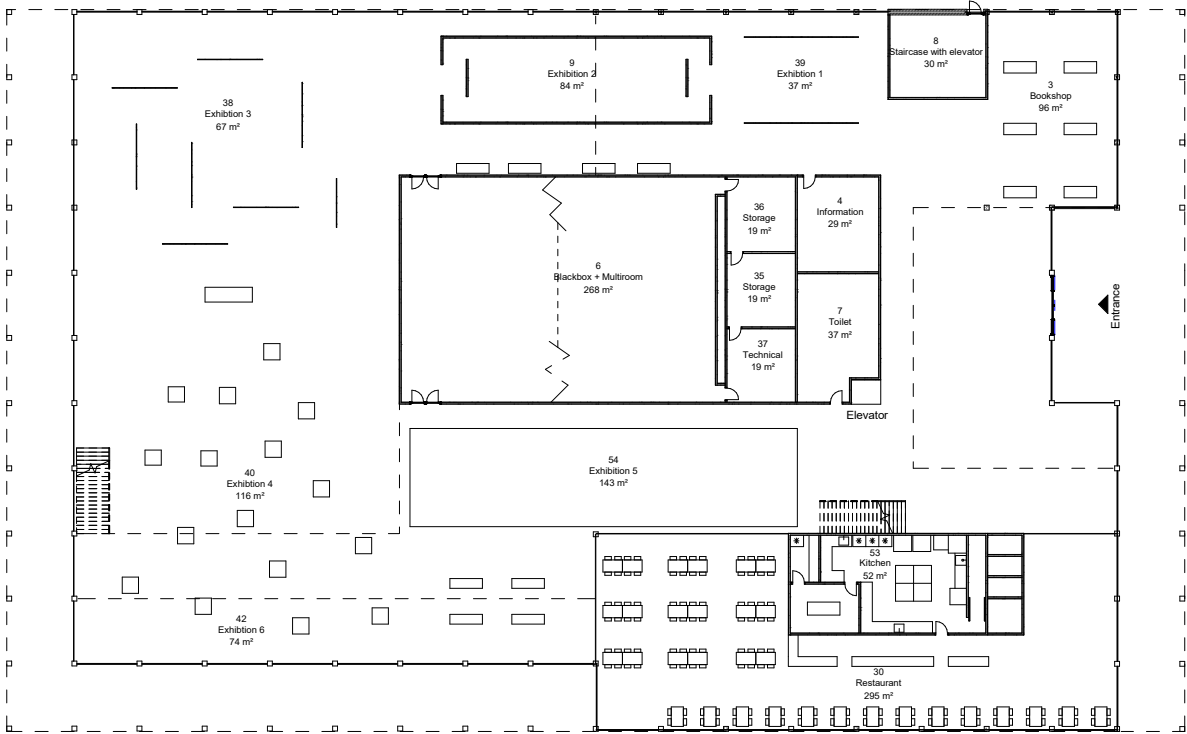

III. 180

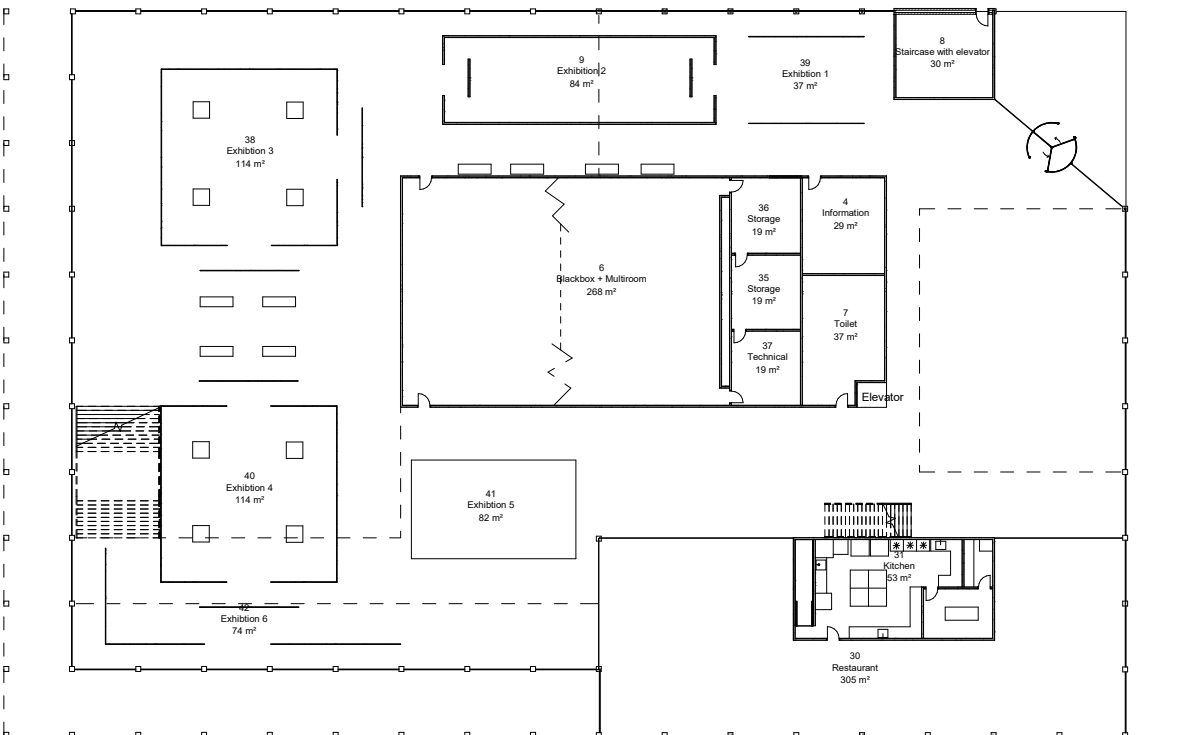

III. 181

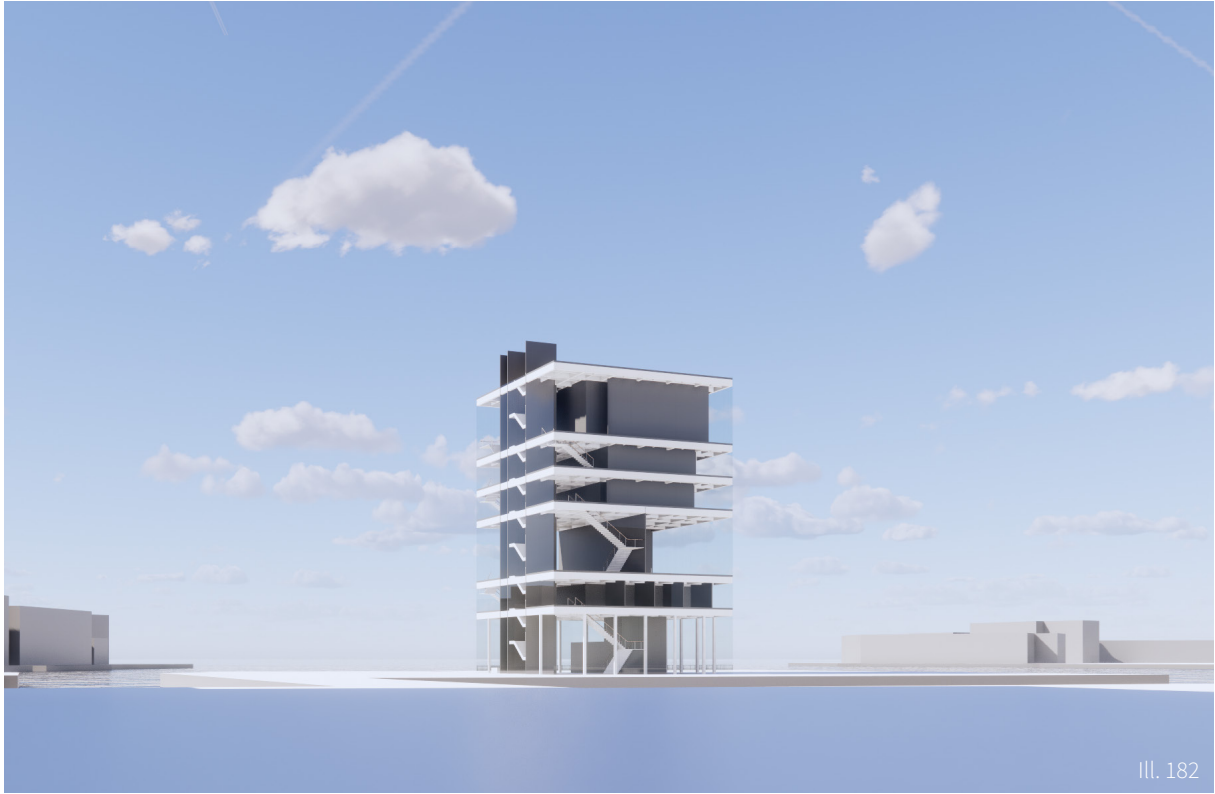

III. 182

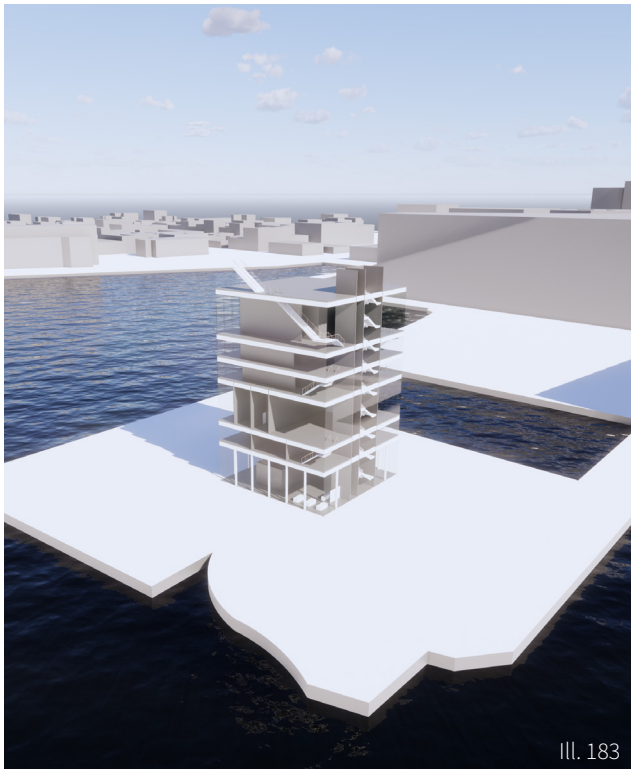

III. 183

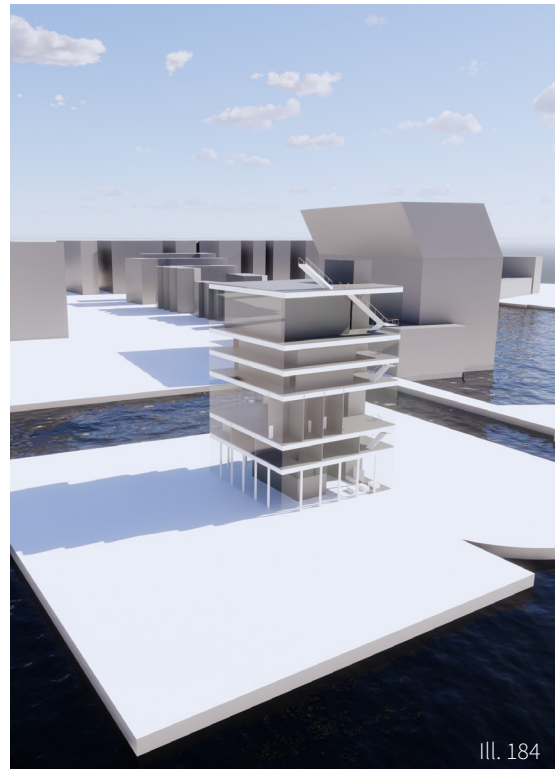

III. 184

ENTRANCE

3.2 PHASE 2

The entrance of the museum must be identifiable from a distance, and easily distinguished to provide adequate navigation for visitors. Various methods create the easily distinguishable, however, they vary in architectural expression, and must relate itself to the facade in a sense that rhythm and tact continues to create a holistic solution. The methods examined for these design proposals consisted of additive and subtractive principles, of adding a semi-transparent volume at the entrance area, which creates external spaces on both sides, providing the possibility of having bicycle parking close, or having sheltered occupational areas with varying purposes. This method creates an easily distinguish-

able entrance with little impact on the internal plan solution. A second method was to subtract material from the surface, creating a syphoning effect that drags people into the interior space. This method creates internal spaces on each side of the entrance area, assisting in diving the space into functional areas without establishing solid walls or elevation shifts.

Sub-conclusion

Conclusively the decision befell on subtracting volume to create the internal divisions without the addition of solid walls. The variation in the straight and rhythmic facade creates an easily distinguishable entrance.

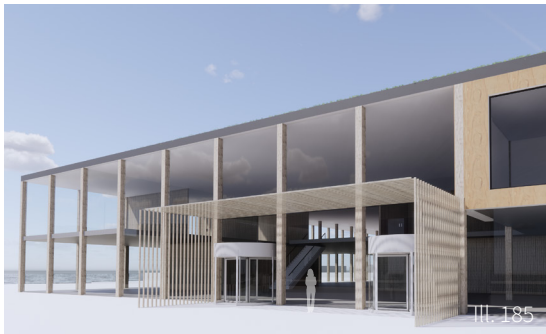

DAYLIGHT ANALYSIS

3.2 PHASE 2

The daylight was analyzed on the final proposal for phase 2, to investigate whether there are any critical areas present, and to investigate the overall daylight conditions. The results from the analysis showed that the exhibition areas were exposed to too much daylight and direct sunlight. This came from the transparent facade and simultaneously made it difficult to have a controlled environment in the exhibition in terms of lighting and atmosphere. The analysis also showed that the office area

had acceptable daylight conditions, which are 4-5% DF in the different offices. Because of the adequate daylight conditions in the office, the same window dimension could be implemented further in the design process, to be able to maintain the daylight conditions. The daylight conditions in the exhibition areas showed that in order to create a controlled environment, less transparency in the facades is required.

Daylight factor

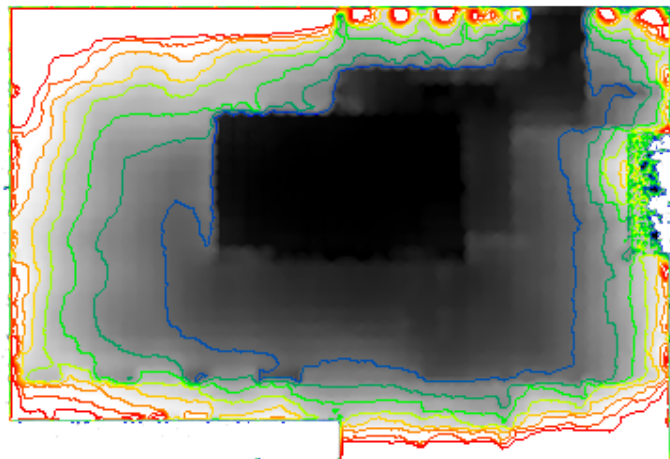
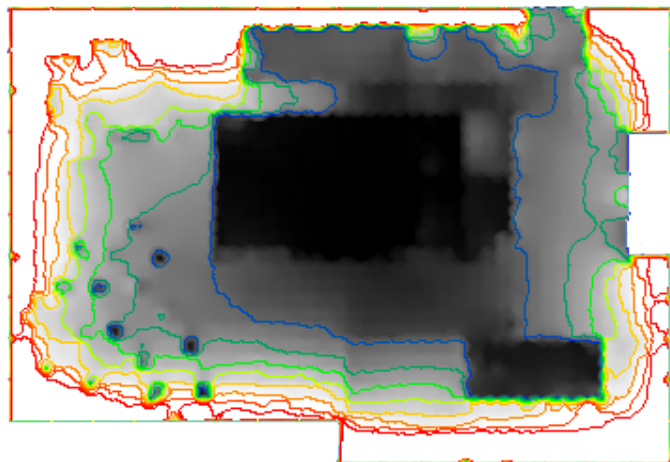

SUB-CONCLUSION

3.2 PHASE 2

The second phase of the design process enlightened the importance of implementing the “empty rooms” in between the exhibitions to increase the visitor experience, while also allowing for degrees of freedom in terms of flow. The importance of an easily distinguishable entrance became evident, and it became distinguishable by creating a change in the rhythm and tact of the facade. The examination of the tower typology indicated a potential in projecting on a larger volume to allow visitors and people close by to quickly identify the purpose of the building, while also being able to perceive art.

The most imminent problem to deal with became evident after the midterm critique, where Lars Juul Thiiis, partner of CUBO Architects, and Lars Brorson Fich commented on the contextual irrelevance the building has. The next step of the design process is to examine the activation of the fifth facade, as the building is relatively low compared to the close context, the surrounding buildings provide views down on the building, so the roof must become activated and provide qualities to the House of Photography.

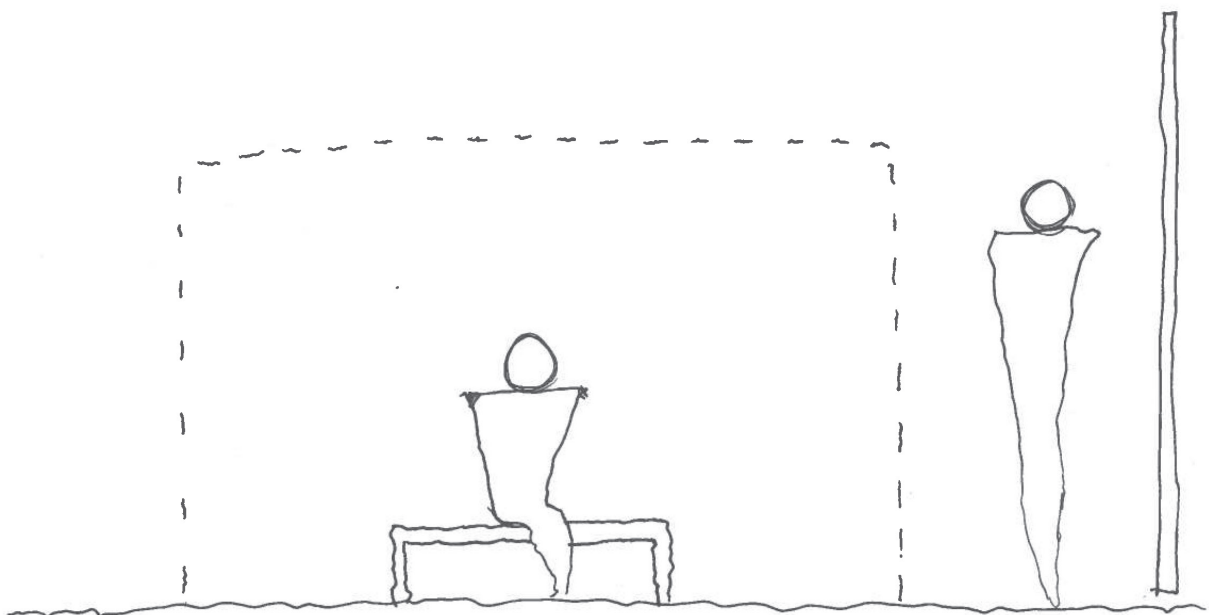

III. 190

THE FIRST PROPOSAL

3.3 PHASE 3

The second phase concluded that the building proposal lacked contextual relevance. To activate the fifth facade, the southeastern corner of the roofscape sloped to ground level, mimicking the mountainscape south of the building site. This proposal created a passage that leads people up on the roof. However, this sudden implementation of a drastic incision created interior spaces of inferior quality beneath

the slope. The surface also did not relate itself to the interior function and could have been placed on a factory, a shop, or a power supply building with the same relevance as for the House of Photography. Also, there is a fear that this secondary function would end up being the primary function of the building, as has been seen with Henning Larsen's Moesgaard museum. The identity of the House of Photo-

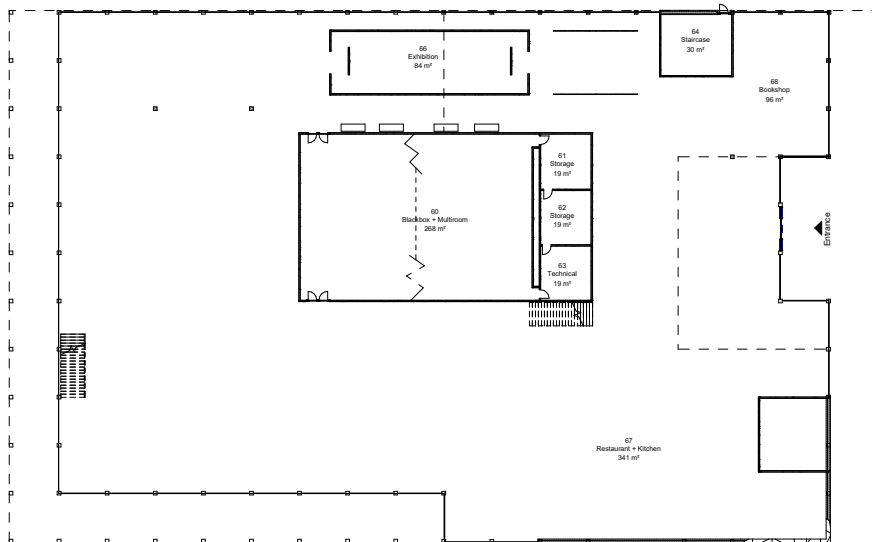

Ill. 191

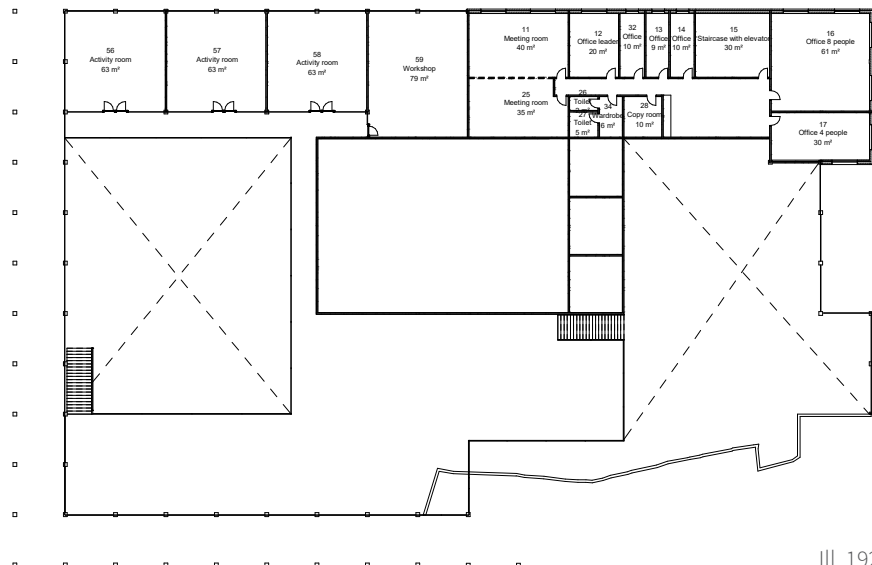

Ill. 192

graphy would quickly develop into “I think it was that house down on the harbour where you could walk on the roof” instead of being a landmark for the cultural function it hosts. The overall idea of activating the fifth facade as an urban space supports DGNB criteria such as SOC 1.6, 2.1, and 2.2 regarding urban spaces and accessibility.

The plan of the first proposal was an at-

tempt at continuing the former plan from phase 2, but the interior spaces lost their value and this had to be addressed. Initially, the activity rooms were moved from the southeast to the northwest, this created an atrium in which the main exhibition was. The activity rooms however were too far from the entrance and created disturbances in the balance of contemplation and activity.

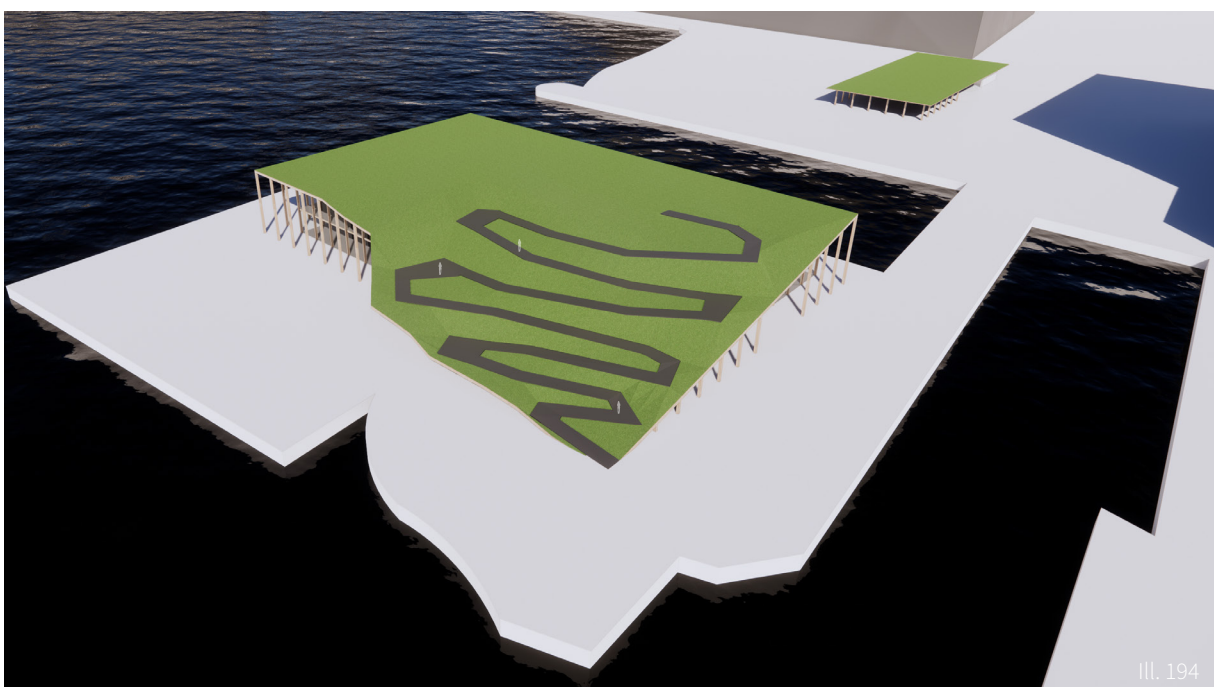
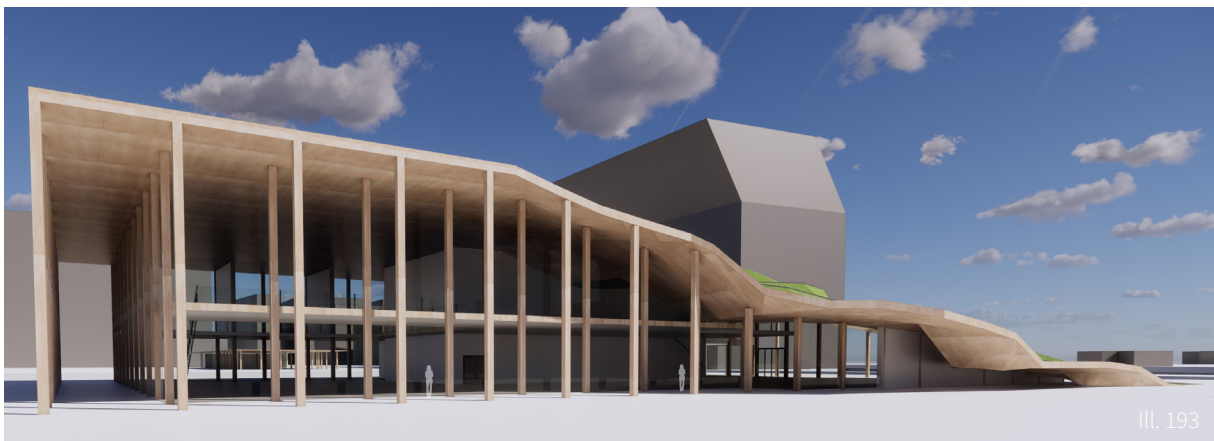

THE SECOND PROPOSAL

3.3 PHASE 3

The design of the second roofscape rearranged functions by moving the entrance point from the southeastern corner to the southwestern corner, while also utilizing the entire roof and transforming it into a ramp-like form. The movement of the entrance point as well as easing the overall shape of the roof was to underline that the roof should be a secondary function, and add value to the interior room below. The slope from the ground enabled the idea of lowering an exhibition space under floor level, thereby creating a room that was more controlled in terms of lighting. The

activity rooms were moved to be along the northern facade, close to the entrance, and together with the multiroom and offices, enveloped an exhibition space. At this point, the building no longer had any functions on the first floor and was strictly eye-level activities. This was done to allow more freedom in the facade and create a visual balance.

The rotation of the multiroom was done to create a board on the roof, which together with a tribune would create an outdoor exhibition space to emphasize the character of photography.

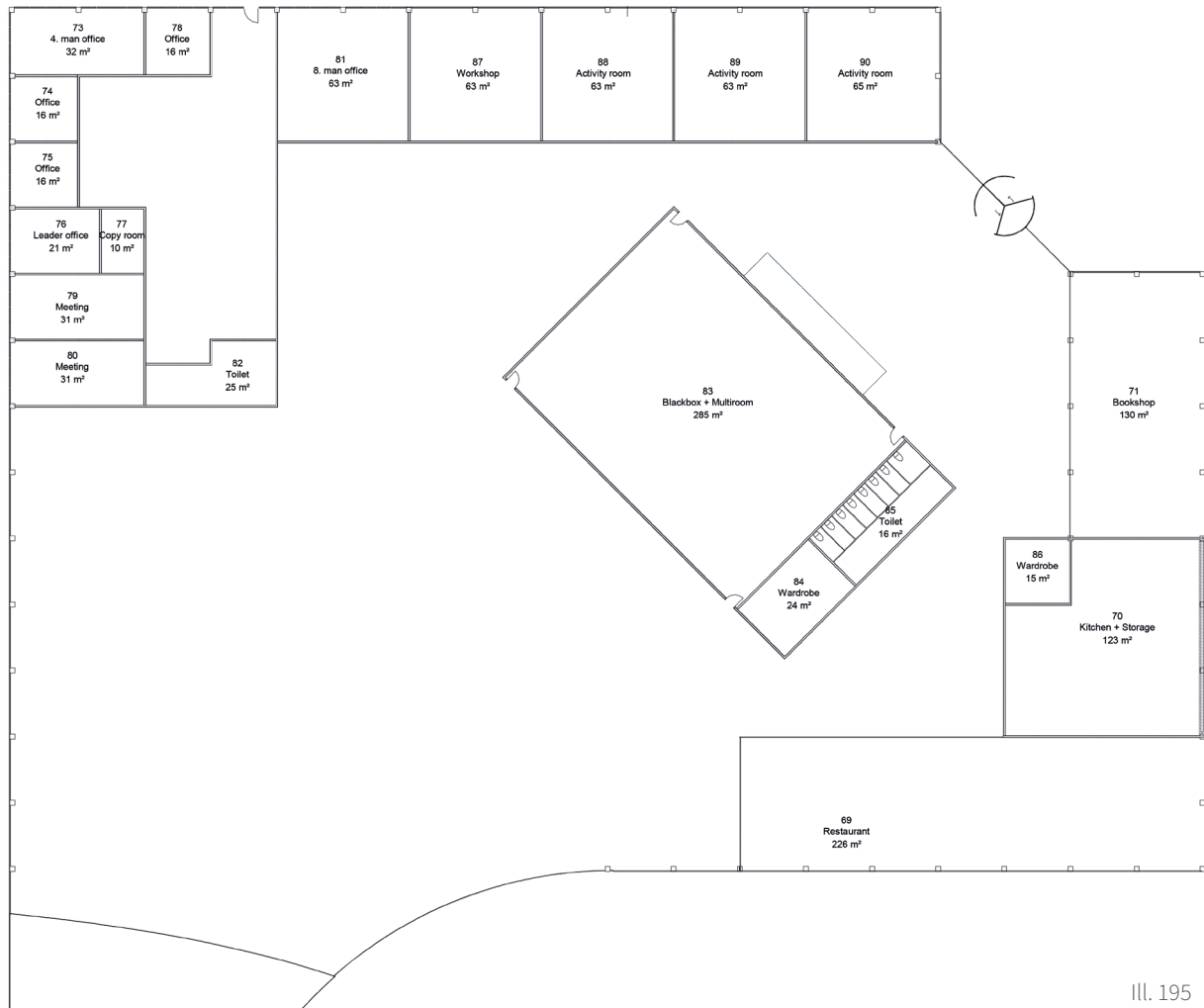

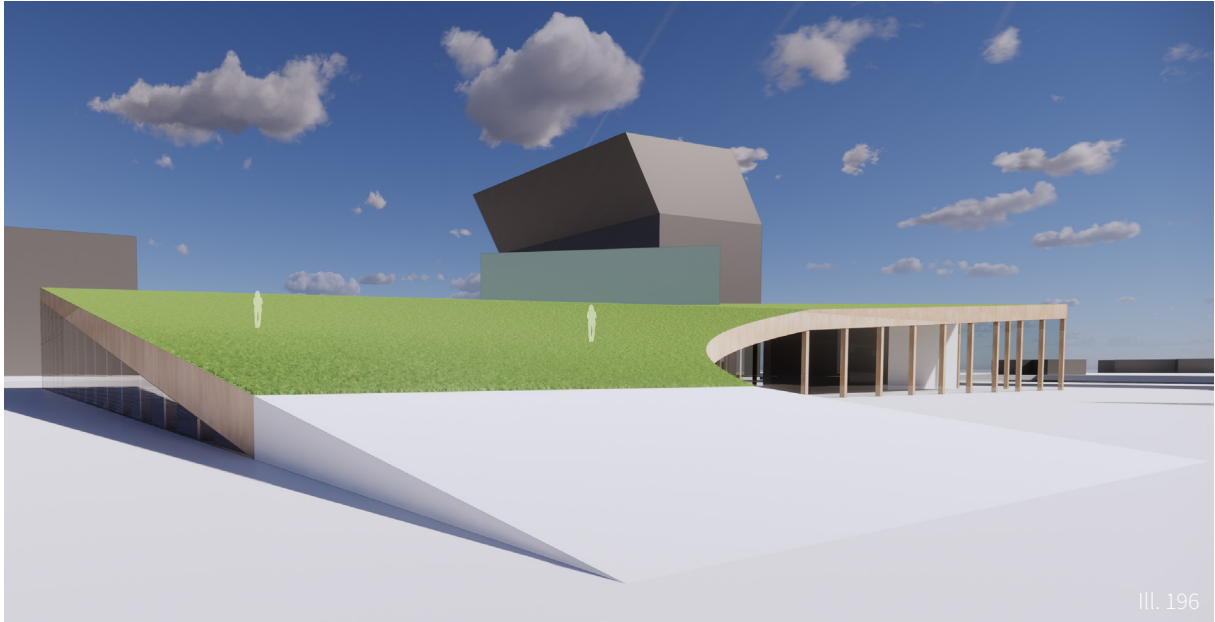

III. 196

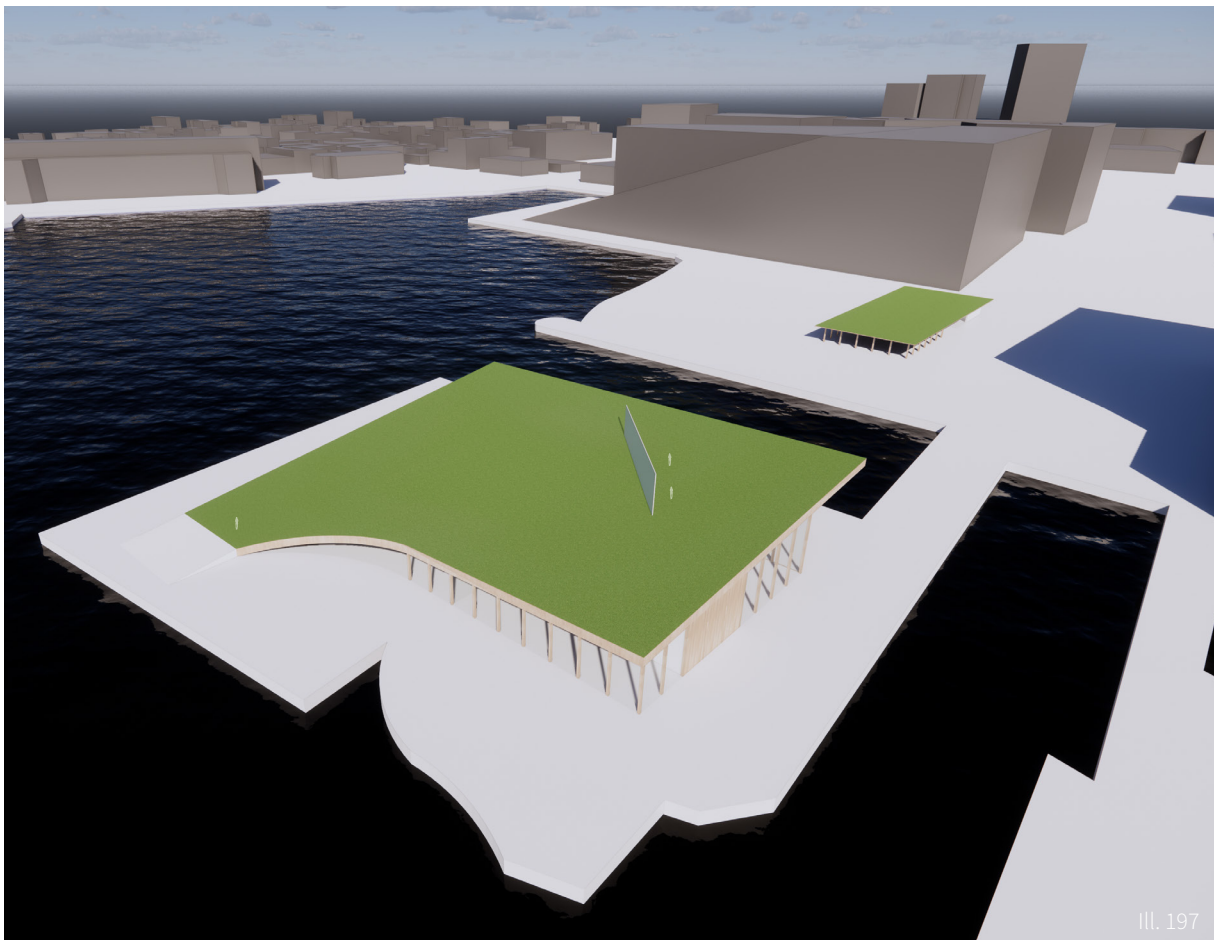

III. 197

THE THIRD PROPOSAL

3.3 PHASE 3

The final proposal in phase 3 induced a more clear line between activity and contemplation, with the adjustment of the multiroom that now no longer at is an angle. In this proposal the activity rooms have been placed towards the eastern facade. The exhibition area would surround the multiroom on three sides, thus creating different exhibition potentials in towards north, west, and south. The side towards north is high to the ceiling with a lot of exposure to the outside while the western and southern being lower and more intimate with a higher degree of control of lighting and ambiance. The roofscape has

been changed from being solely a ramp to have an entry point of stairs. This lowered the inclination of the roof and created a more harmonious experience of the internal space. The plan shows that the eastern part of the building contains many functions that are deemed as activity-based, and constructed in such a way, that a single curtain could be pulled to separate the exhibition from the remaining of the building during evening and out-of-business hours. However, the office space seemed irredeemably placed and disturbed the balance of activity and contemplation.

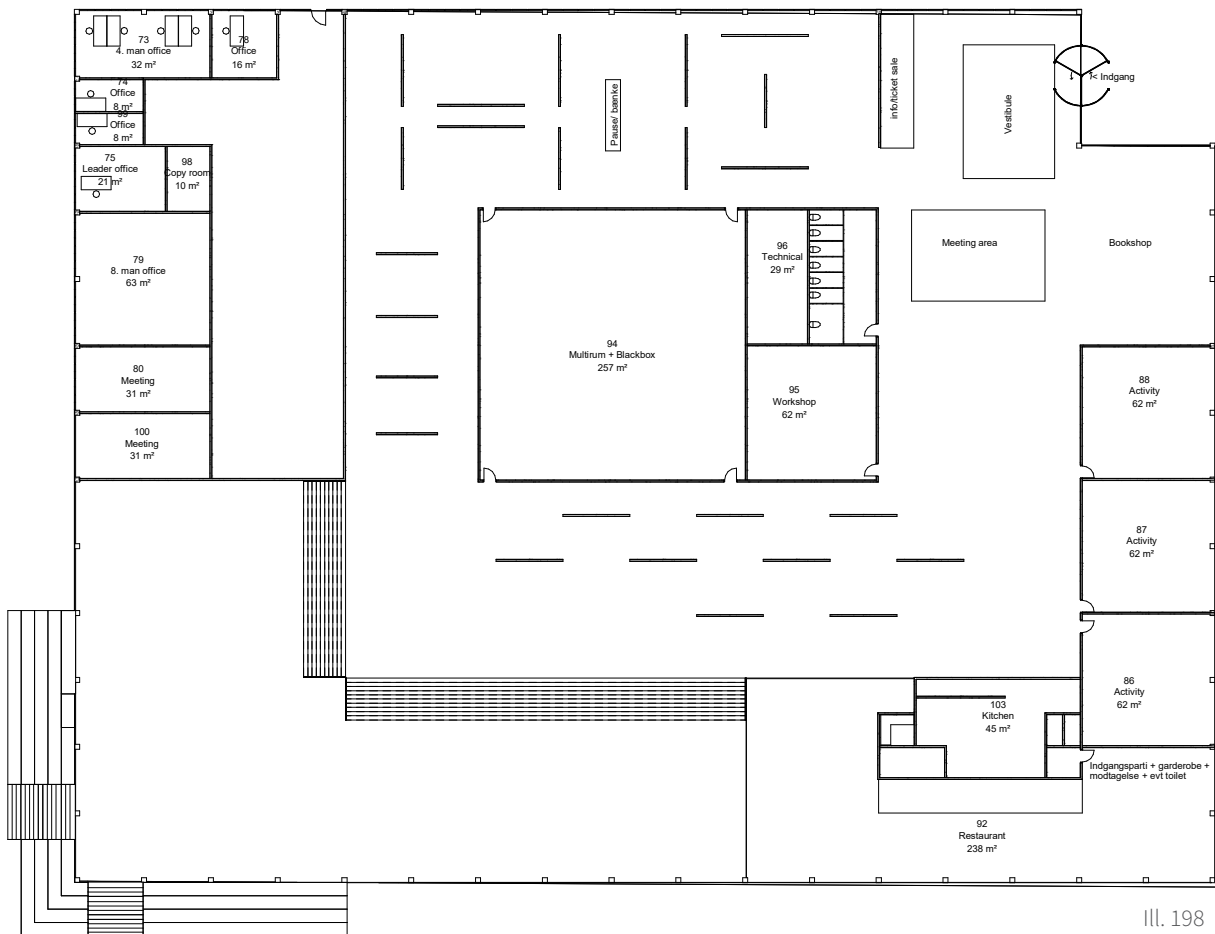

III. 198

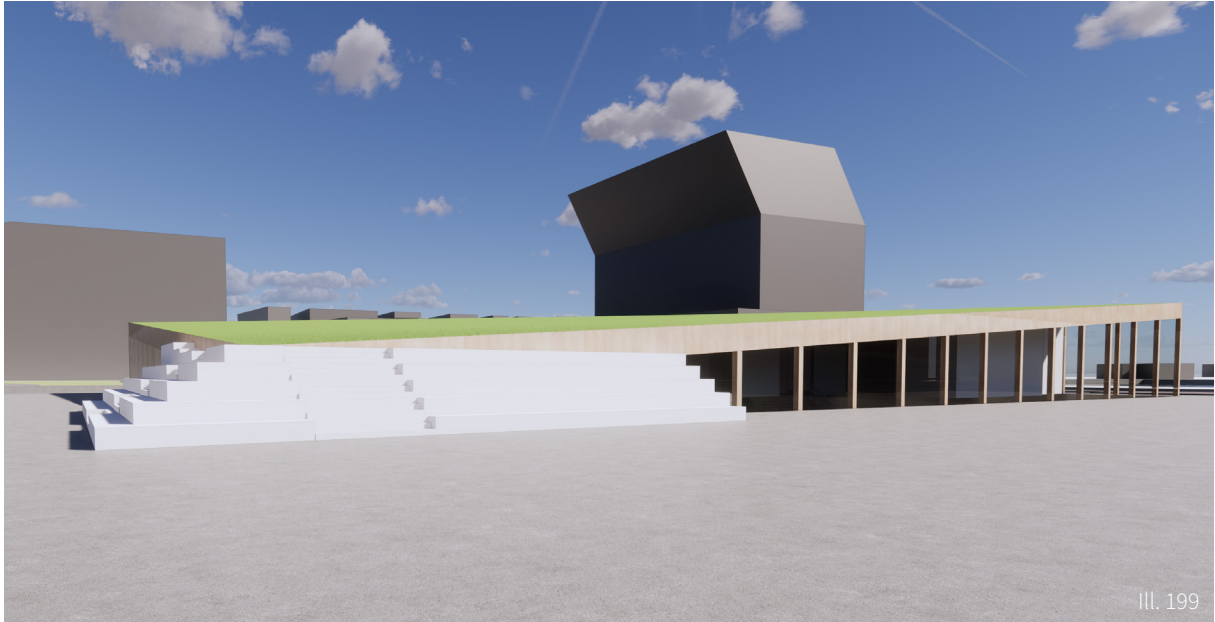

III. 199

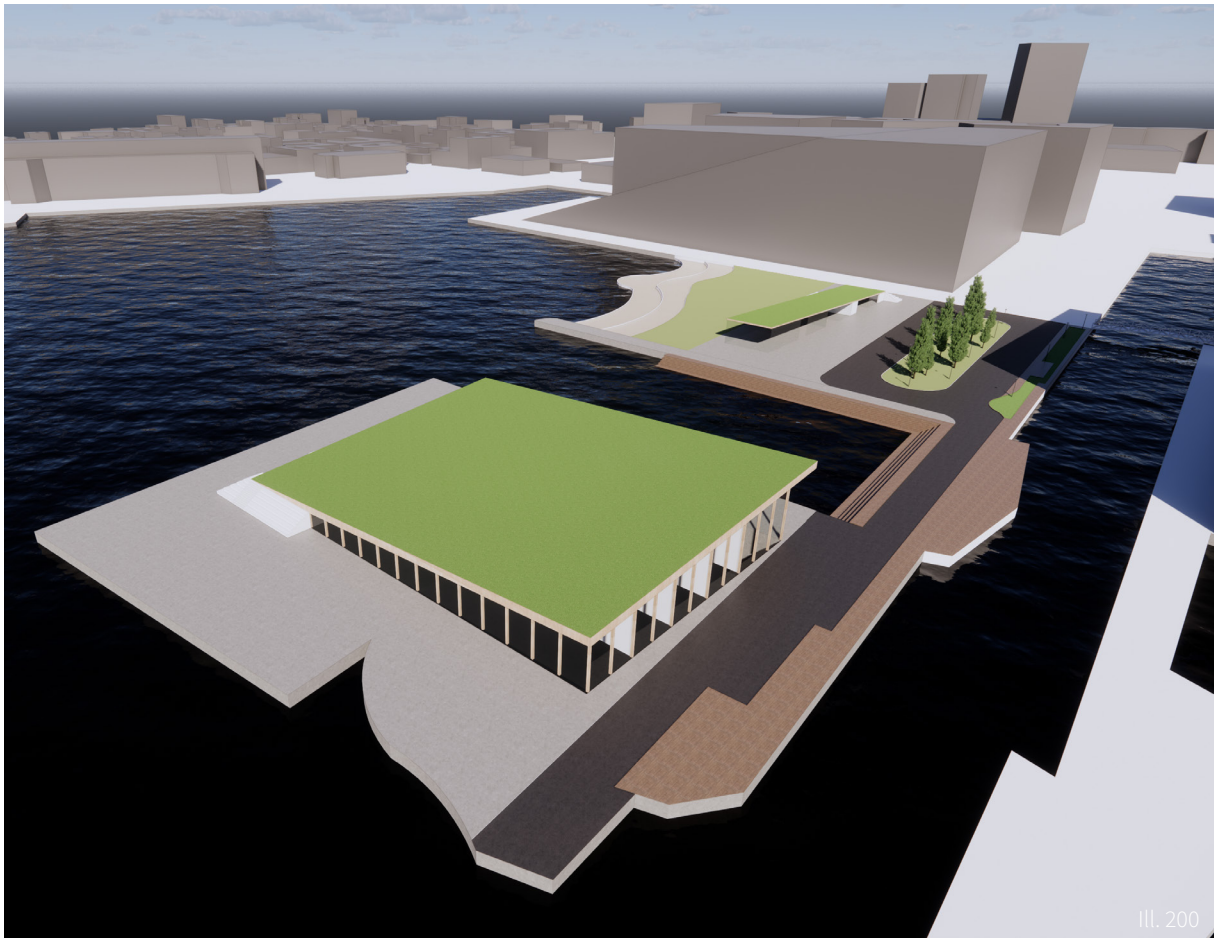

III. 200

SUB-CONCLUSION

4.3 PHASE 3

The take-away potential of the final proposal in phase 3 is the knowledge gained in flexible exhibition potential. The House of Photography could decide to construct an exhibition flow where the user would get the tall and human-scale exhibitions first and navigate toward intimacy and contemplation, or the other way around. Having human-scale exhibitions act as shock effects since the boundary of distance is blurred and it has another kind of impact on the emotional recipient (Lytzen, 2021). Furthermore, the process gave the knowledge of how to create a separation of contemplation and activity that brings

quality to the user experience, and could activate the multiroom in another way, thus making it an active part of the exhibition area with flexible wall elements. The tall exhibition exposed to the northern facade also becomes a point of interest for the surrounding area as almost mimicking an electronic screen in the facade. The exhibitions in the facade has the purpose of exposing photography to the area, and in a way communicating with the exhibition at A10 that creates an oasis of exposure when seated in the urban dock area between the two sites.

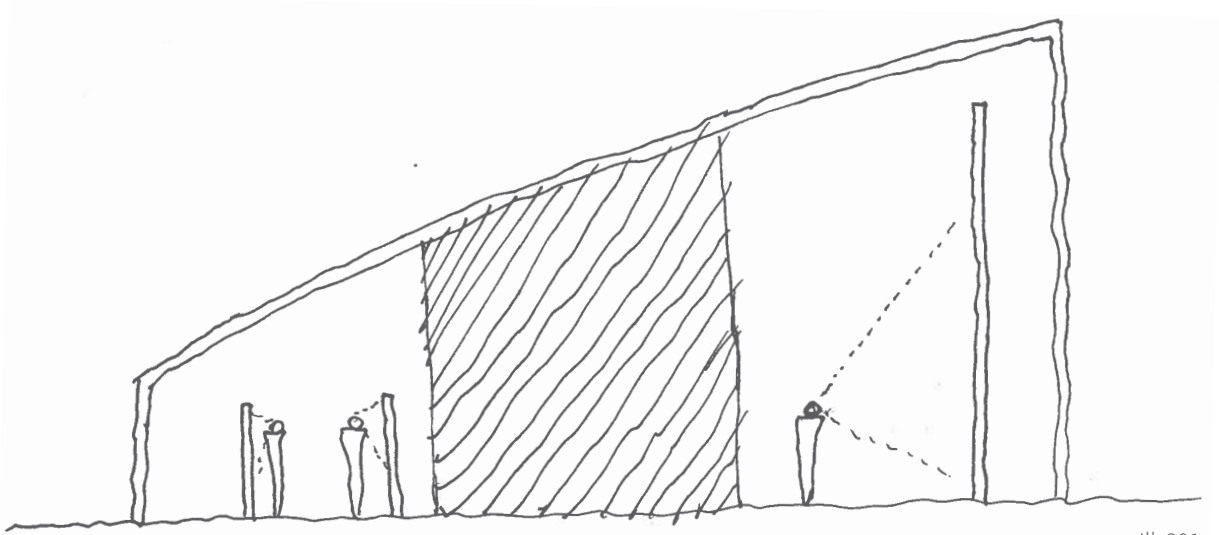

III. 201

A10 DETAILING

3.4 PHASE 4

The initial purpose of phase 4 was to create a visible relation between the building at A11, and the building at A10. This was to be done through the visual connection generated by imitating that the roof geometry was cut from a singular whole. The first concept generated in this phase was a further development of the last proposal from phase 3. The same principle of having stairs in the corner of the building, to lead on to a simple landscape on the roofs would become the backbone of the proposal. However, there was a clear lack of overall form relation between the buildings, and they seemed to be two very independent buildings.



III. 202

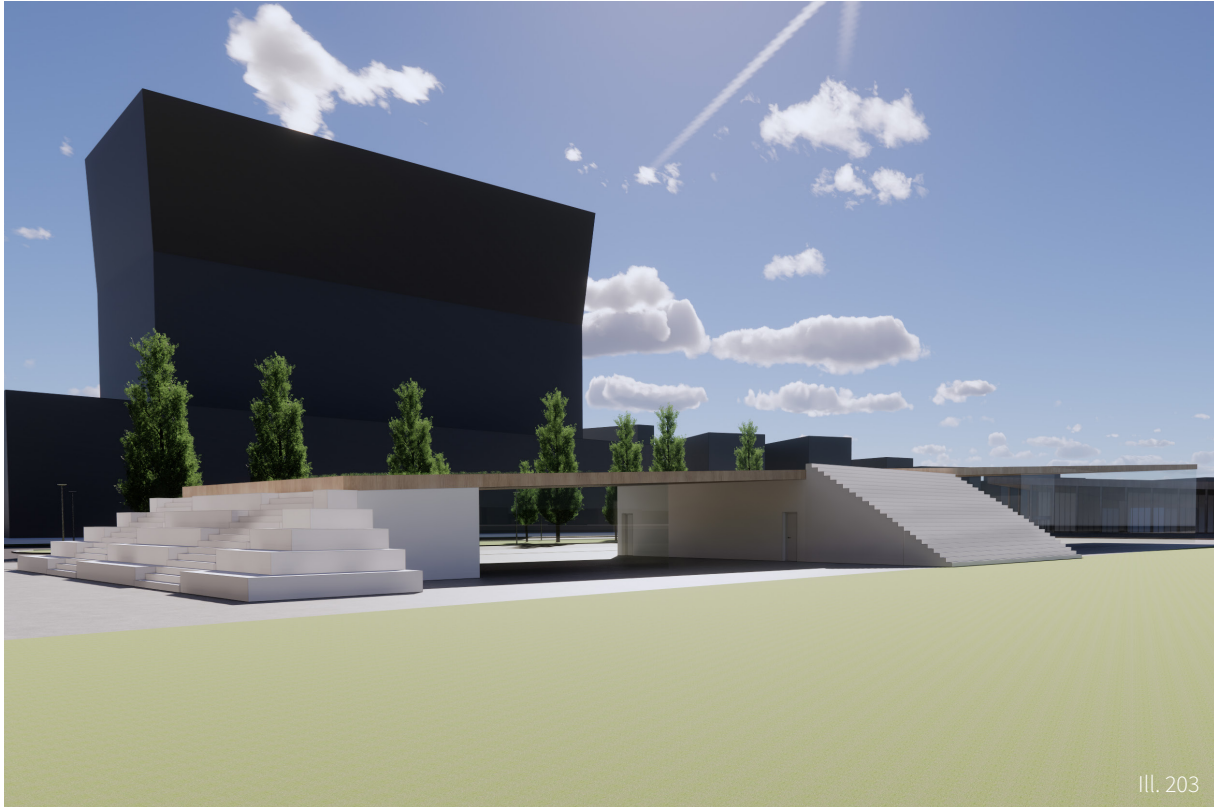

III. 203

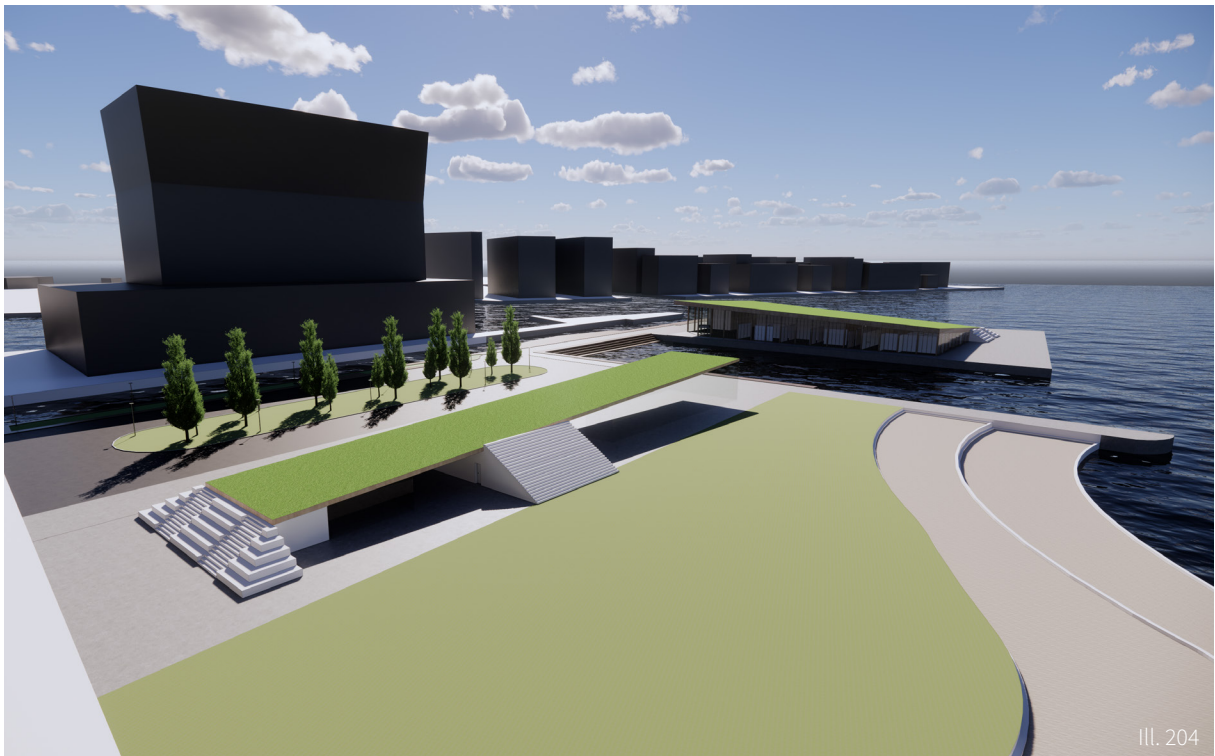

III. 204

URBAN AREAS - A10

3.4 PHASE 4

In cohesion with this proposal, the urban strategy of A10 was developed. The strategy contained planning of park areas, outdoor exhibition, outdoor seating, and outdoor fitness area. The idea of combining these slightly various activities with an open interior exhibition was to allow multiple types of people and generations to meet and possibly engage in relations, which is the core principle of social sustainability.

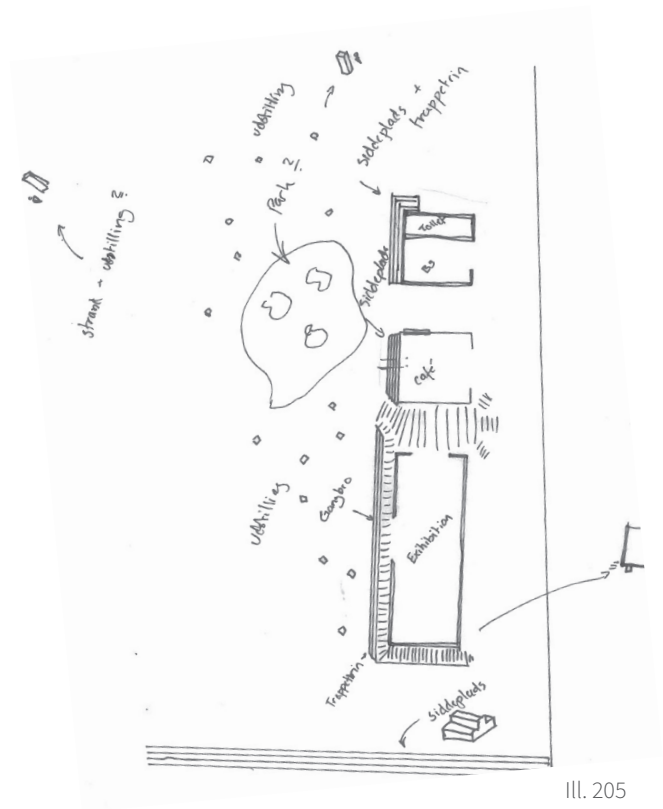

III. 205

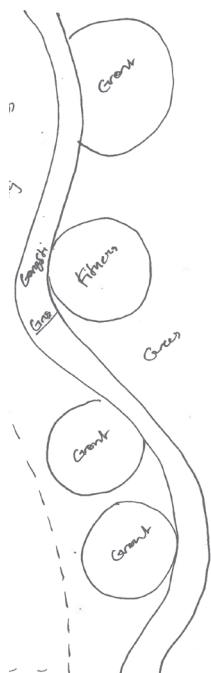

III. 206



III. 207

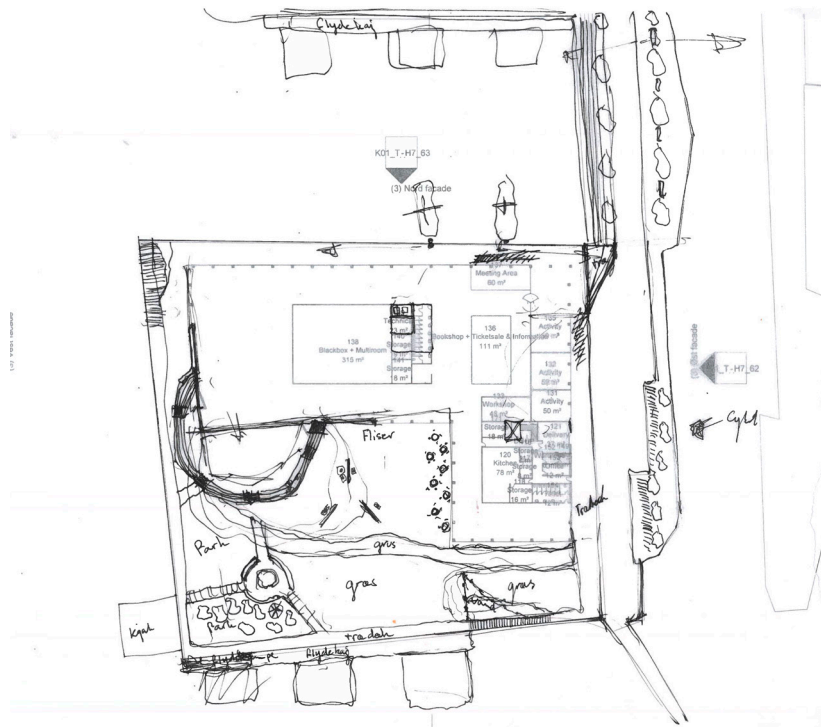

III. 208

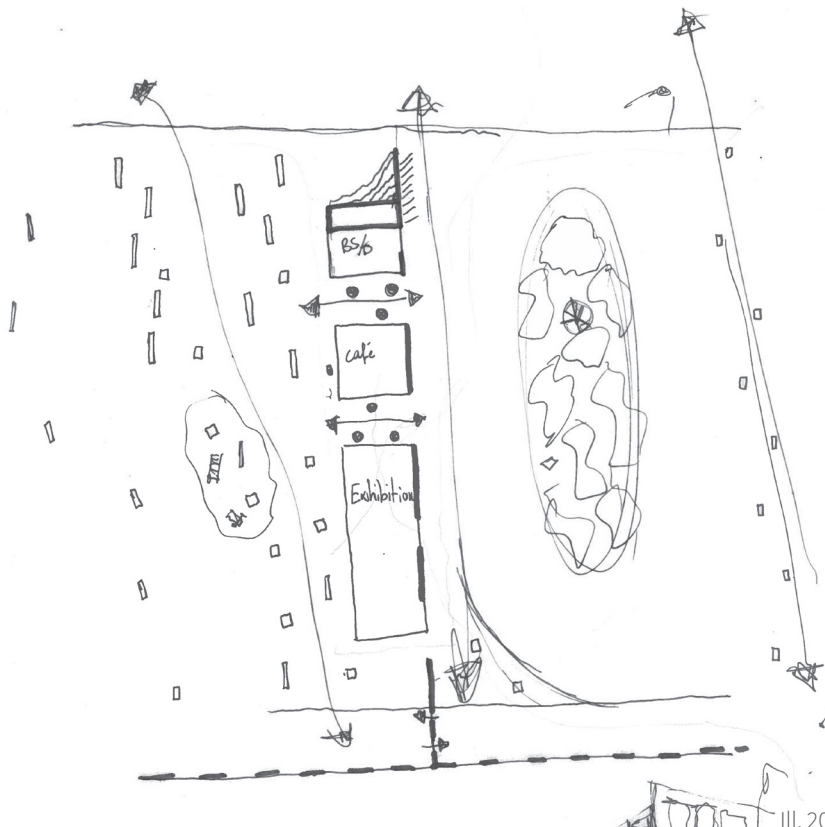

III. 209

ROOF LAYOUT

3.4 PHASE 4

The second proposal had to define a certain connection from the conceptual level. It was visualized, that a slight curvature, forming an arch, could be the founding principle, if this volume was “cut” at two places, thus making the viewer fill in the blank when seeing the buildings in cohesion. The way the metaphoric arch became feasible was through the clear constructive principle that the two buildings would play up against each other. The principle was long continuous beams that would start at ground level, and arch in over the building, becoming extremely visible elements in the interior space and creating an overhang in the orientation of the opposing building. The constructive principle would also free the western and eastern facades from any load-bearing assets, and create an overall dynamic and visible direction

for the two buildings. This will allow the visitors to understand the relation of the buildings through their plays. Having the two opposing facades in A10 and A11 contain large-scale exhibitions would emphasize the character of the space in between them, making it emanate photographic exhibition. However, the large-scale construction spanning in one direction, in cohesion with the interior design of the exhibition on multiple levels under the same roof, created a phenomenological relation to a swimming hall or a sports arena. It was deemed that the interior dynamics would become a focal point rather than the actual exhibitions, thus failing in achieving the primary purpose of this building, which is to facilitate art, rather than becoming the primary art.



III. 210

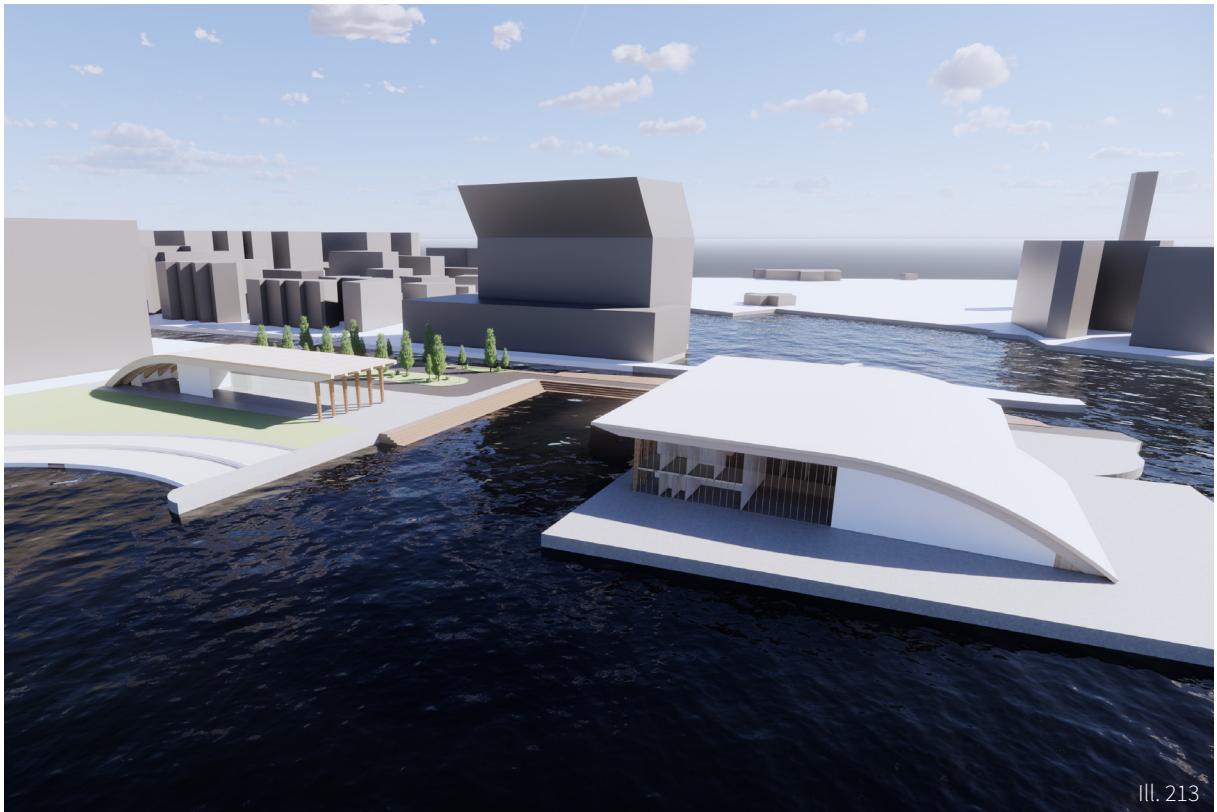
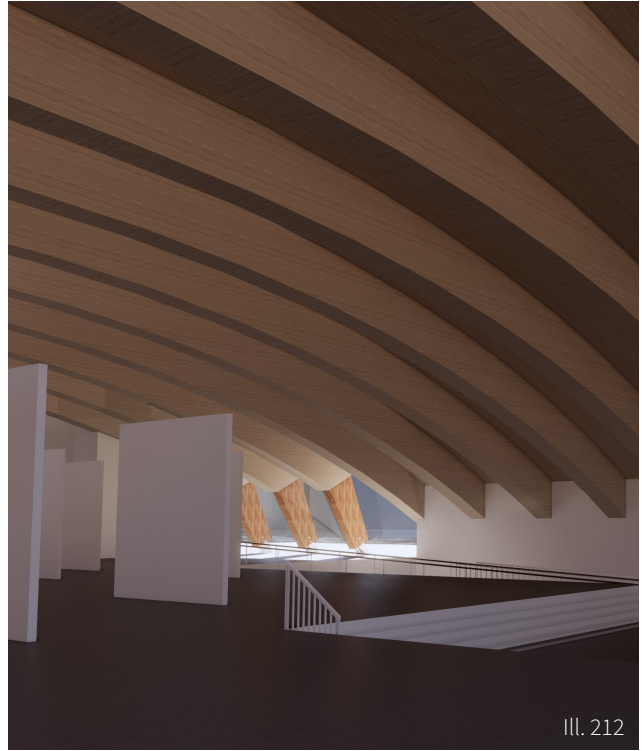

THE THIRD PROPOSAL

3.4 PHASE 4

The second proposal's roof was very inaccessible, and the third proposal attempted to structure a staircase as an accessway once more. This time around, the staircase became double functioned from the planning and contained primary access paths and seating areas. The staircase thus became an integrated bridge between the urban strategies on the ground floor and the urban activities on the roof. The seating areas on the staircase allowed for seating facilities in case an outdoor exhibition or speech would occur on the event plaza enveloped by the building. Creating the balance between moving activities and seating with planned views became fundamental in establishing the roofs. A11 contained a seating area towards the north, allowing for views towards A10 and the opera, and seating towards the east with a view to the Munch museum and Søren-

ga area. A11 contained seating to the west with views to the beach, and seating to the south with views to the exhibition at the primary museum. The integrated seating area in the roof could also alter the interior room height in certain rooms, where the room height didn't have a need of being 8 meters, such as the activity rooms under the eastern seating area on A11. The plan was structured slightly differently in this third proposal as opposed to the second proposal, with the offices moved from the northwestern corner to an elevated position above the restaurant at the extruded southeastern corner. This created the harmonious separation of activity and contemplation sought after in phase 3, with the information, bookshop, and meeting area being the facilitating middle space guiding visitors in the sought direction.

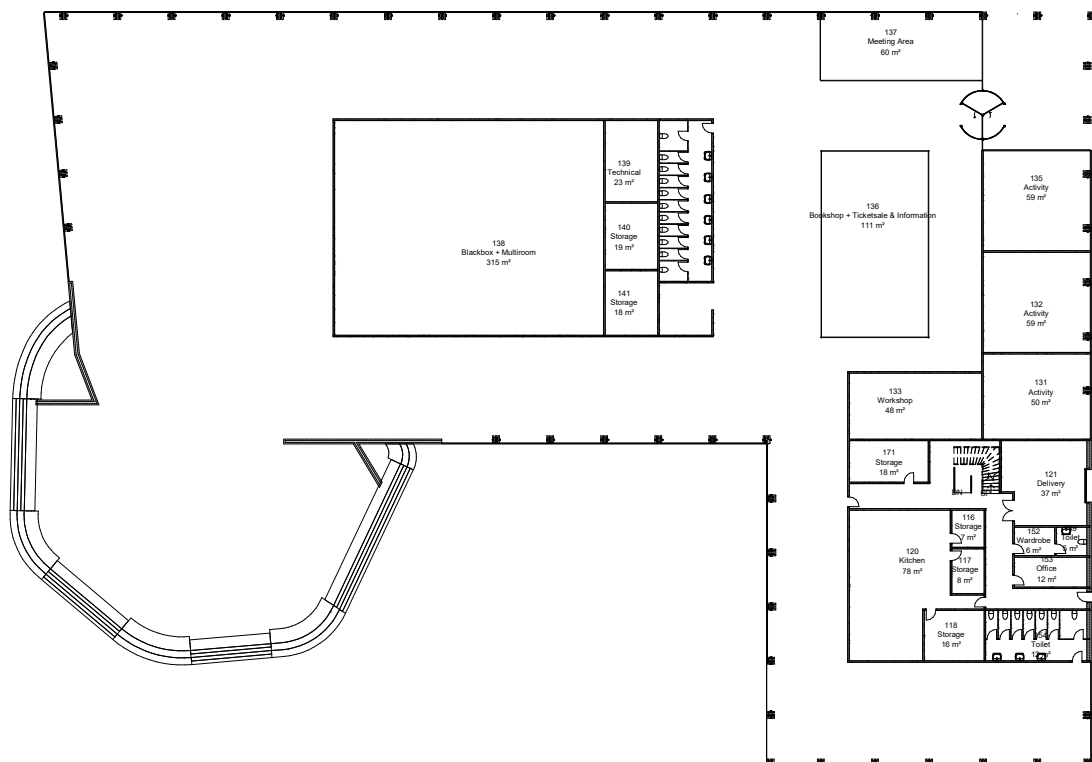

III. 214

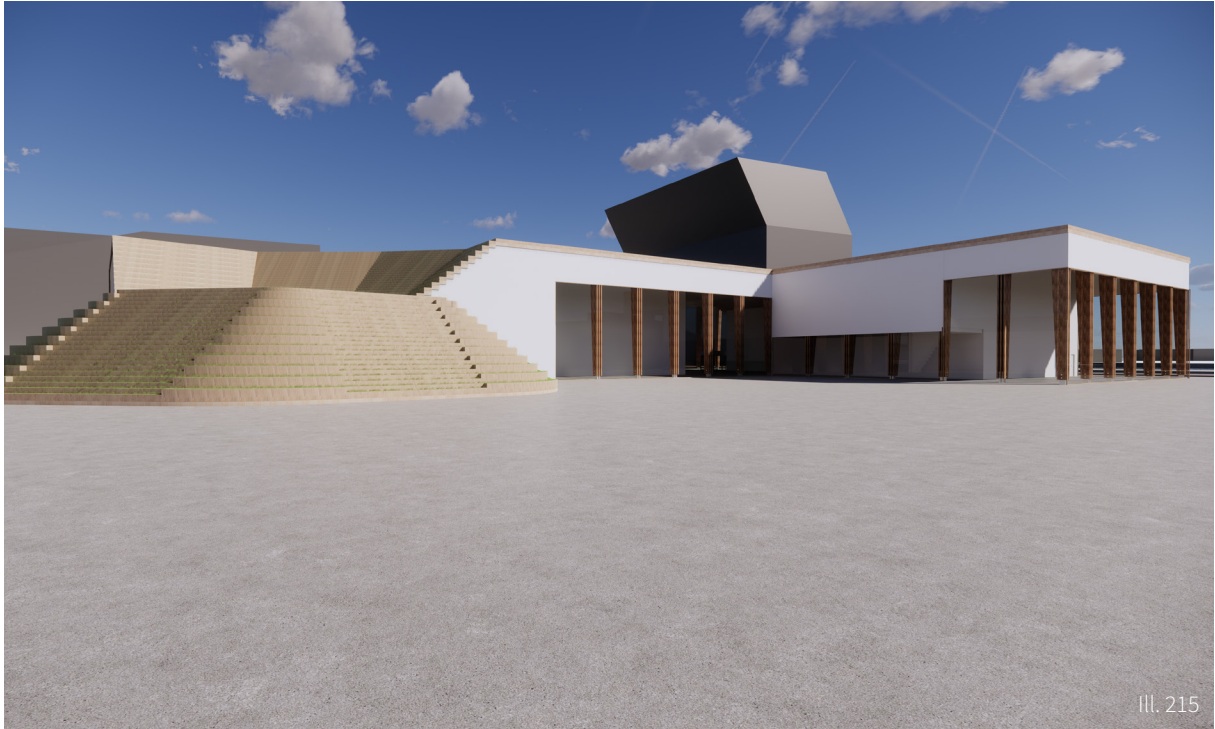

III. 215

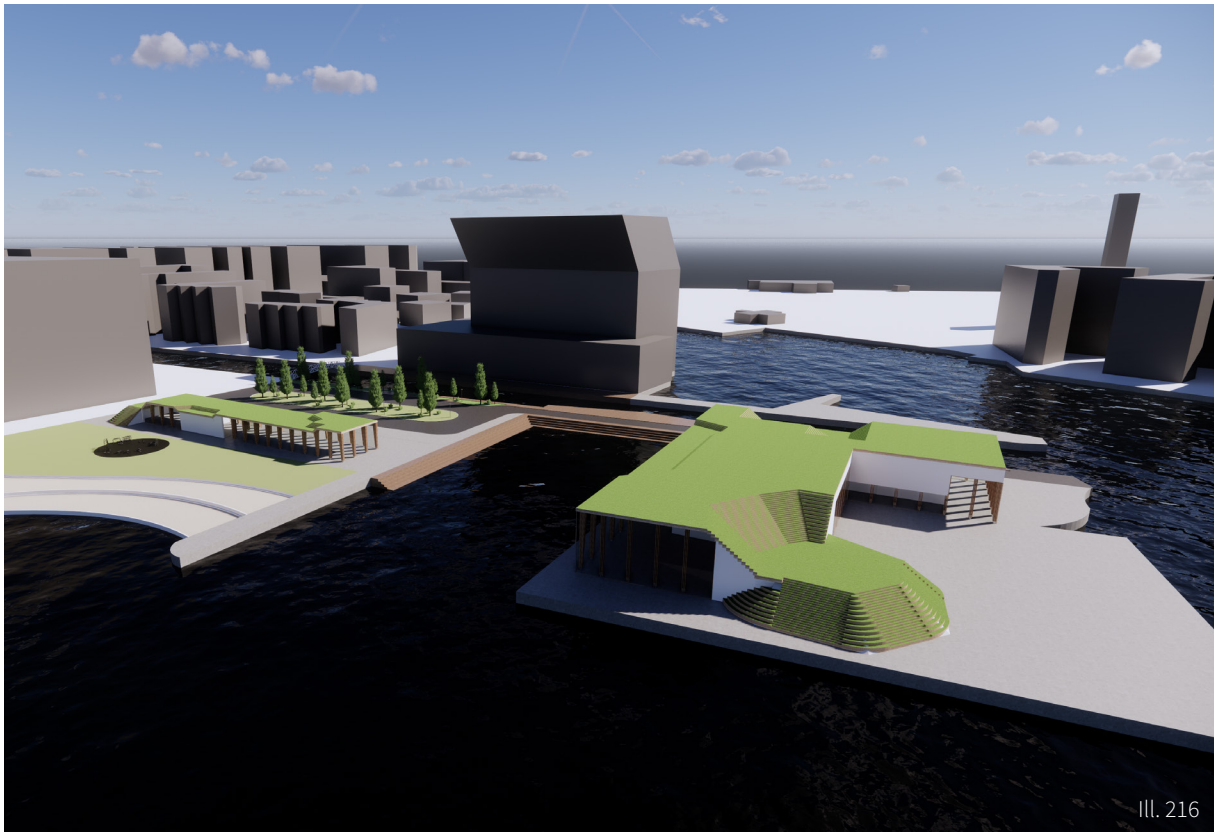

III. 216

DAYLIGHT ANALYSIS

3.4 PHASE 4

With the new placement of the offices, daylight analyses were made in order of investigating DGNB SOC 1.4 of visual comfort. The office spaces were created with views of the surrounding area and high-quality daylight was sought. Furthermore, various window openings influence the daylight and indoor climate in terms of operative temperatures and over temperatures. The comfort ventilation is calculated for each room and is undefined by the window openings size, and the operative temperature shifts slightly during the variations. The maximum temperature is the factor influenced the most by the varieties in window openings, and to combat the over temperatures, a user-controlled external solar shading will be implemented, which also relates itself to DGNB SOC 1.4.2.

As can be seen in proposal 2, 4, 5 and 6 of the leader's office, the maximum temperature becomes much higher than the 26 degrees that the Danish Working Environment Authority recommends. The maximum temperatures are based on comfort ventilation, and if the overtemperature had to be eliminated by excessive ventilation, the airflow would have to change from 1.05 l/sm² to 12.75 l/sm² which could lead to draft and noise pollution. The implementation of user-controlled external solar shading would lower the maximum temperature from 36.97 degrees to 27.49 degrees, so only a slight increase in the ventilation rate to 1.8 l/sm² would eliminate the remaining over temperatures (see appendix 5).

Comfort ventilation	Single office	Leader office	4-person office	8-person office	Meeting room
Flow of air	0.102 m ³ /s	0.014 m ³ /s	0.021 m ³ /s	0.078 m ³ /s	0.05 m ³ /s

III. 217

Maximum temperature	Single office	Leader office	4-person office	8-person office	Meeting room
Proposal 1	30.22 °C	34.51 °C	25.85 °C	25.81 °C	25.37 °C
Proposal 2	31.13 °C	36.97 °C	26.60 °C	26.55 °C	25.97 °C
Proposal 3	31.13 °C	35.51 °C	28.79 °C	26.55 °C	25.61 °C
Proposal 4	31.13 °C	36.97 °C	28.79 °C	27.28 °C	25.97 °C
Proposal 5	32.45 °C	36.97 °C	27.35 °C	27.28 °C	25.97 °C
Proposal 6	29.29 °C	36.97 °C	27.35 °C	27.28 °C	25.97 °C

III. 218

Daylight factor

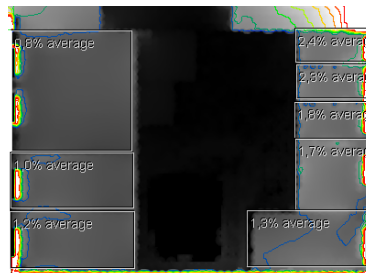

Proposal 1

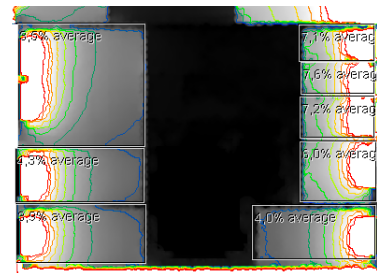

Proposal 2

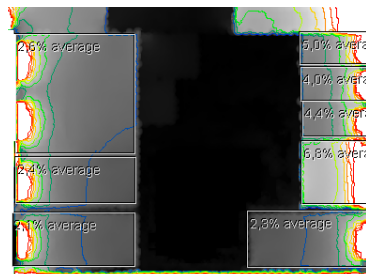

Proposal 3

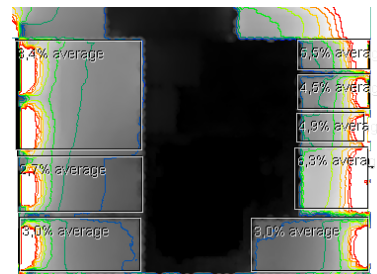

Proposal 4

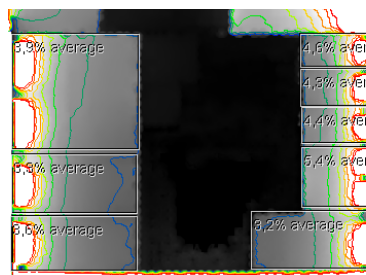

Proposal 5

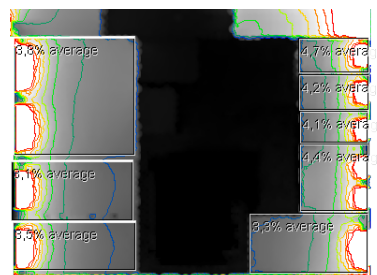

Proposal 6

Ill. 219

Operative temperature	Single office	Leader office	4-person office	8-person office	Meeting room
Proposal 1	22.55 °C	22.67 °C	22.15 °C	22.34 °C	22.17 °C
Proposal 2	22.65 °C	22.89 °C	22.14 °C	22.33 °C	22.25 °C
Proposal 3	22.65 °C	22.81 °C	22.30 °C	22.33 °C	22.16 °C
Proposal 4	22.65 °C	22.89 °C	22.30 °C	22.31 °C	22.25 °C
Proposal 5	22.61 °C	22.89 °C	22.32 °C	22.31 °C	22.25 °C
Proposal 6	22.47 °C	22.89 °C	22.32 °C	22.31 °C	22.25 °C

Ill. 220

SUB-CONCLUSION

3.4 PHASE 4

The third proposal of the fourth design phase showed the highest degree of potential in terms of establishing the harmonious relation between contemplation and activity, while also establishing a functional user flow with direct pathways to the desired destination. The constructive system adds a dynamic presence within the building, which still points inwards. The potential of the activation of the roof as urban space is high and can influence the development of the outdoor urban areas to a large degree. The backstage of the restaurant was redesigned, and now has the delivery of material on the ground floor with direct access to the basement storage facilities. However, the building at A10 does not relate itself enough to the building at A11. The building at A10 is long and narrow and takes away from the idea of having the buildings being cut from the same block or at least form a somewhat symmetrical geometry. The design process requires the fifth phase to allow these buildings to have the connection they desire.

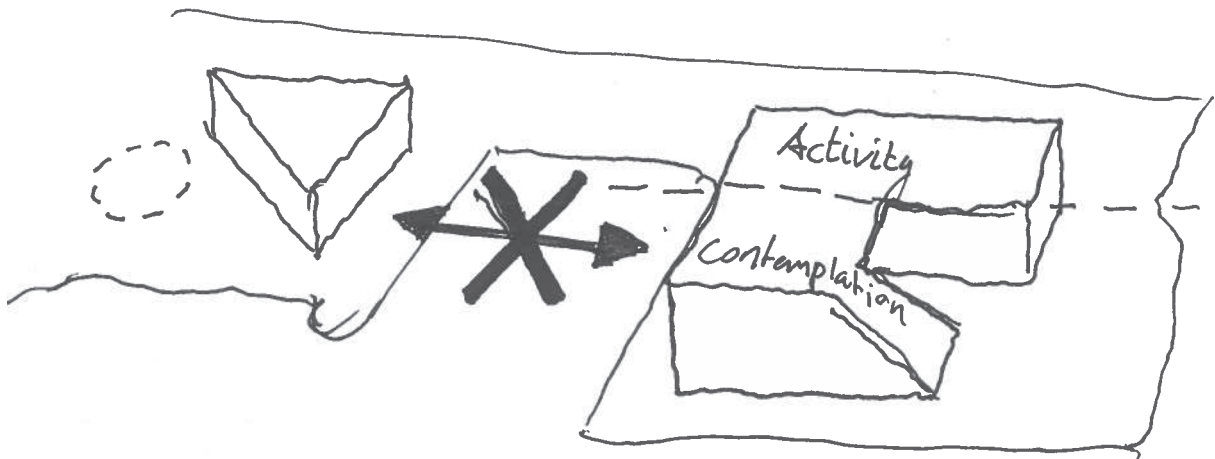

III. 221

BUILDING LAYOUT - A10

3.5 PHASE 5

To establish a more cohesive relation between the two building sites, the building at A10 transformed from a singular narrow building into two separate buildings. The building volumes encompass a plaza in between, thought to host exhibitions and mimic the ambience of the amphitheater enveloping the event plaza at A11. The internal functions of the two volumes determine their placement, with the southernmost volume hosting exhibition facilities, standing in clear communication with the exhibition area at A11. These two open facades envelop the urban water area in an atmosphere of photographic exposure. The northernmost building volume contains the beach service area, the wardrobes, and the café. These functions are outgoing and oriented towards the people arriving from the city through any of the access roads.

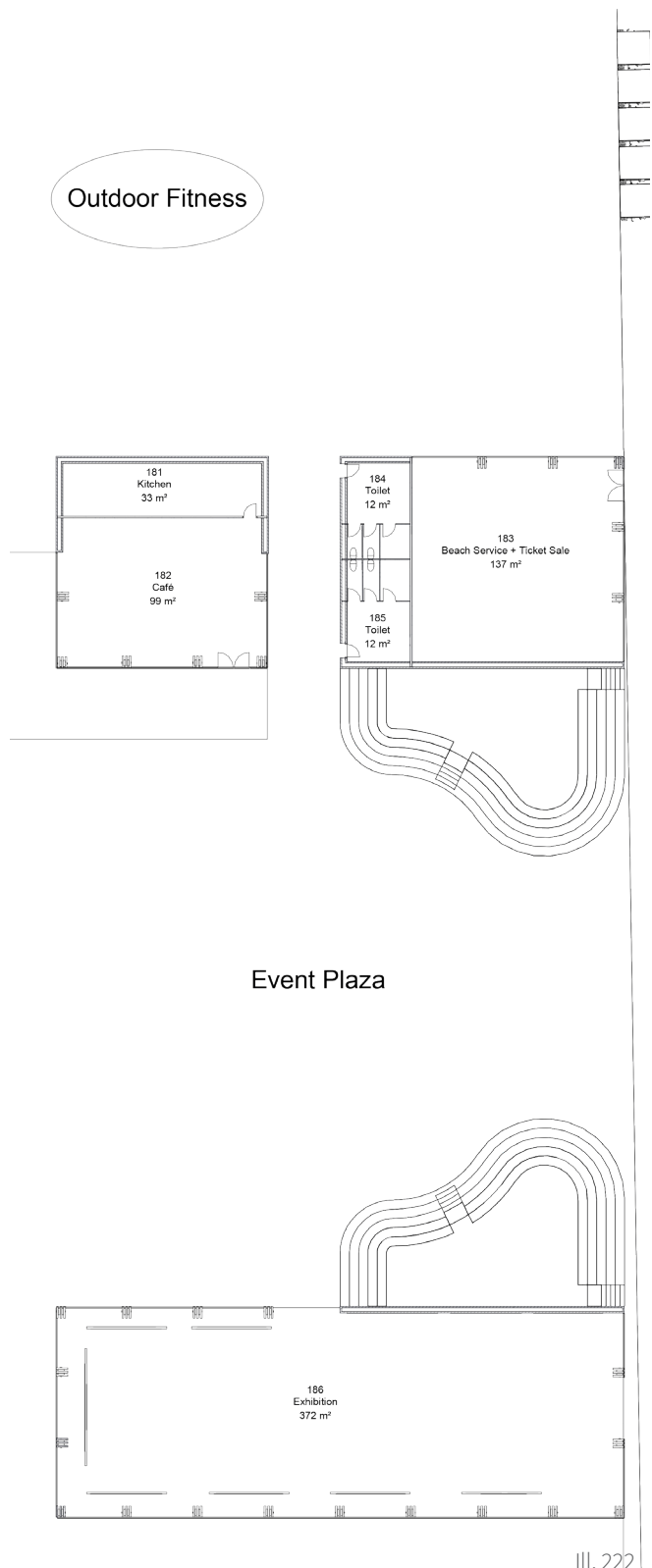

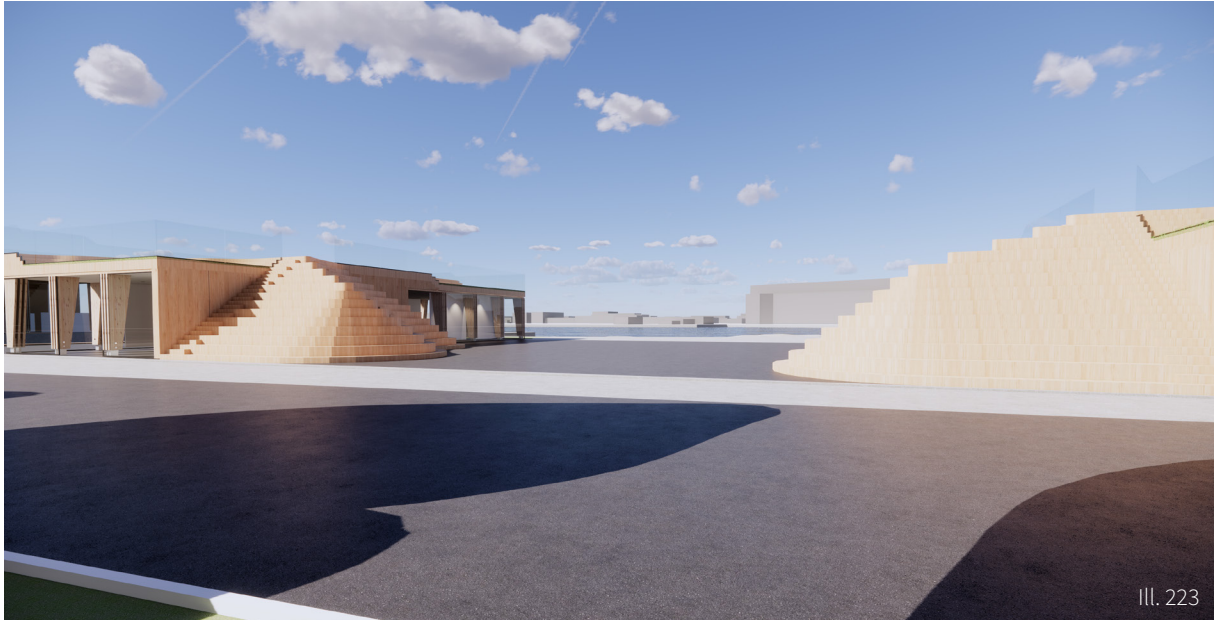

III. 223

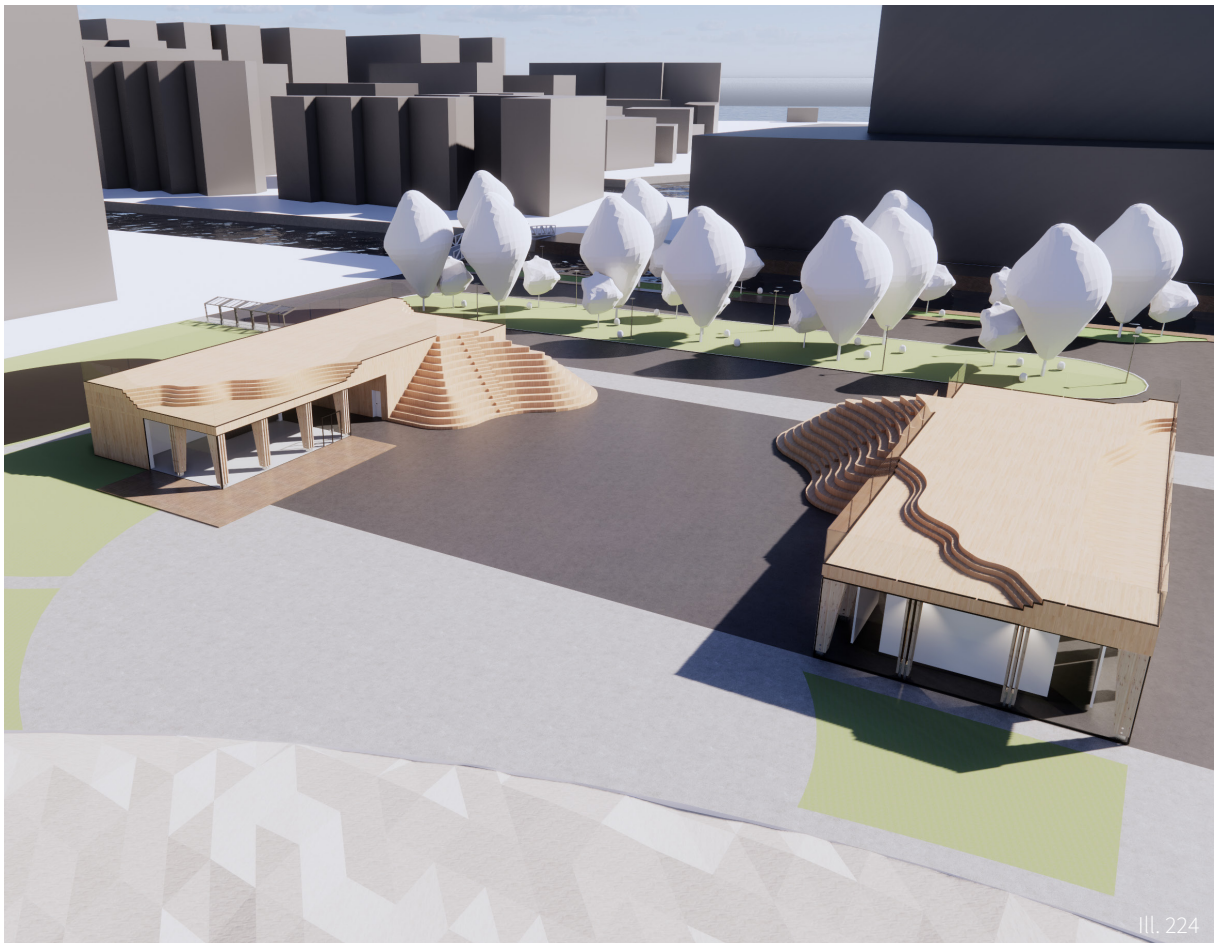

III. 224

URBAN AREAS - A10

3.5 PHASE 5

The urban development at the A10 site can be separated into two developments, the ground based and the roof based. Fundamentally they serve two independent functions. The ground based urban development serves the purpose of allowing people of various backgrounds and groups to meet in informal places and activities thereby empowering the notion of social sustainability. These informal activities include places such as outdoor recreational park areas, outdoor fitness areas, and informal outdoor exhibitions. The exhibition is supposed to allow the purveyors

to comment on social issues and thereby also introducing art at eye level as something that everyone can have an opinion on. Aside from the developed urban areas in this project the municipality plans on developing a beach in close proximity thereby also including additional visitor groups. The two volumes on A10 have two staircases that lead people from the ground floor up to the top of the rooftops. The staircases have been designed as a variety of amphitheater scenes that envelop the outdoor exhibition between the buildings.

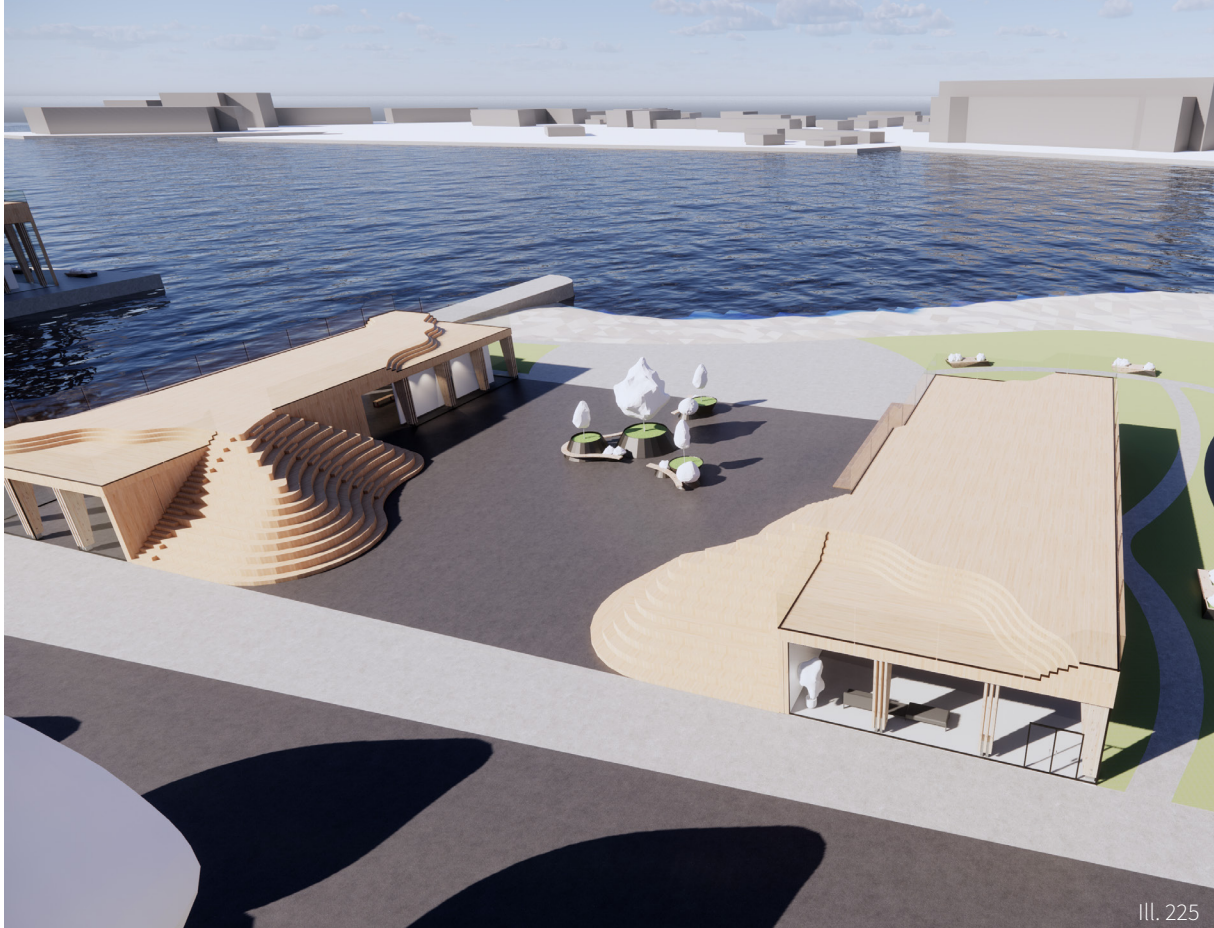

III. 225

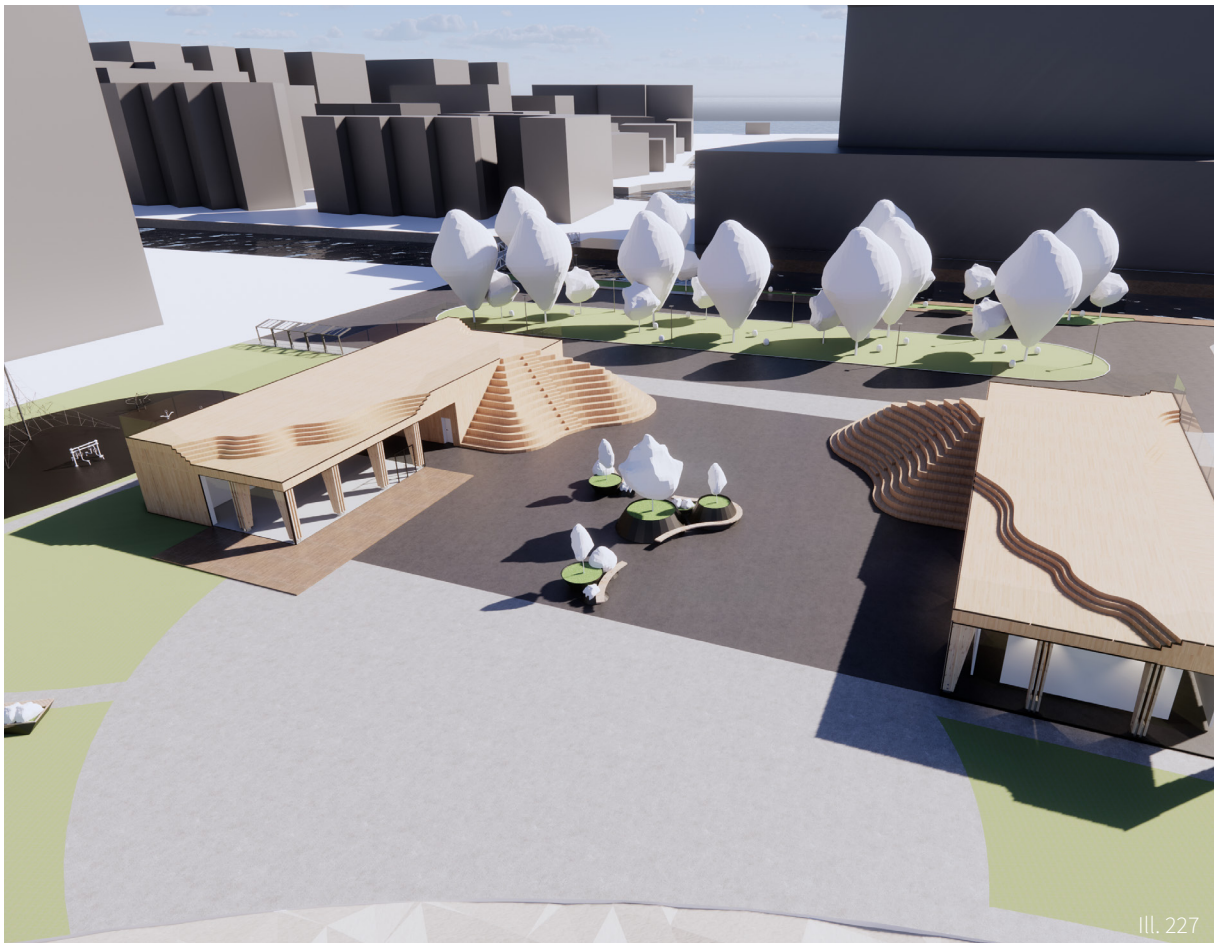
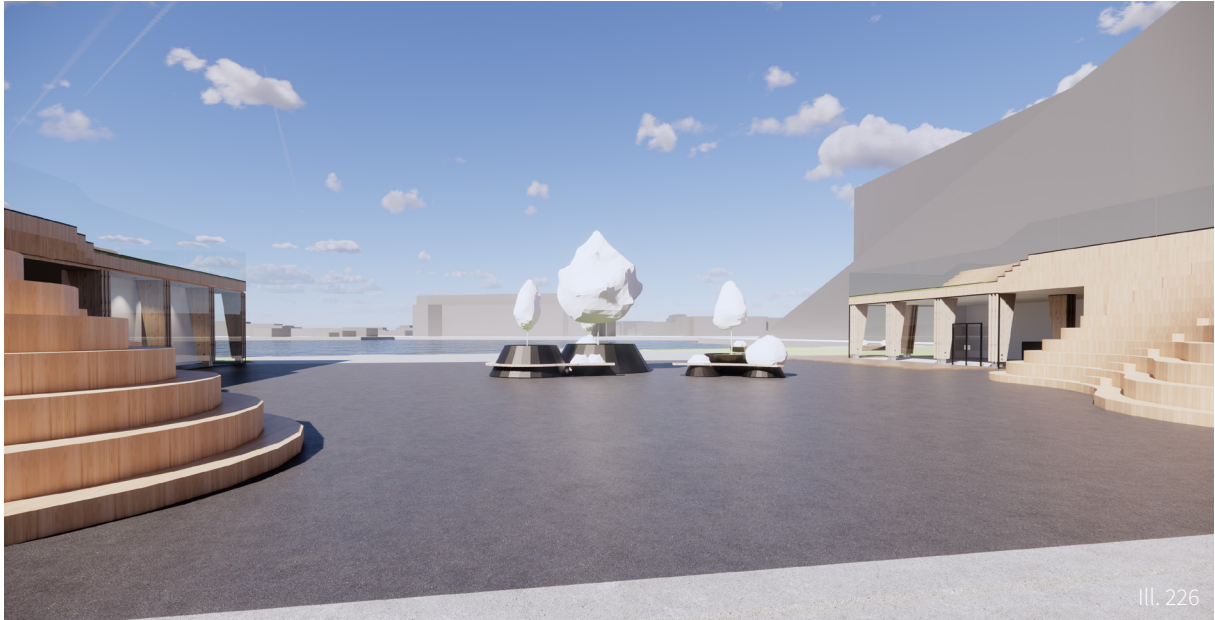

ROOF LAYOUT

3.5 PHASE 5

The urban developments on the roofscapes aim to contrast the hard surfaces on the site and context. The roofscapes are designed as staircases with integrated seating, and while on top of the roofs, the possibility of descending into green areas in connection with seating is present. The purpose of introducing greenery and small activities such as trampolines on the roofscapes is to avoid the notion of the roof

being an empty experience rather than actually being considered as an urban development. The planar surfaces of the roof also enable the continuation of the outdoor or exhibition is an active asset in the strategy of urban development thereby also enforcing the character of the museum and allowing it to spread from the interior of the building and leave its mark on the outdoor areas.

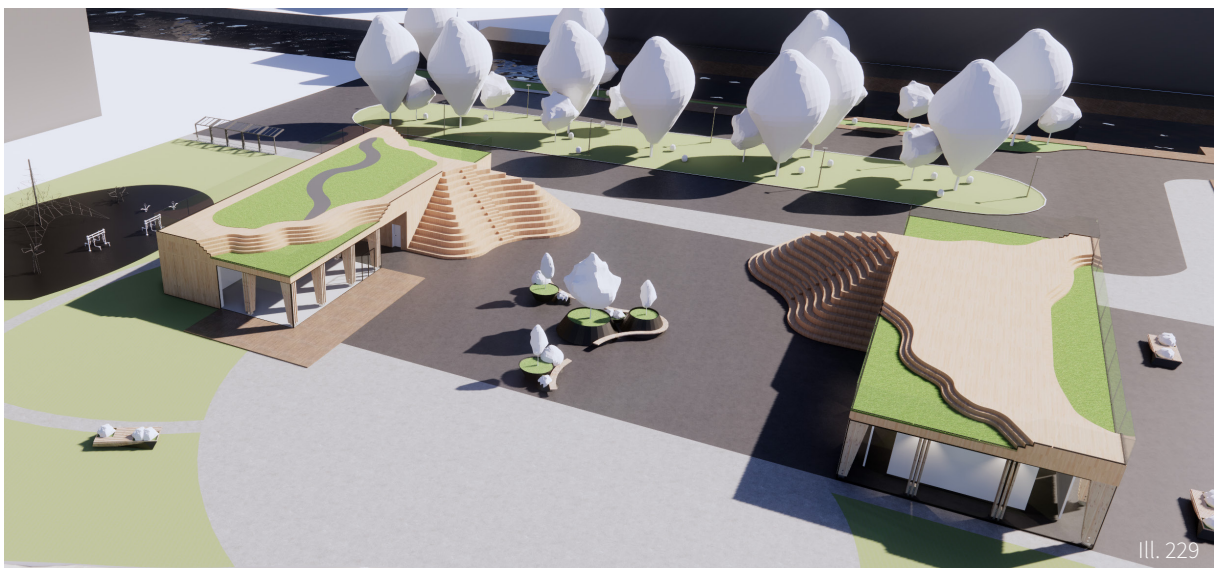
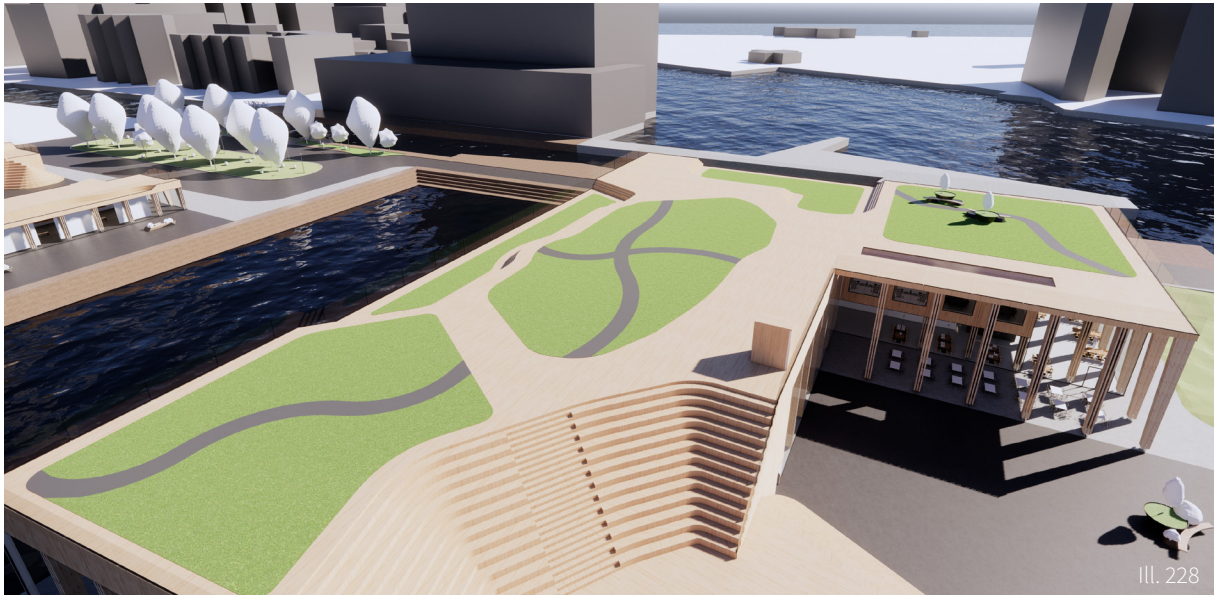

URBAN AREAS - A11

3.5 PHASE 5

The urban development on A11 reflects the idea of largely maintaining the current ground material of concrete. At the event plaza in between the staircase leading to the roof, and the restaurant, there will be outdoor seating for the restaurant as well as occasional outdoor exhibition or speeches. South of the event plaza, social furniture with benches and organized greenery create informal gathering places. The southeastern section of the site will introduce a grass area that slopes towards the fjord. Along the periphery south and east of the site, wooden paths will be established, creating a sloped accessway to the docks on the fjord. The docks will contain the possibilities of bathing and relaxing in the sun. The wooden path floats on top of the water at the grassy area, encompassing a small lake. The bridge from Sørenga connects to the developed wooden path and combines the accessways into integrated parts of the urban development. The westernmost part of the site presents a dock established for the local kayak club and provides an opportunity

for hoisting and lowering kayaks along the side of the dock. The seating area on the staircases leading to the roof are organized so that a view is granted to various urban activities. Along the easternmost wooden path is also a covered bicycle parking, providing a short distance to the primary entrance, or the stand-alone entrance to the restaurant.

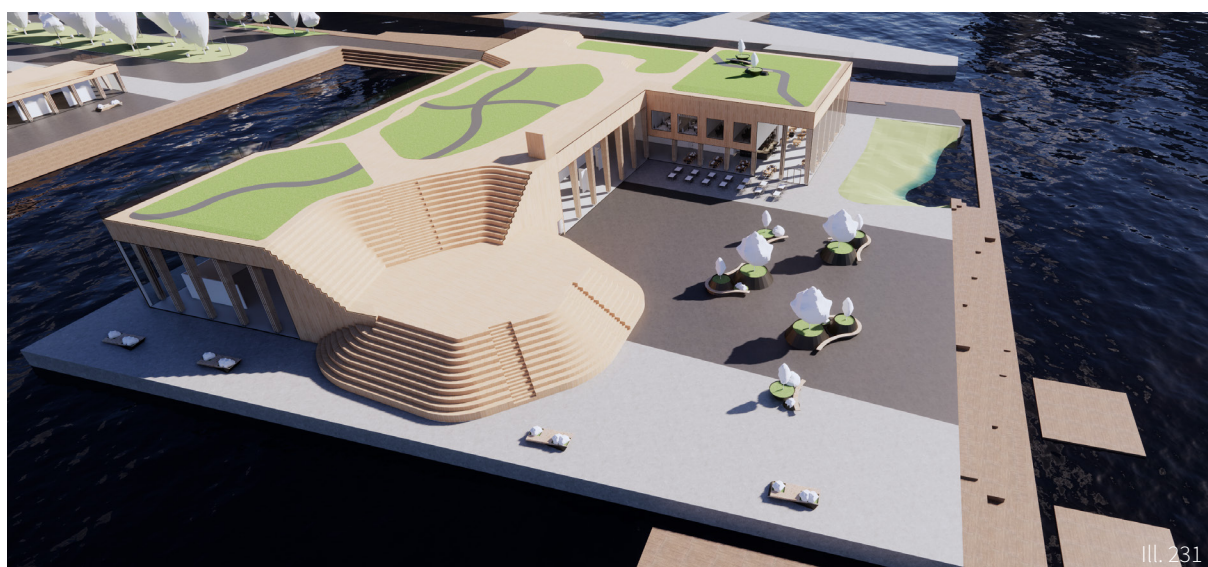
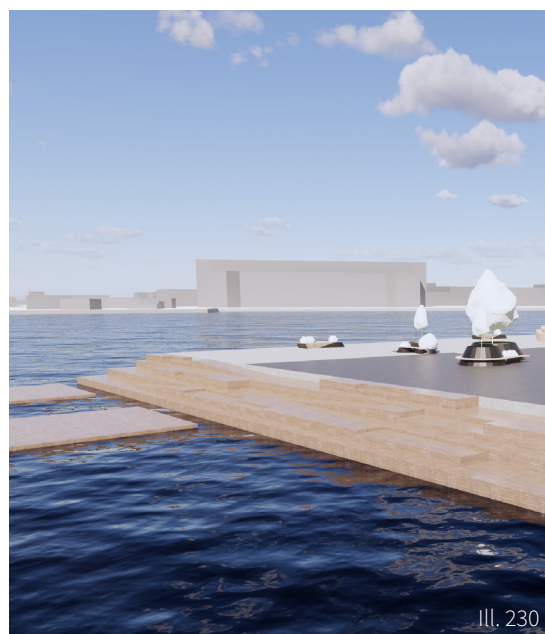

FACADE DETAILING

3.5 PHASE 5

The envelopes are built with a facade cladding of Cedar veneer in modular elements. This means that the windows in the office spaces had to be shifted slightly to fit into the modular discs. Also, a new daylight analysis has been made to ensure the daylight factor would not be reduced in quality. It is estimated that by not altering the size of the openings, and only shifting them slightly in the plan, it is not required to perform new operational- or maximum temperature calculations.

Daylight simulations indicate that the restaurant has an excessively high amount of daylight. To face this issue, it was attempted to lower the glass area and replace the subtracted amount by discs of solid envelope.

The internal space of the restaurant was influenced largely by the proposals, the one with discs replacing 50% of the glass created a very dark 4000 mm gap to the ceiling, which disturbed the harmonious perception of this transparent space.



DAYLIGHT ANALYSIS

3.5 PHASE 5

Issues with excessive daylight in office spaces and the activity rooms were apparent during the final stage of the design proposal development. The office spaces were excessively light with daylight factors of 5-6% on the whole area, which is quite higher than the recommended 3%. The windows widths were altered from 1300 mm to 1000 mm, which in turn reduced the overall daylight factor to 3-4%. The activity rooms had an average daylight factor of 14% with the 8000 mm tall glass panel,

and by reducing this height to 4000 mm, the daylight factor got reduced to 7%. The implementation of the disc above the glass panel created a possibility of external exhibition on the facade. Worth noting is, that while 6% daylight factor is excessively high in the context of a working environment, 7% in an activity room with varied activities and occupational time is not extreme, since the issue with glaring occurs at approximately 1200 lux, which is equivalent to 12% daylight factor.

Daylight factor

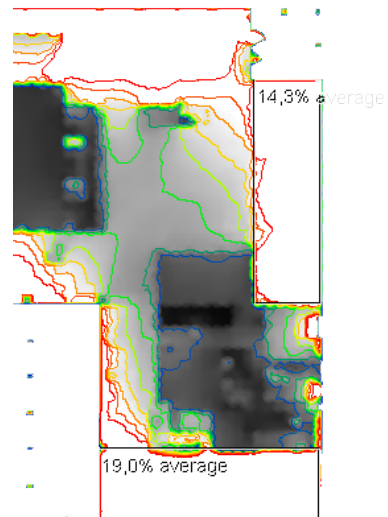
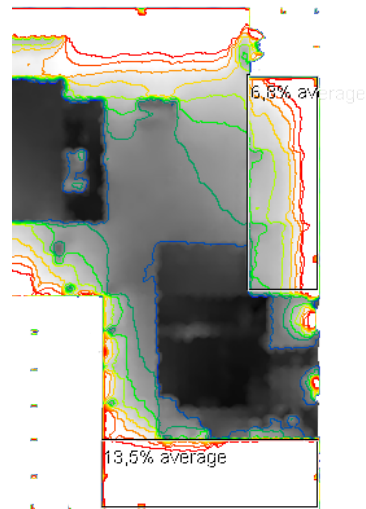
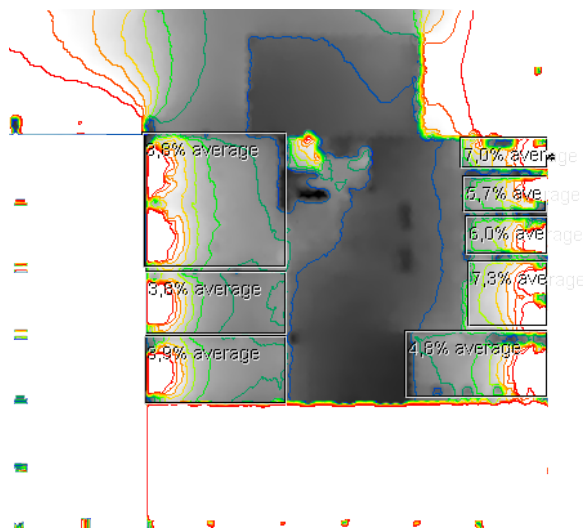

Ill. 238

SUB-CONCLUSION

3.5 PHASE 5

The proposal is in a state where all previous problems and issues have been solved. The building volumes at A10 and A11 are coherent in function and aesthetic. The freedom in exhibition narrative is large within A11 and A10, and the constructive system supports freedom in technical installations and flexible plan solutions.

The urban development through the two sites activates the previous industrial areas into gathering places for the community in Oslo, filled with the character of the photographic museum. The harbour front is activated into multiple functions including bathing, kayaking, sunbathing, a beach, outdoor fitness, outdoor exhibition, parks, and greenery in multiple stories. This acts as a large area that connects people across generations and backgrounds and introduces cultural purpose through a photographic exhibition, which allows all visitors to leave the area with a newfound knowledge or perspective on a subject. The enlightenment and knowledging people is a main focal point in the vision of the project.

DESIGN PROCESS SUB-CONCLUSION

Working with the design process through five separate phases, where each reflecting the newfound knowledge from the previous phase, supports the idea of a hermeneutic and iterative approach to the design process. In general, the initial parts of the design process were rough modeling and sketching to identify a direction and create an overview of possibilities in relation to the context. While the later phases in the design process required detailing and specific drawings to understand the usage of

the building by visitors as well as the staff. Through the sketches and discussions in the group attain new knowledge regarding multiple aspects of the development such as functional or aesthetical aspects. The newfound knowledge becomes integrated into the design process, which ultimately becomes a building with a lot of thought put into the functional planning and the orientation and dimensions of various rooms.

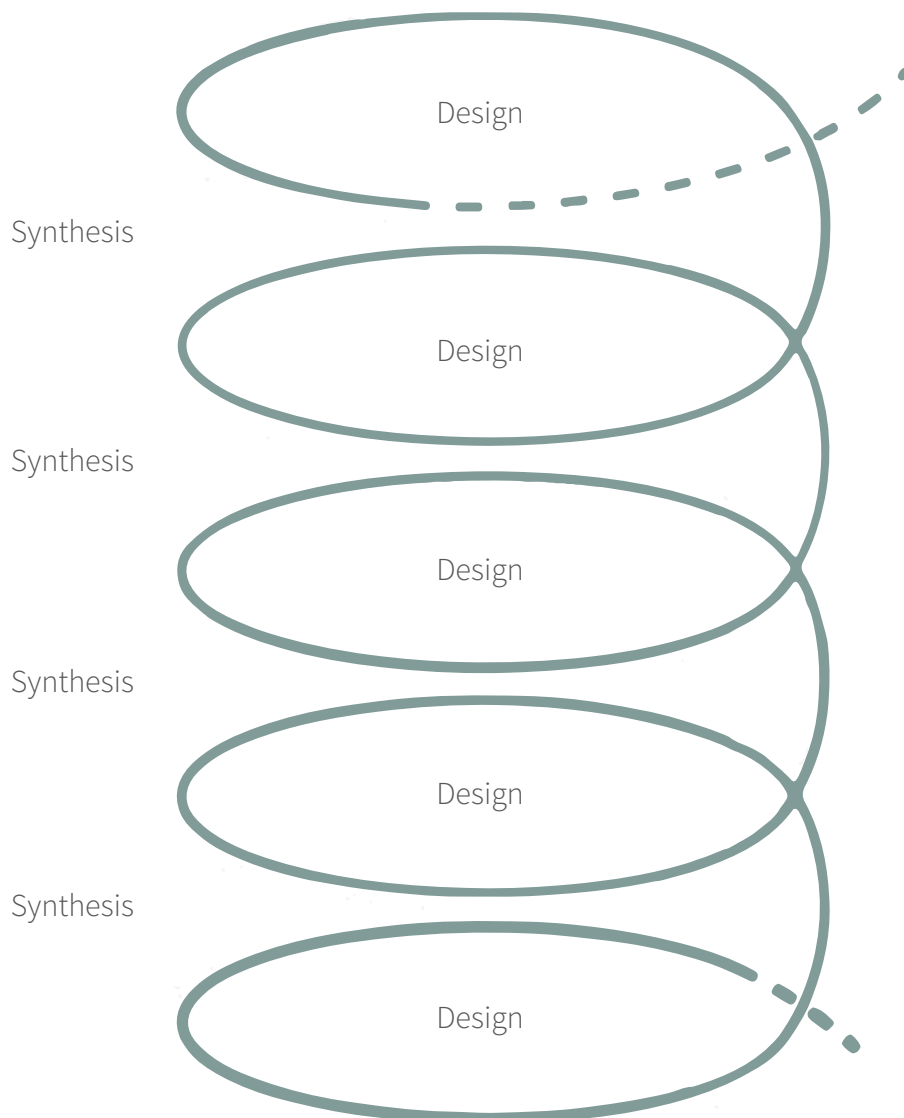

Ill. 240

04 PRESENTATION



Masterplan 1:1000

III.241





Arrival at the museum by night

Ill. 244



Arrival from the Oslo Opera

Ill. 245

PLAN DRAWINGS

The A10 buildings

Gross area 720 m²

Net area 682 m²

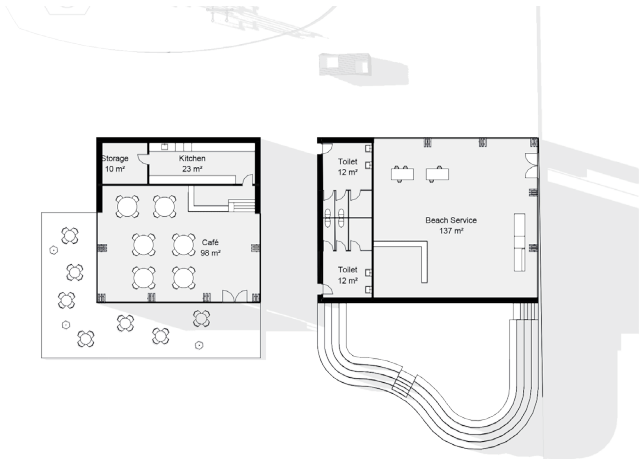

The A11 building

Gross area 3865 m²

Net area 3621 m²

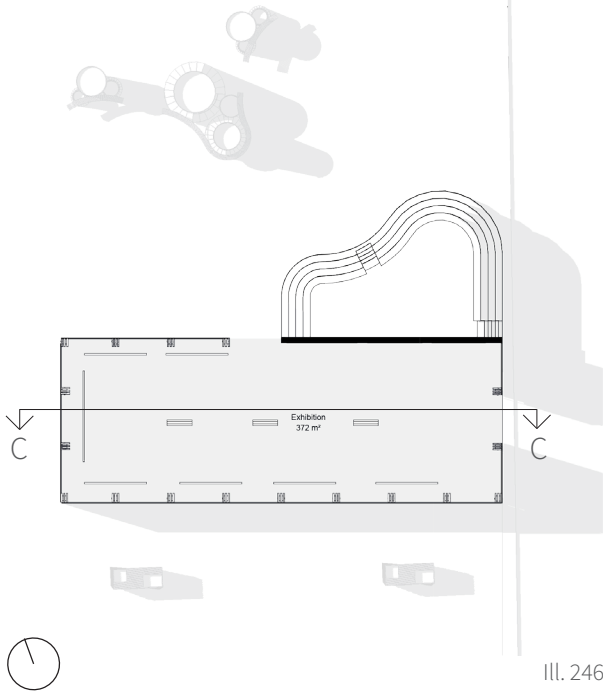

A10 plan drawing 1:500

A11 plan drawing 1:500
Basement



III. 246

III. 247

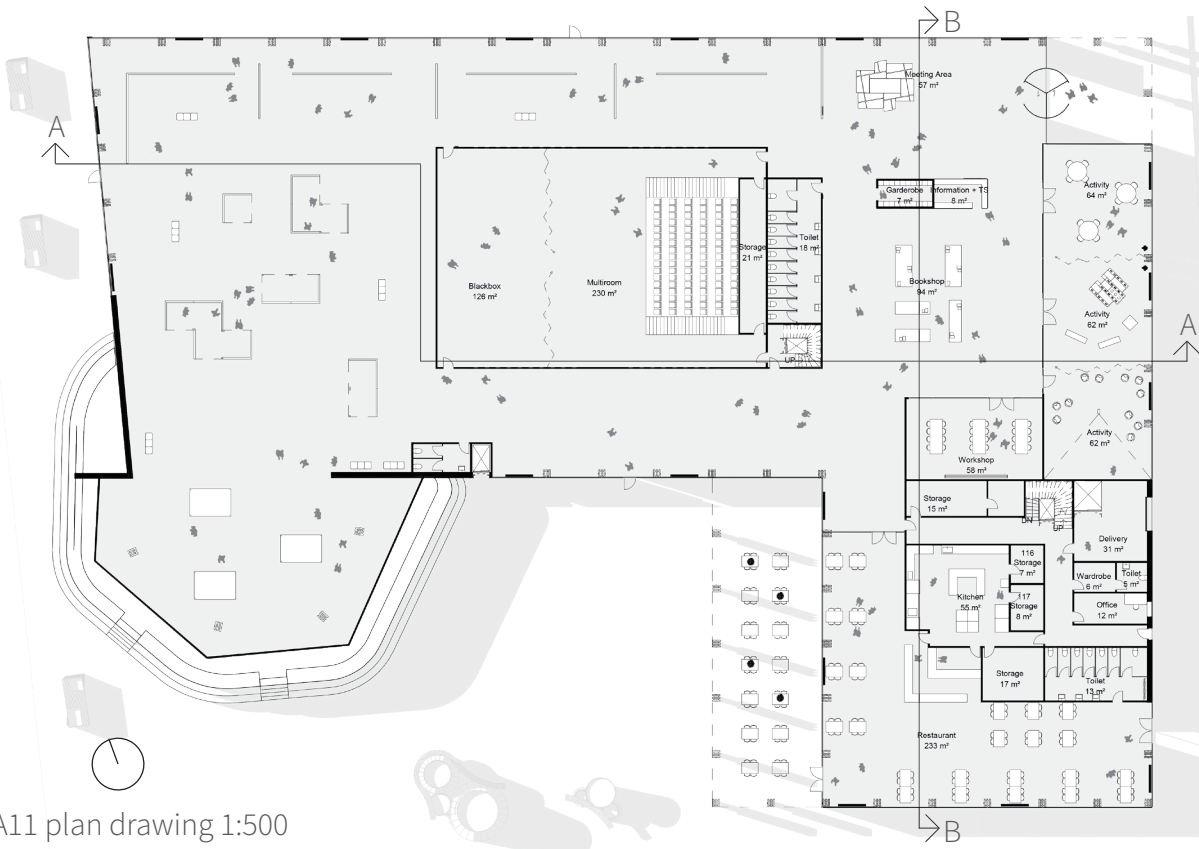

A11 plan drawing 1:500
Ground floor

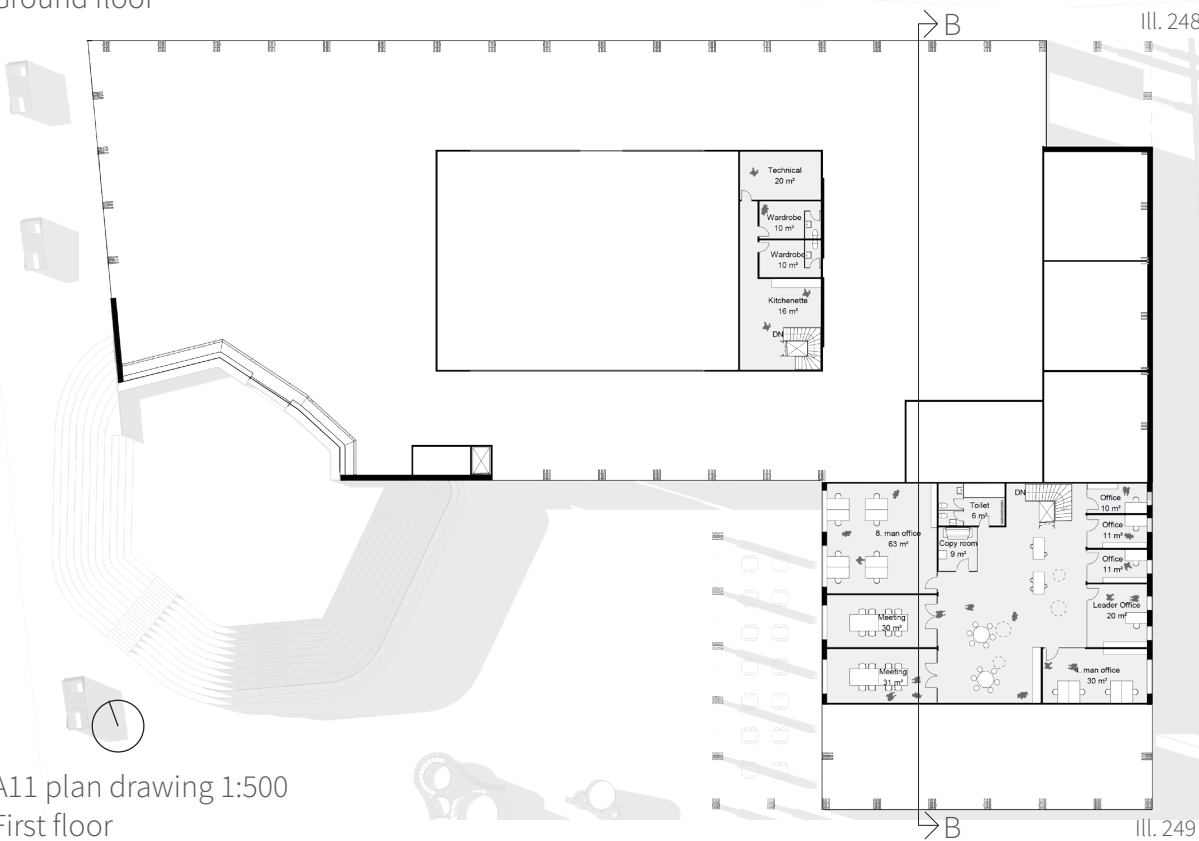

A11 plan drawing 1:500
First floor

THE CONCEPT

The overall concept derives from a single volume, where the harbour and the roads are subtracted. Following the reduction in volume, the urban areas and event plazas are shaved from the volume. The access to the roof is established from the urban

areas, and a pavement indicator defines the relation and coherence between the plazas. Finally, volume is subtracted from the roofs to establish seating facilities with specified viewpoints.

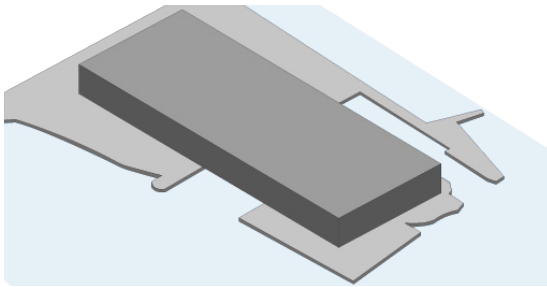

1. One massive volume

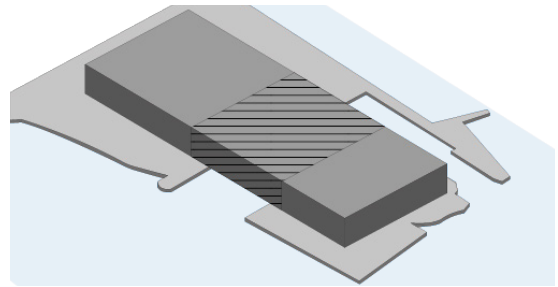

2. The harbour is subtracted from the volume, dividing the mass into two

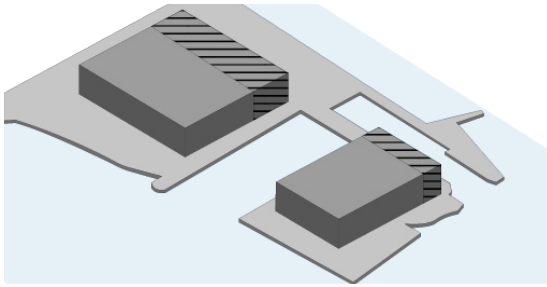

3. The roads are subtracted from the mass

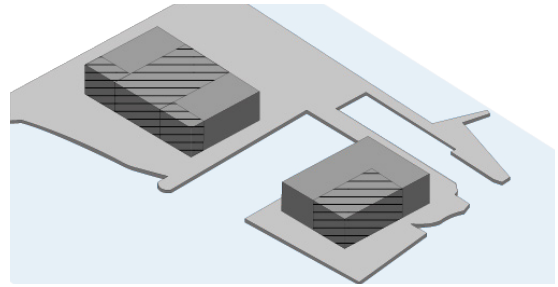

4. The urban areas are cut out of the two masses

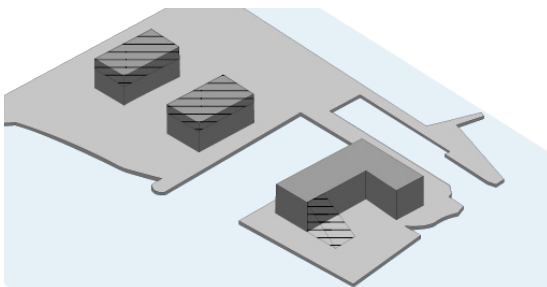

5. Height differentiates and access to the roof is established

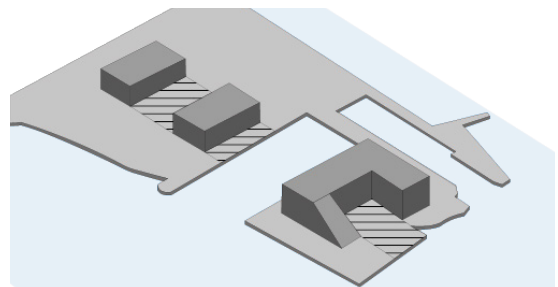

6. The event strip is created to establish a connection between the two buildings

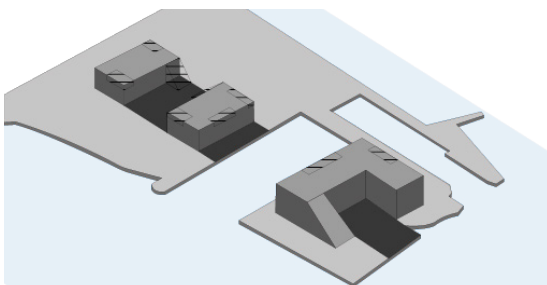

7. Mass is subtracted from the roofs to establish seating areas

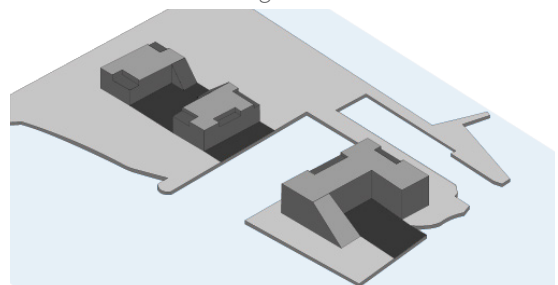

8. Finalized concept diagram

III. 250



The museum foyer

III. 251



The bookshop, activity rooms and workshop

III. 252

CONTEMPLATION AREAS

The exhibition areas are defined as areas of contemplation and are structured as varied experiences. The exhibition area at A10 is a covered exhibition area, with large openings in the facade. The strategy is to develop suspended wall elements that limit the lighting and create an area that exhibits topics relevant to the context and users. In this case, A10 is in close proximity to a beach, and the visualizations present topics of body positivity and showcase the beauty of Oslo. This is thought to induce an interest of photography for the viewer,

inviting them into the main museum and main exhibition areas. The exhibition areas in A11 are thought to have large-scale exhibitions towards the northern facade, and smaller, analogue exhibitions in the middle area. The visualizations show a proposal of the comprehensive exhibition with the covers directing people around in the exhibition area. The last exhibition area is a digital exhibition area with controllable conditions. The purpose of the digital exhibition is to be convertible and stay relevant.

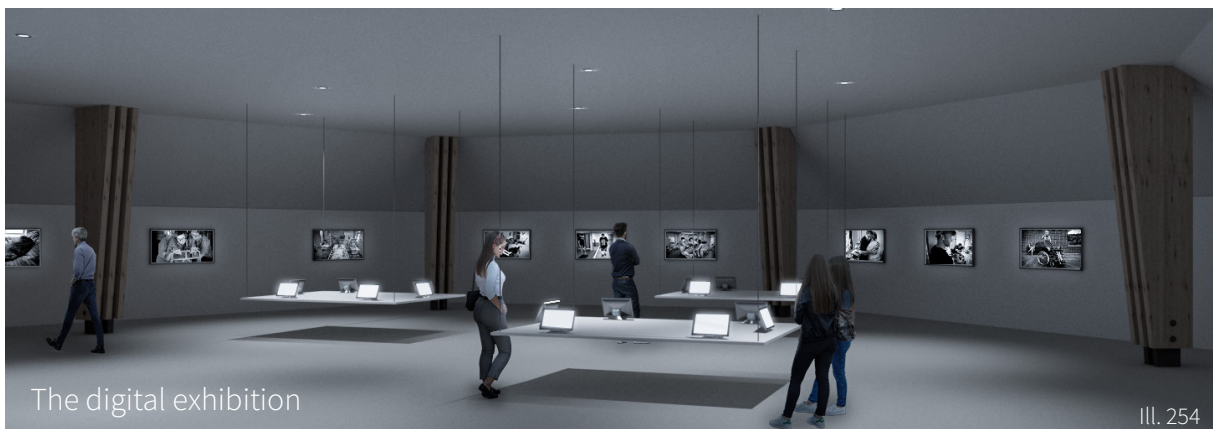



Transition between large-scale and medium-scale exhibition

III. 255



The large-scale exhibition

III. 256

THE MULTIROOM AND BLACKBOX

The multiroom is the duality-based area in the museum, which acts as contemplation or activity, based on the intended purpose by the organizers. The diagrams attached to these pages address various purposes. Overall, the blackbox and multiroom potential lie in fulfilling the demands of enlightenment, entertainment, and education. Through its intention, the

enlightenment element is an active asset to the exhibition with its retractable walls and controlled environment. The entertainment element in its duality of the exhibition, lecture hall, workshop, and movie exhibition. The education element through its intention as a workshop and lecture hall.

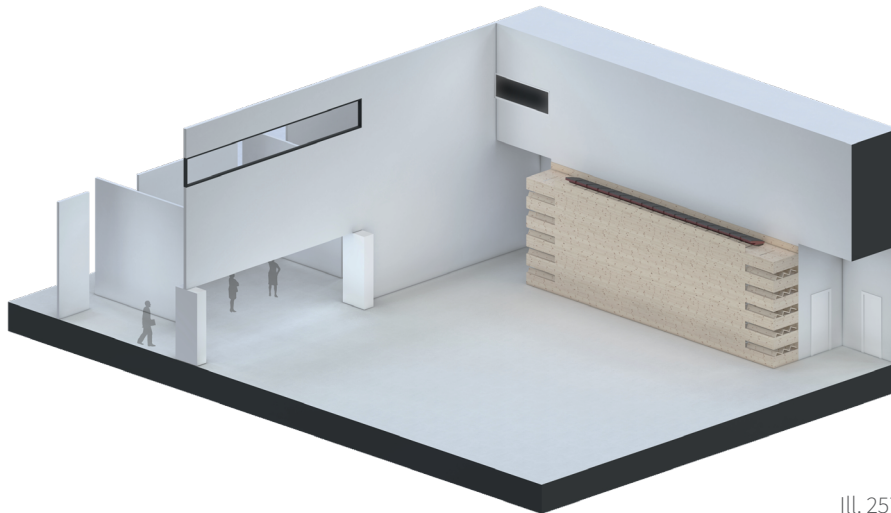

III. 257

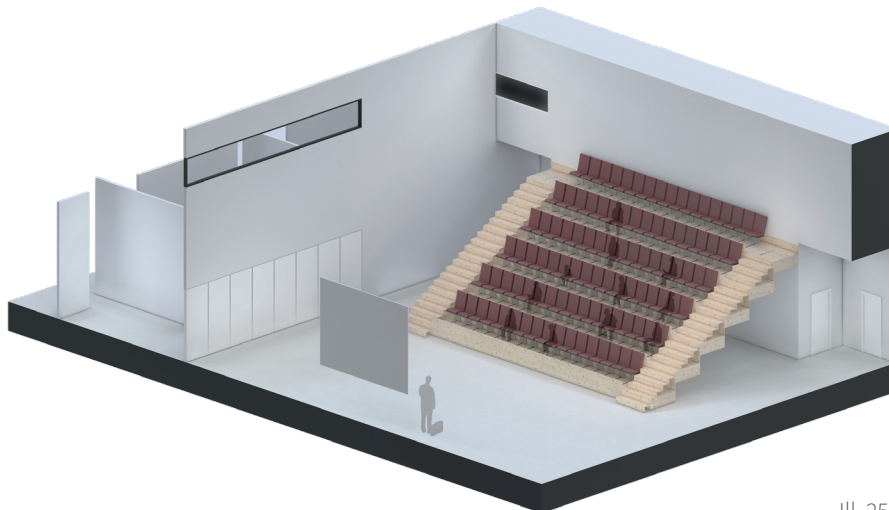

III. 258

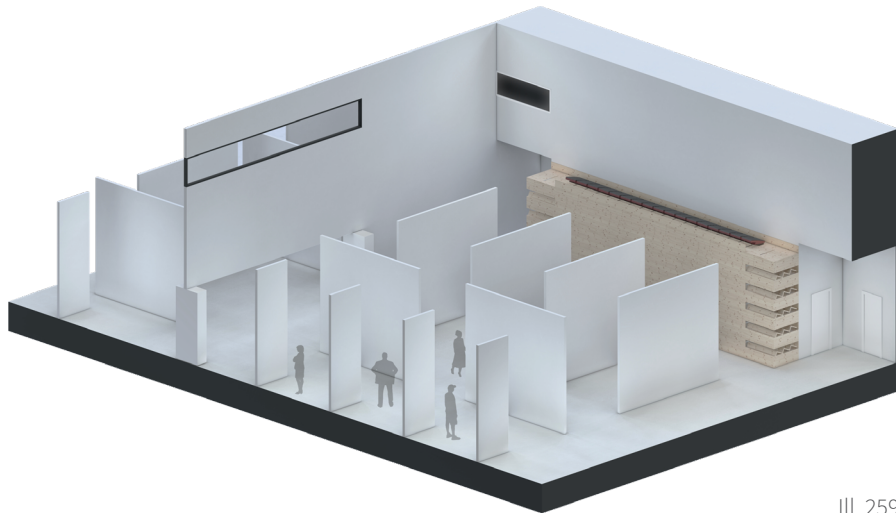

III. 259

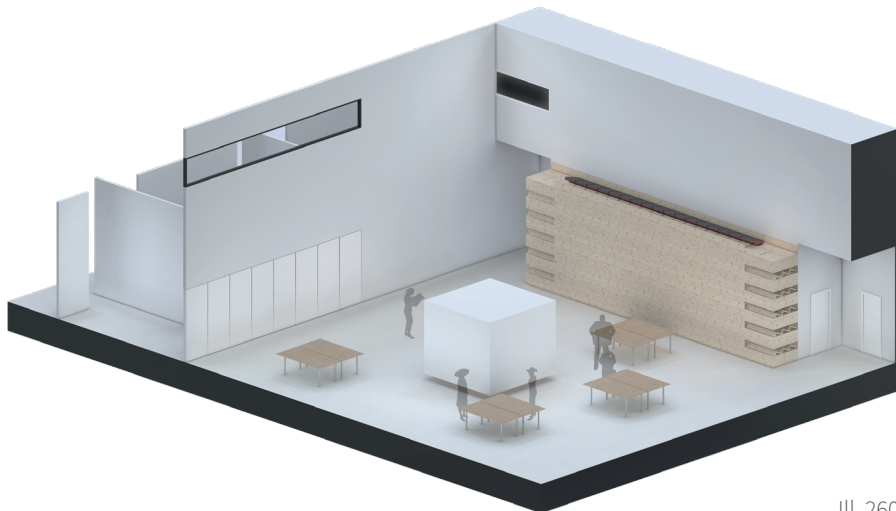

III. 260

ZONE DETAILING

The project defines “zones” as two overall categories; activity and contemplation. The core goal was to create a harmonious relation between them. The primary museum at A11 has a soft line drawn, that distinguishes between activity and contemplation, in which the users of both facilities do not interfere with each other. The multiroom becomes a duality since its function can be altered based on the intention, so the placement reflects its flexibility in usage.

The buildings on A10 are equally separated into contemplation and activity. Activity is placed in the northernmost building, which relates itself to the surrounding urban development, and provides various social activities. The southernmost building contains an exhibition and is in direct communication with the contemplation zone on A10.

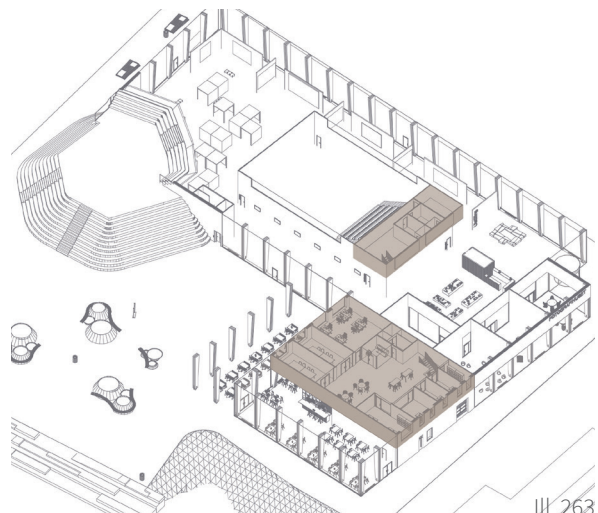
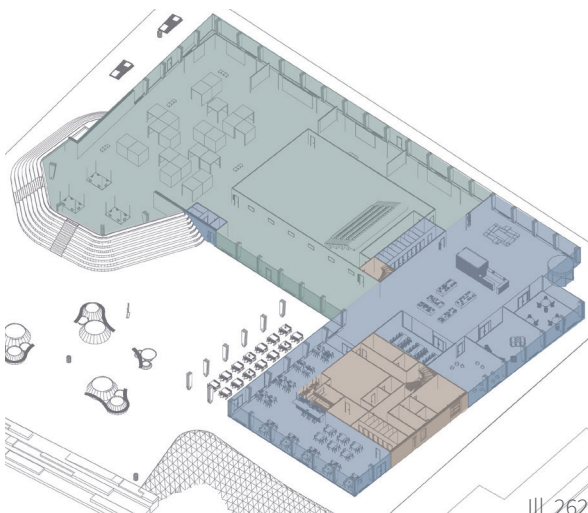
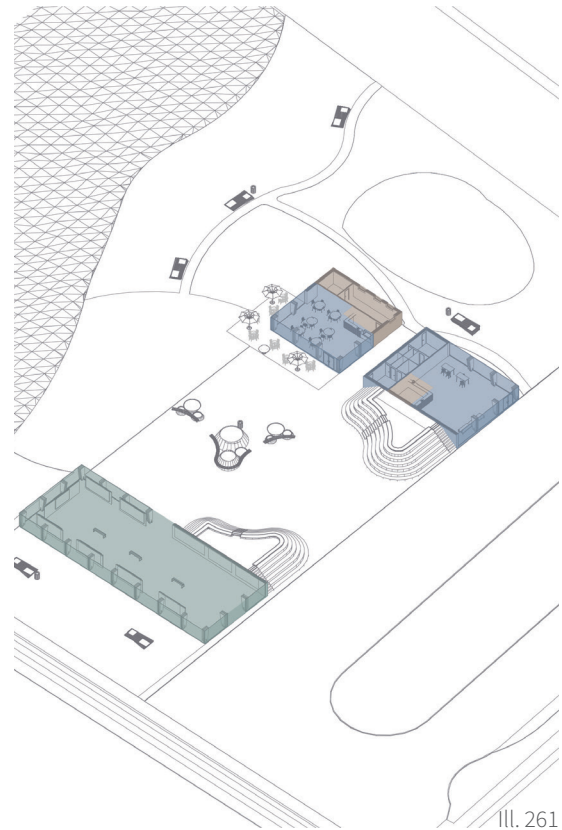



FLOW DETAILING

The flow diagrams are structured through various sections to differentiate between them. The color of the lines represents the perpetrator, with the dark blue suggesting the movement of the visitor, while the light green represents the movement of the employees.

The urban flow charts indicate the arrival points of the site visitors and suggest possible movement patterns to understand the connectivity between the urban furniture, the exhibition, and how the roof inte-

grates into the urban movement between levels.

The interior flow charts suggest a large degree of flexibility and determination by the visitor. The visitor is not forced to move between destinations to arrive at the desired function. The exhibition area at A11 suggests a large degree of freedom in terms of visiting the particular exhibitions desired, while also presenting the possibility of investigating every exhibition in a natural flow.

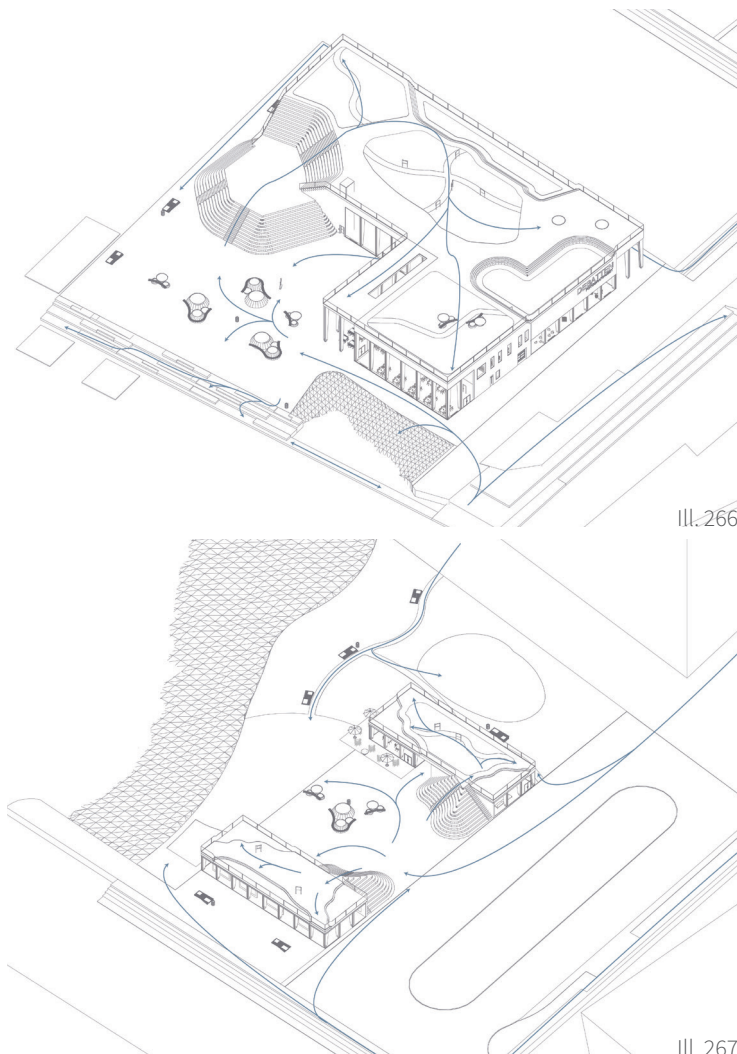

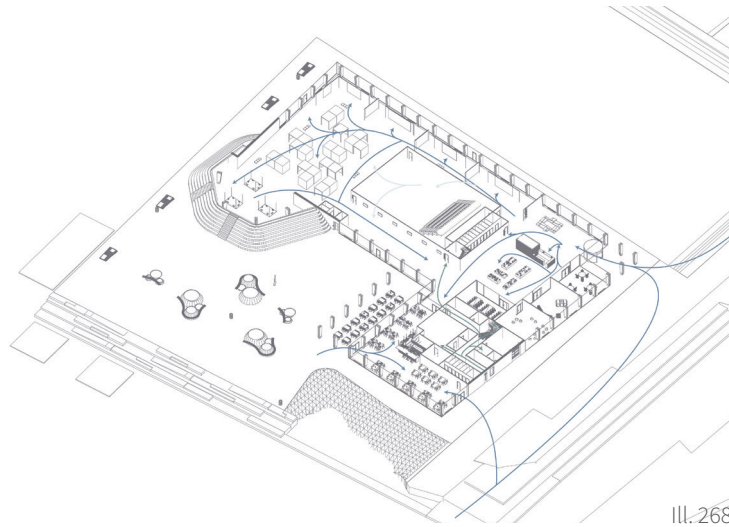

III.268

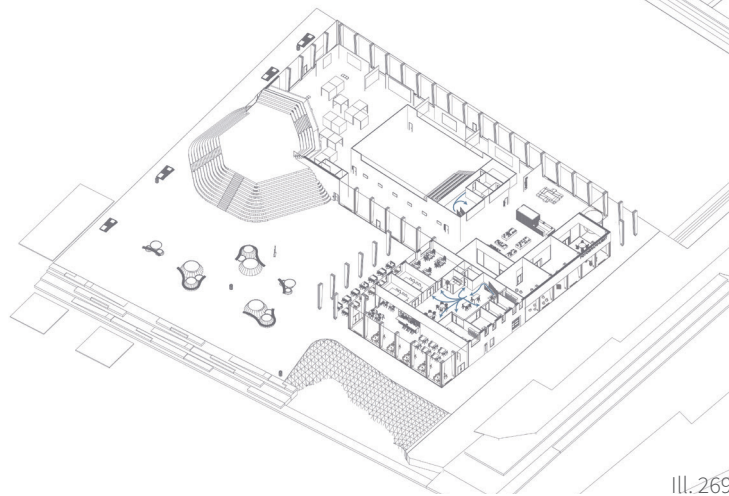

III.269

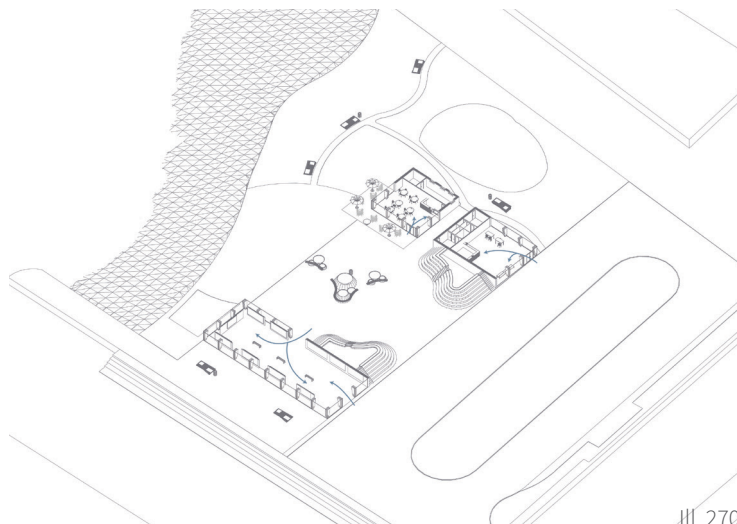

III.270

ELEVATION DRAWINGS



III. 271



III. 272

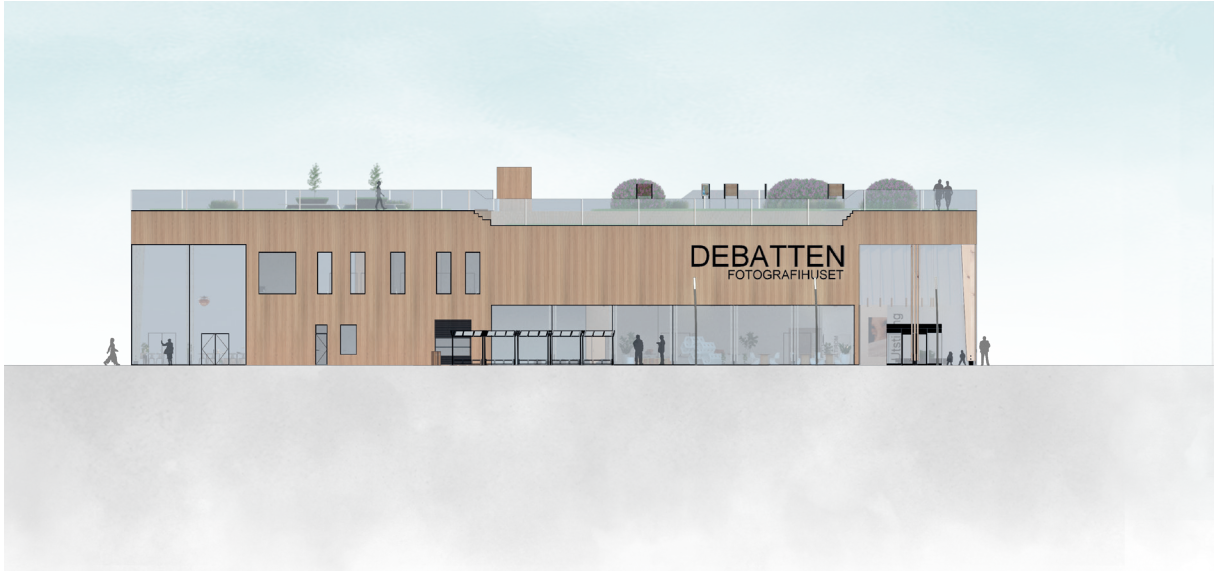

A11 elevation drawing 1:500
East

III. 273



A11 elevation drawing 1:500
West

III. 274



A10 elevation drawing 1:500
North

III. 275



A10 elevation drawing 1:500
South

III. 276

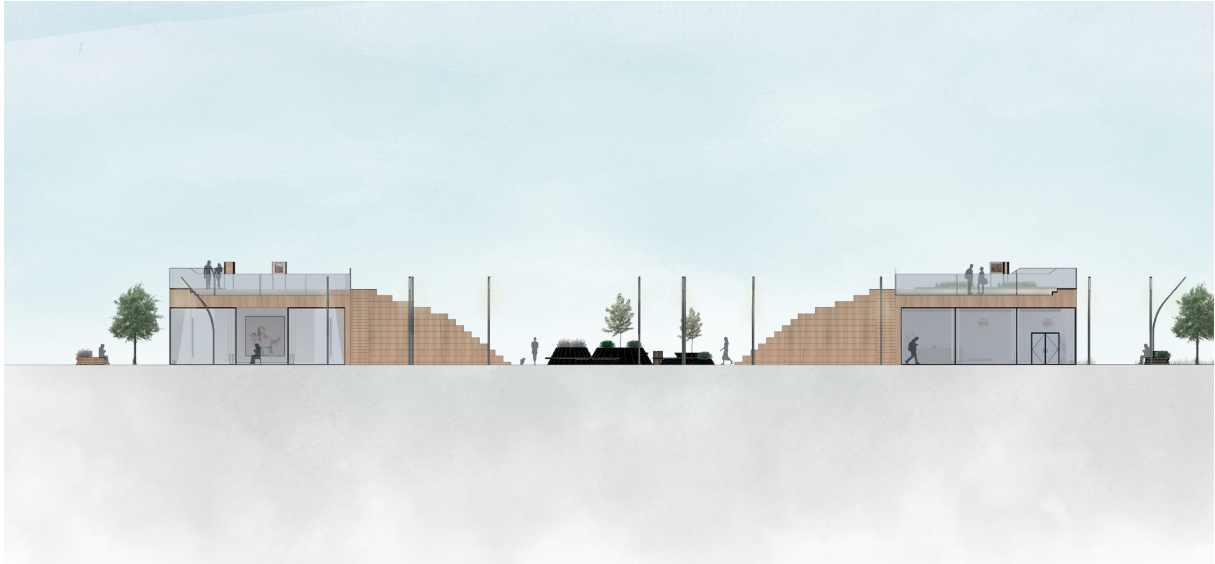

A10 elevation drawing 1:500
East

III. 277

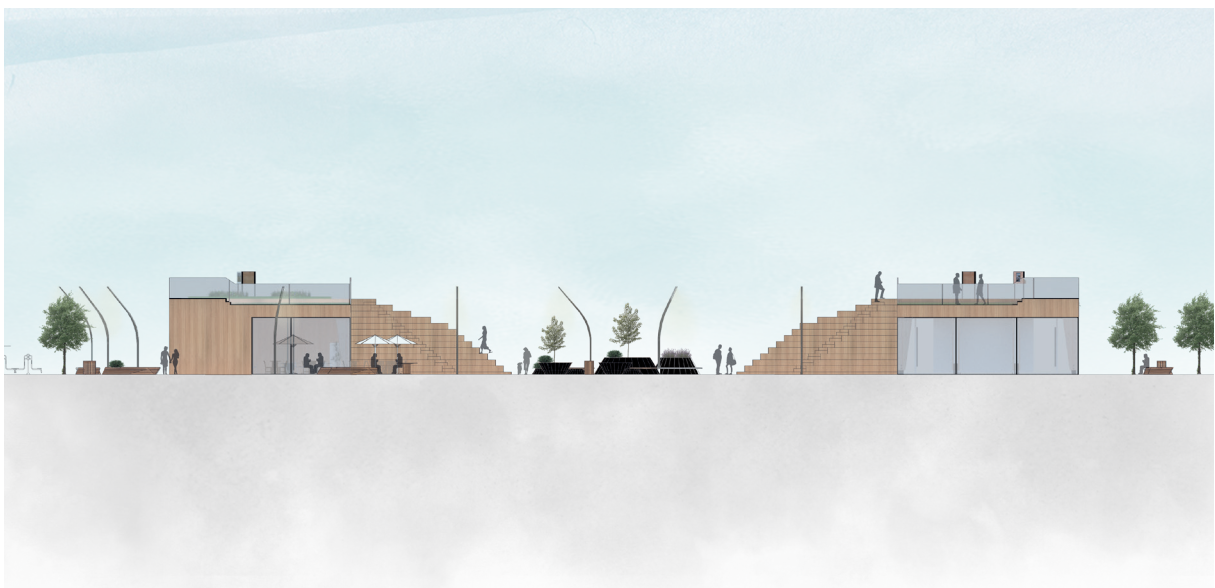

A10 elevation drawing 1:500
West

III. 278

SECTION DRAWINGS

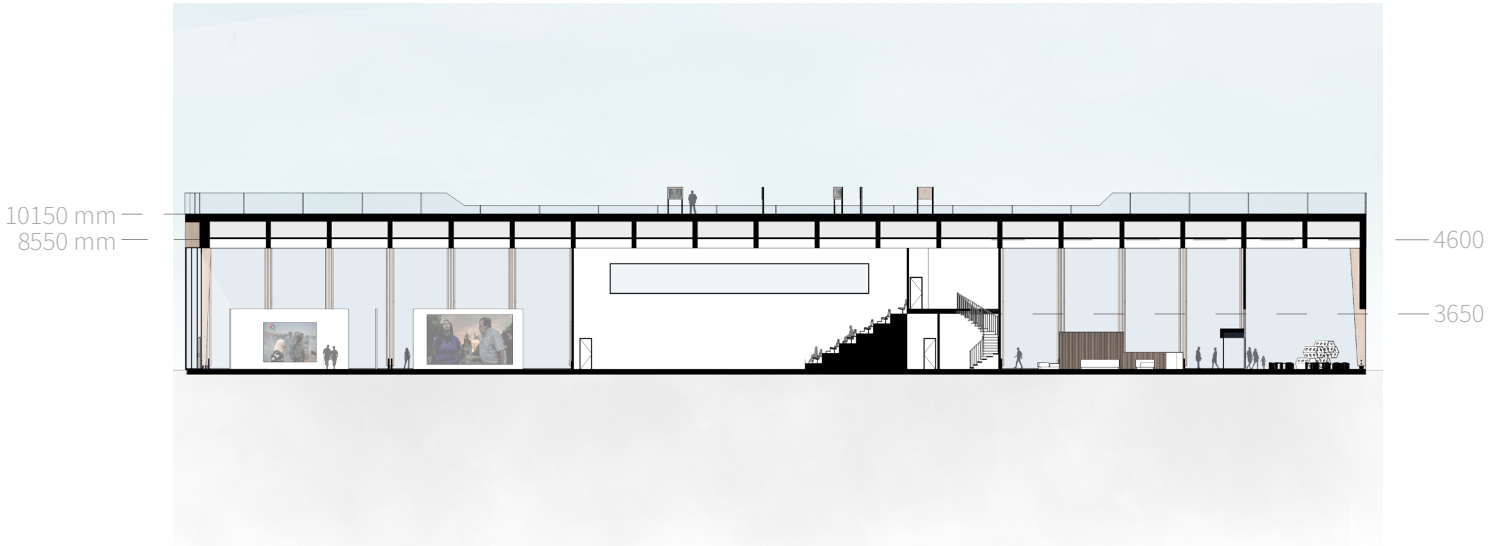

A11 elevation drawing 1:500

AA

III. 279



A11 elevation drawing 1:500

BB

III. 280



A10 section drawing 1:500
CC

III. 281



The staff area

III. 282

URBAN AREAS

The urban areas designed in this project consist of social benches which introduce greenery onto the site without perforating the existing site. The benches act as resting places and are placed intertwined with outdoor exhibitions to facilitate social interaction between various users. The fitness area is a product of inviting alternate user groups to the site. Alongside the benches, a peer has been designed which leads people to the water surface and presents floating bathing docks and a kayak dock.

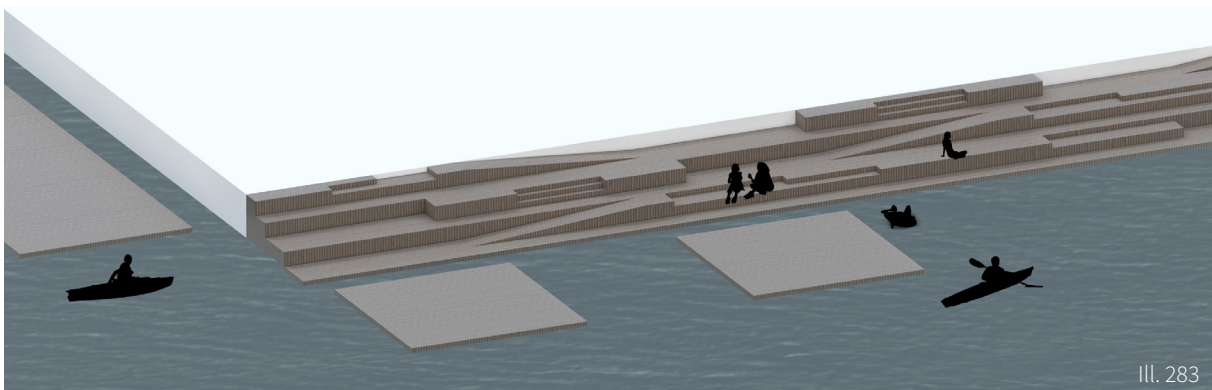
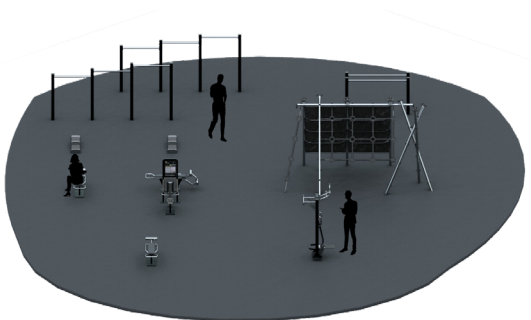

III. 283



A11 Urban area

Ill. 284

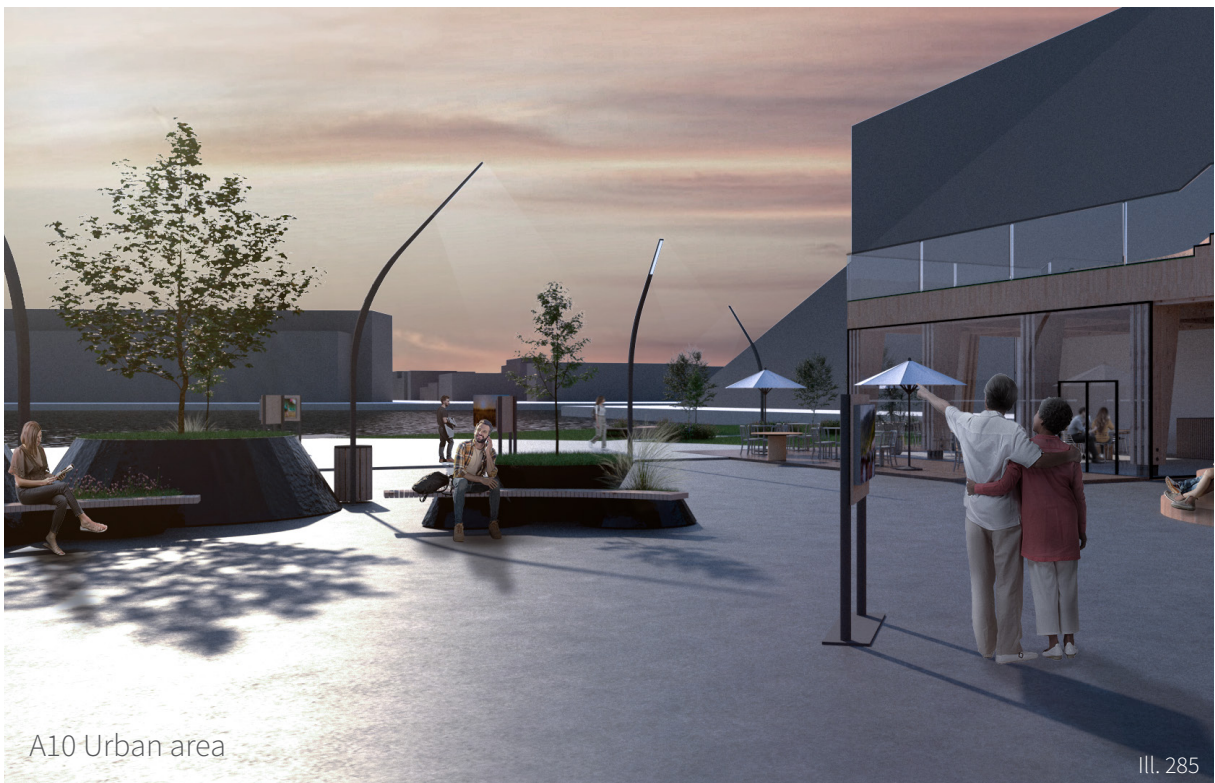

A10 Urban area

Ill. 285

MATERIAL PALETTE

The material palette of the House of Photography is simple and minimalistic. The majority of the materials are natural materials with low impact on the environment. The natural materials have the aesthetic benefit of varying in its development, which creates dynamic variations along a surface, as opposed to steel or basic concrete.

Pinewood - construction material

Pine is utilized frequently in the design proposal. Due to its abundance in accessibility and mechanical properties, it is a widely used wooden type to be implemented as the construction wood. The pine in the project is therefore most present in the beams and columns, as they are structured from this material, and the suspended ceilings are made from pine veneer. As mentioned previously, in the study of wooden materials, the lifespan of pine is anywhere from 40 to 85 years when exposed to moisture, but in a dry and ventilated indoor environment, the lifespan is expected to exceed 100 years (træ.dk a, 2016).

Cedarwood - cladding

The facade cladding is composed of a cedar veneer from the core part of the giant Scandinavian branch of cedar. The Scandinavian branch is chosen due to both its accessibility and reduced transport time, but also due to its climate adaptation during its growth, which ensures longer lifespans as the wood is hardened to the environment. As previously mentioned in the study of wooden materials, cedar contains a high amount of phenol, which protects the wood against rot and fungus. This also ensures that the wood does not need treatment to maintain its long lifespan of 40 to 70 years.

Clay Plaster - interior cladding

The interior walls in the museum are a composition of wooden battens, woodfibre boards, and a natural clay finish. The clay finish relieves the wall of the requirement of paint or treatments, while it is a material that regulates and stabilizes the humidity of the room. It's considered to be a healthy alternative to paint, as it is naturally pigmented and free of toxic ingredients, while also being fully compostable. The light reflection properties of the material are equal to that of gypsum, and its natural softness aids in regulating acoustics by absorbing up to 20% of the reverberation.

Linoleum - Interior flooring

Linoleum is a slightly soft material to use as flooring, this increases the sound absorbance and reduces the reverberation time and the impact sound. The material is also chosen from its lifespan, ease of maintenance and cleaning, and neutral surface that compliments the notion of putting the exhibited material in focus.

Concrete - Foundation and basement

From a sustainable point of view, concrete is inferior due to its emission and decomposition. However, it is the material most suited and adaptable when designing foundations and basement walls, due to its mechanical strength, and the possibility of exposing it to high degrees of moisture without risking the mechanical strength.

Steel - Column foot

Steel is generally considered to be a poor material in considerations of environmental impact, however, it is superior to concrete since the material can be repurposed and melted into other forms and functions with relatively low additional impact, thereby multiplying the lifespan of the material (Larsen, 2020). Steel is excellent as a

material that touches the ground and is exposed to the environment. This is the reason that steel is implemented as a footing for the wooden columns, to act as a medium of transporting internal forces to the ground, while prolonging the lifespan of the wooden columns exposed to the outdoor environment.



Wooden construction



Wooden cladding

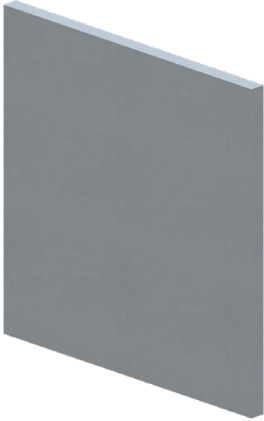

Clay plaster

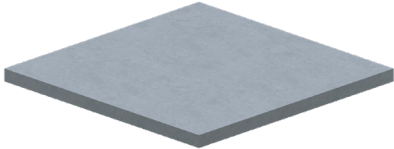

Linoleum flooring



Concrete foundation



Steel footing

THE SUPPORTING STRUCTURE

The constructive system is based on avoiding any supporting structure interfering with the degree of freedom in the plan. The construction is thus implemented in the facade, with large spanning beams in the ceiling. The columns are spaced 4 meters apart, and the double-spanning beam deck fulfills the 4 by the 4-meter grid. Along the periphery of the building are beams ensuring stability against wind and horizontal forces. The sole supporting structure visible in the plan is the back wall for the ventilation shaft. This supporting structure allows the upper beam to be split, creating a passageway for ventilation ducts to connect into the exhibition area (see appendix 3).

Upper layer of beams

Width: 300 mm
Height: 2000 mm
Material: GL30C
Calc. strength: 18.4 MPa
C/C: 4 meters
Span: 4 meter elements
Static check: $0.8 \text{ MPa} < 18.4 \text{ MPa}$

Lower layer of beams

Width: 300 mm
Height: 1500 mm
Material: GL30C
Calc. strength: 18.4 MPa
C/C: 4 meters
Span: 30 meters, supported at ends
Static check: $16.9 \text{ MPa} < 18.4 \text{ MPa}$

Columns

Central section width: 100 mm
Central section depth: 500 mm
Material: GL30c
Calc. strength: 13,3 MPa
C/C: 4 meters
Static check: $0,25 < 1$

- 1. Double spanning beams
- 2. CLT slab
- 3. Supporting columns
- 4. CLT discs
- 5. Concrete base

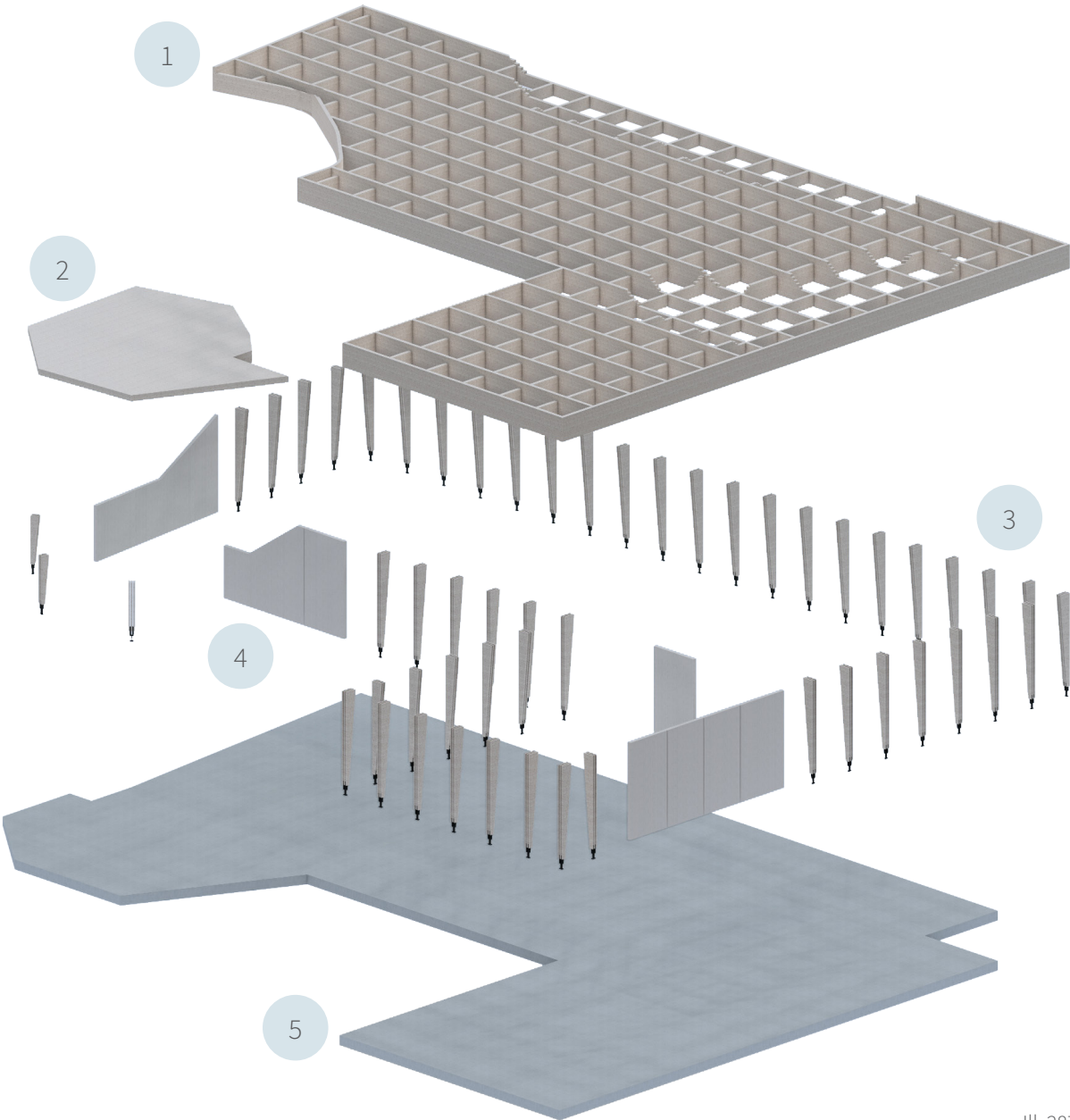

DESIGNING FOR DISASSEMBLY

The idea of designing for disassembly is to avoid using glues and sealants, as these solutions contaminate the material, reducing the efficiency of the end-of-life phase, as well as complicating disassembly. By designing the building from an entire mindset revolving around designing for disassembly, the building becomes portable, allowing House of Photography to

relocate in 20 years if they so desire. This is done by using dowels rather than glues and utilizing the physical forces to tighten the joints, thereby preventing displacements. In areas where dowels or section interferences are not suitable, it is preferred to utilize steel and bolts, as this type of joint does not contaminate the raw material.

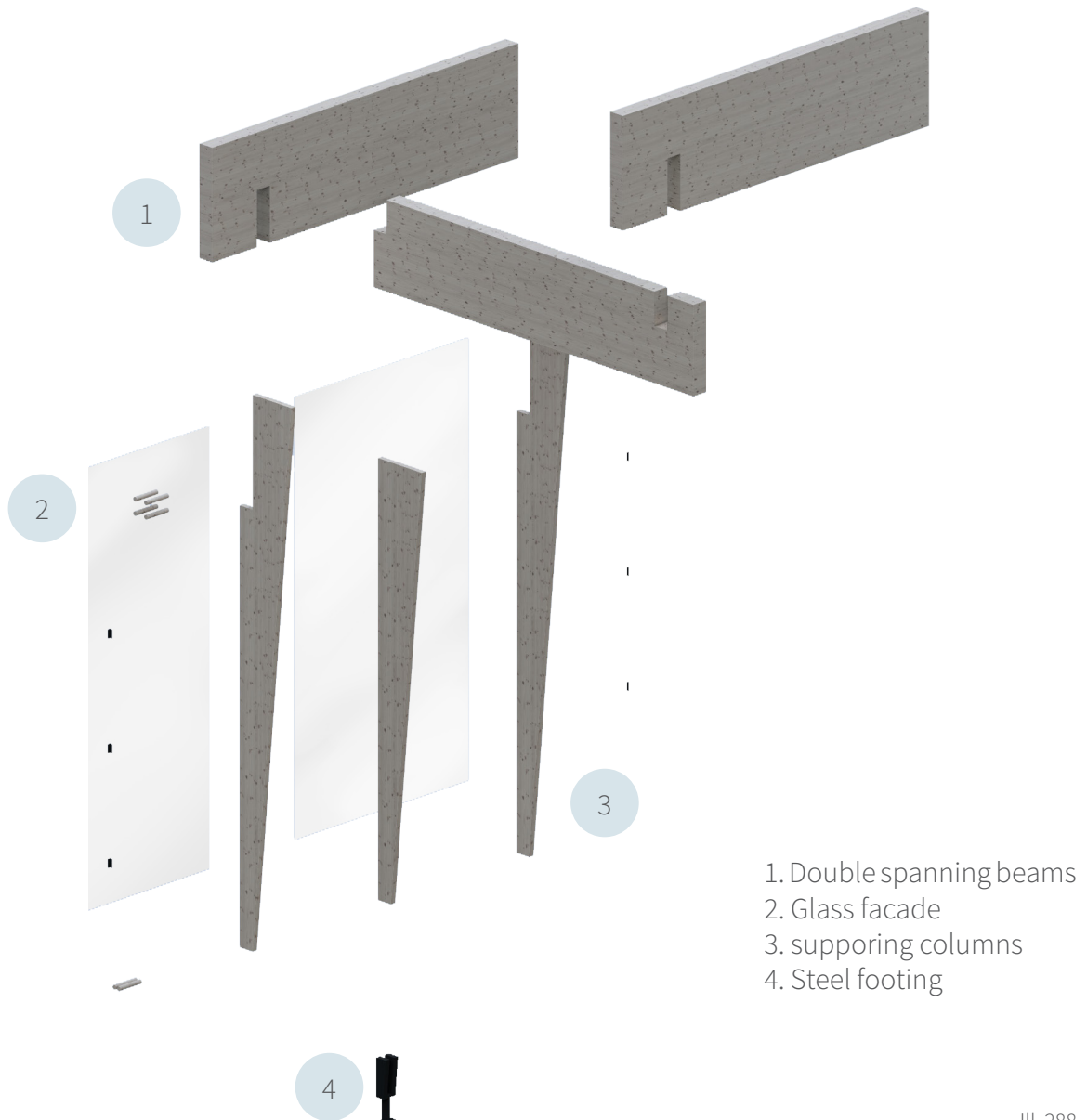

1. Exhaust pipes
2. Cable tray
3. Double spanning beams
4. Batterns
5. Suspended ceiling
6. Exhaust filter
7. Light source

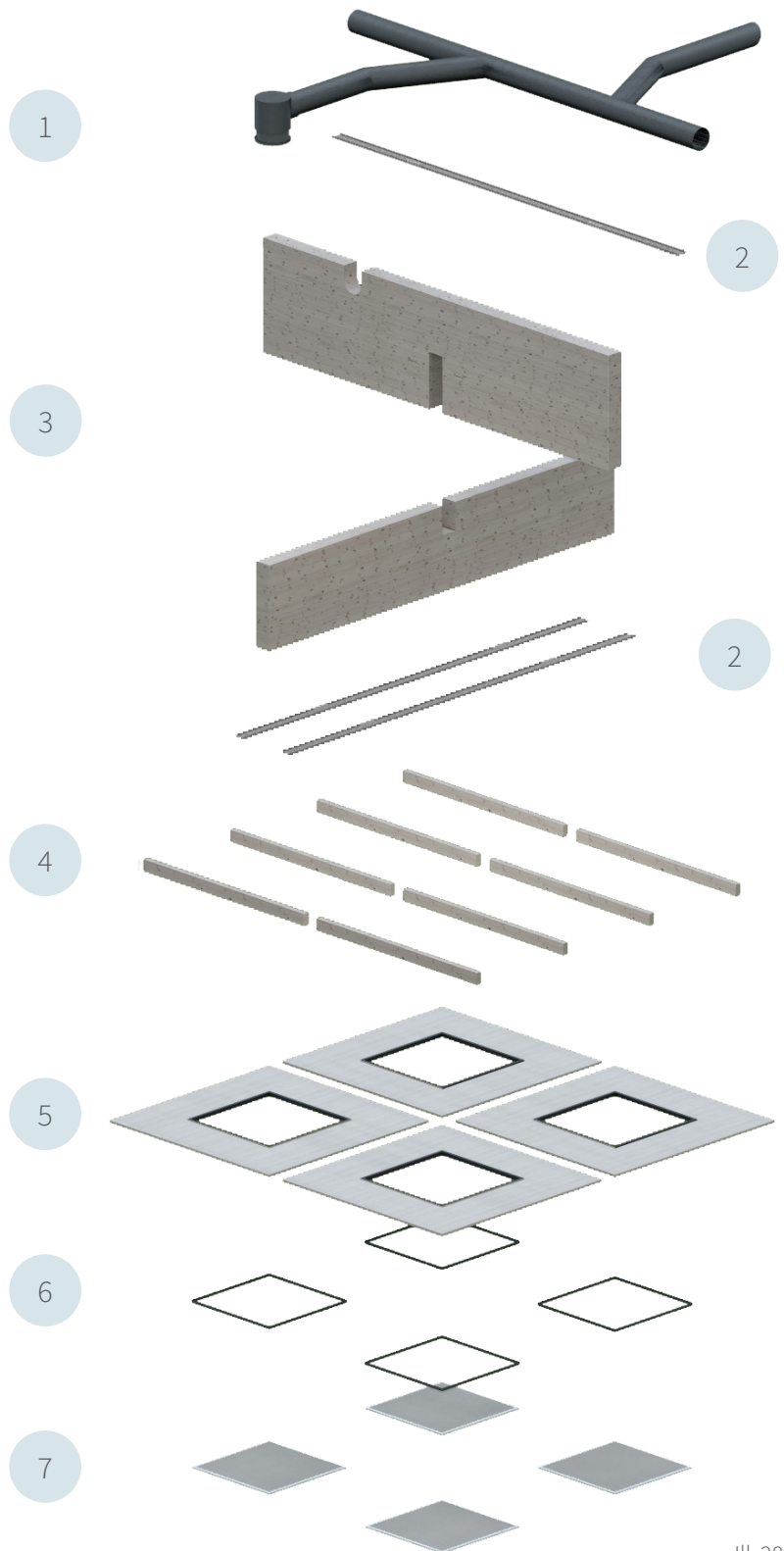

III. 289

DETAIL DRAWINGS

Assembly of beams and columns

The columns are architecturally crafted with transparency in mind, considering the column is based on three discs with a cavity in between. The width of the column is 500 mm in total, which allows the 300 mm wide beam to rest on top of the middle disc, with the two peripheral discs connecting to the sides of the beam, ensuring its gravitational stability. The beam and column are fastened with dowels, once again, avoiding the usage of sealant or glue. The constructive system utilizes peripheral beams to ensure spatial stability and ensures the columns don't fail and break due to twisting.

Connection of roof and stairs

The roof is constructed through a CLT-based system. The outer cladding is a cedar veneer, with a ventilated cavity behind. After this, the structural system occurs, which consists of two 60 mm CLT elements, enveloping 240 mm insulation. The interior side of the insulation consists of a vapor barrier, a 50 mm technical layer with strips. Connected to this layer are the clay panels, which function as the internal cladding. The stairs are veneer sheets placed on periodic beams. The beams are perforating the external cladding and ventilated cavity, and are connected to the CLT layer. At the bottom of the upper staircase at A11, the plateau presents initial struggles with the handling of rainwater, and to negate this, a slit has been made along the periphery of the plateau. The slit leads the rainwater to the lower staircase, ultimately leading the water down to the hard urban area, where the natural inclination of the site leads the rainwater towards the sea.

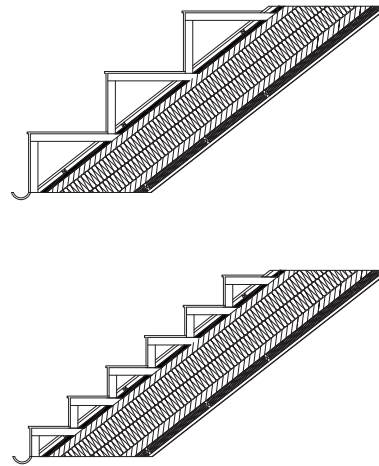

Detail of roof 1:50

Ill. 290

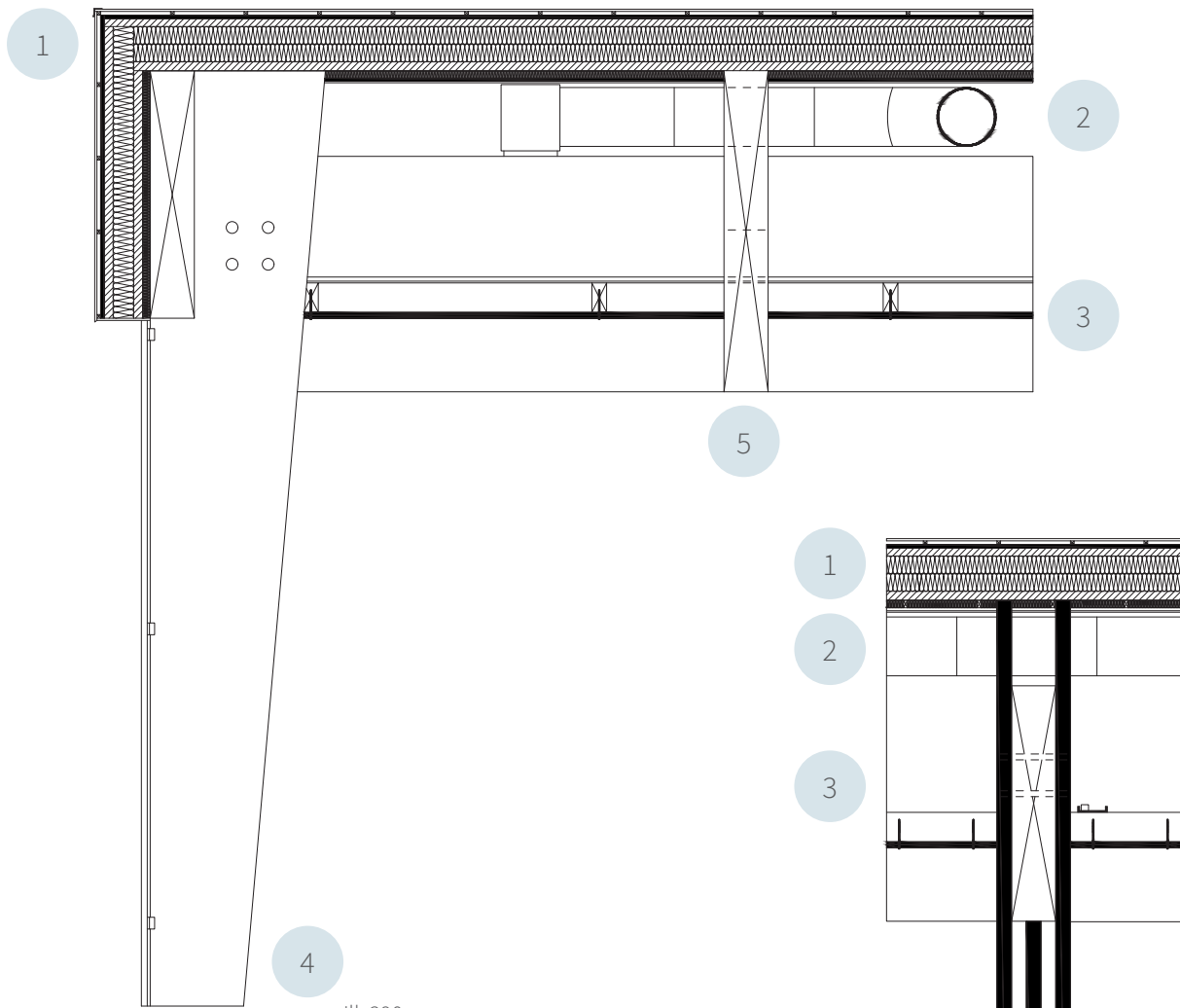

Ill. 290

Detail of Column and beam 1:50

1. Envelope (see page 55, ill. 63)
2. Exhaust pipe
3. Suspended ceiling
4. Supporting column
5. Upper layer beam



Ill. 292

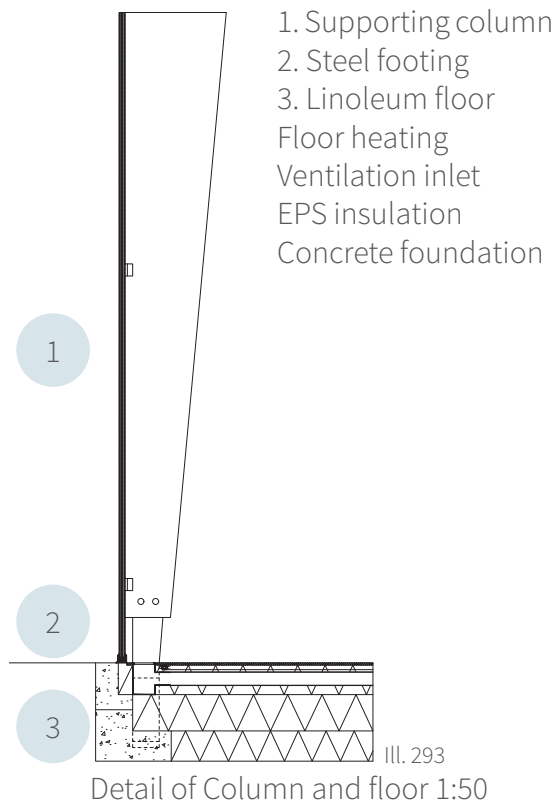

Assembly of column and floor

In between the three discs of glulam are steel discs connected to a steel structure going below the deck. The forces of the columns are large, and creates a huge internal momentum, and thereby enforcing an eccentricity that can topple the columns. To prevent the top element, the steel structures connect below the deck to a concrete block, thereby negating the eccentricity to ensure gravitational stability. In between some columns are ventilation gratings, providing the displacement ventilation required in the interior spaces, to ensure indoor comfort class II is upheld. A total of 14 grids shown are necessary for the exhibition space to ventilate adequately while avoiding draft or noise pollution. The floor material is laminate flooring, which is divided into elements and provides easy access to the technical installations below, while also connecting seamlessly. The heating system of the museum is quick altering ground heating, to ensure equal operational temperatures and removing visual pollution in comparison to traditional radiators. Below the ground heating piping is ventilation piping, providing airflow to the ventilation gratings. Following the four-by-four meter grid are electrical cable trays aside the ground heating pipes, providing a large degree of freedom in terms of installing various exhibition elements.

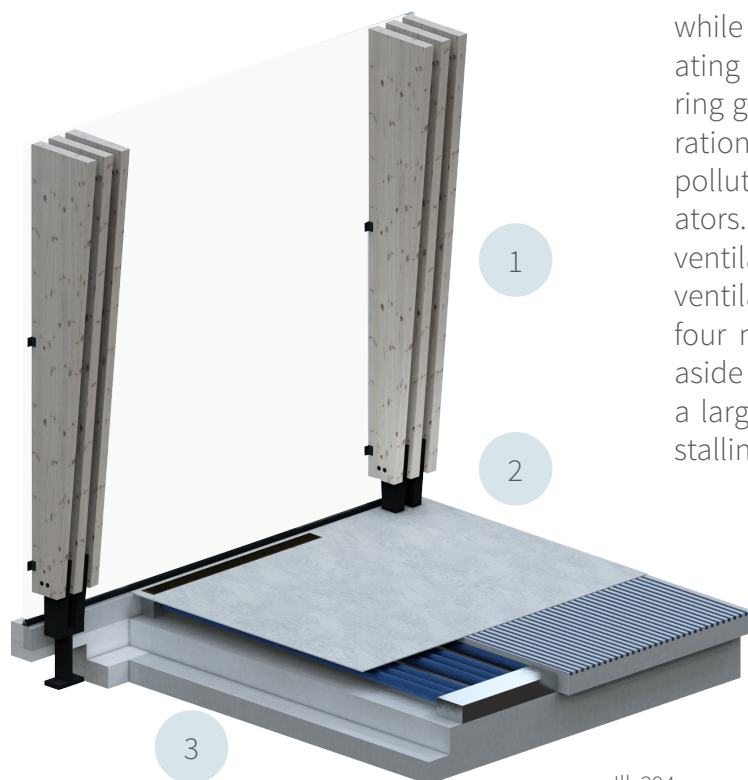

Double-spanning beam ceiling

The purpose of the suspended ceiling elements is to relieve the visual impact of the dimensions of the supporting structure, as well as hosting integrated solutions for lighting, electrical management, and exhaust ventilation. The purpose of the beams spanning from the west to east is to take the initial load of the roof and relay it on the beams spanning from north to south. This was done as a double-spanning beam solution in order to install technical amenities with a large degree of freedom in terms of future implementations and alterations.

The beams connect seamlessly with a joint created by cutting a section of material away from the beam, and sliding the elements into each other, thereby effectively removing the requirement of a sealant or glue to join the elements, supporting the initial statement of DfD. The suspended ceiling connects to the grid by being screwed into two strips connected to the supporting beams. The suspended ceiling contains a suspended lighting fixture, and the gap is covered by a black felt, allowing the stack ventilation principle to lead warm, polluted air into the cavity. Exhaust armatures are placed regularly in the cavity, ensuring adequate change of air, to eliminate the polluted air.

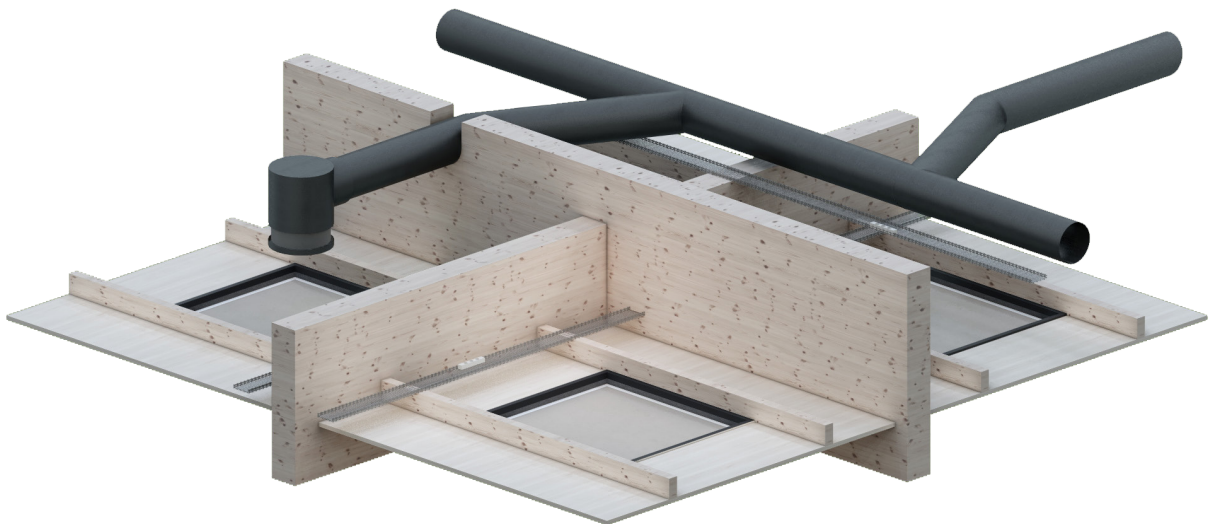

ENERGY CONSIDERATIONS

From the analysis of the energy production and strategies of energy consumption, it was stated that this project would aim for the standard issue of BR18 energy consumption, meaning an energy frame of 41 kWh/m². The design process led to a building proposal containing a large amount of glazing in the facades, and further investigation into the needs of the museum led to natural ventilation being unpreferred due to draft, influence on exhibition, and the activation of the roofscape. This led to the implementation of larger ventilation aggregates to assist in increasing the airflow to reduce over temperatures without exposing the exhibition area to pollution or draft. The energy frame of the building is, with danish primary energy factors, 72.8 kWh/m² for heating, cooling, and operational electricity. The building is heated by two IDM Terra AL 60 MAX heat pumps, which also manage to heat the domestic hot water. The ventilation system manages to cool the building during the day hours with volumes based on the carbon dioxide production of people attending the museum. A strategy of ventilating the

building at nighttime to ensure a cool building from the beginning of the use time ensures that no oven temperatures are present in the building. The primary energy factor in Denmark should vary largely from the primary energy factor in Norway. As previously mentioned, 96% of the electricity generated in Norway comes from water plants, where in Denmark, 60% of the produced electricity includes the harvest, transport, and processing of coal, oil, and gas. The primary energy factor of 1.9 means that the factories consume approximately 1.9 kWh to produce 1 kWh for the consumer. In comparison to Norway, where they do not have primary energy factors, this is high. Since Norway produces almost all energy on renewable sources, and the danish primary energy factor fell from 2.5 to 1.9 with the implementation of more renewable sources, it can be assumed that if Norway had a primary energy factor, it would be 1 or even far below that. With the considerations of Norwegian standards in comparison to the museum and the calculated consumption, the actual energy frame would be 38.3 kWh/m² if the primary energy factor is 1, and even better results going towards voluntary low energy building. However, 38.3 kWh/m² is within the standard issue of 41 kWh/m² and is therefore deemed acceptable, when considering alternative primary energy factors (see appendix 4).

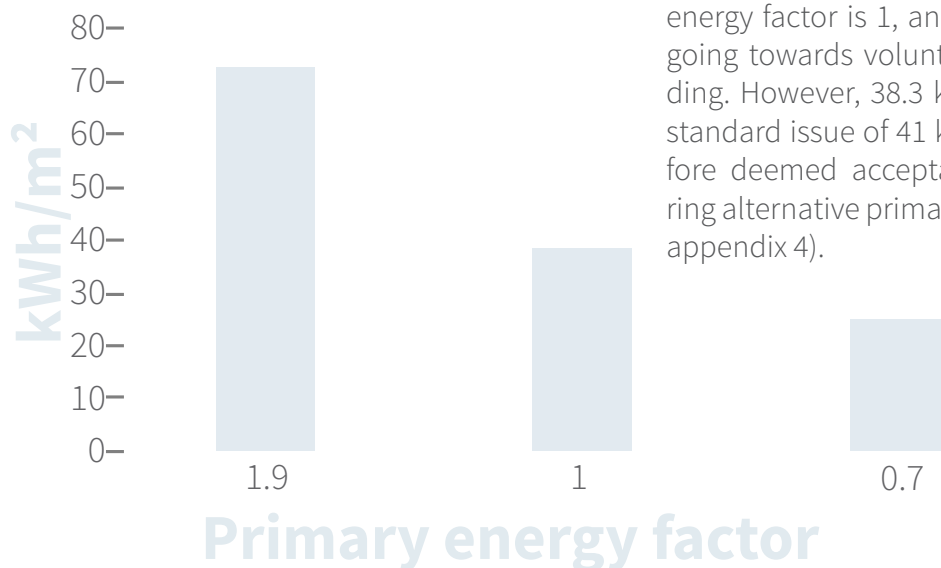

Key numbers kWh/m² pr year

Energyframe BR 18

Without addition	Addition for special conditions	Total energyframe
41.2	0.0	41.2
Total energy requirement		72.8

Energyframe low energy

Without addition	Addition for special conditions	Total energyframe
33.0	0.0	33.0
Total energy requirement		72.8

Addition to energy requirement

Heat	0.0
E. for operation of building	38.3
Excessive heat in rooms	0.0

Net requirement

Room heating	36.6
Domestic hot water	5.3
Cooling	0.0

Selected electricity requirements

Lighting	3.0
Heating of rooms	12.6
Heating of DHW	0.0
Heat pump	10.4
Ventilators	12.4
Pumps	0.0
Cooling	0.0
Total energy consumption	41.0

Heat loss from installations

Room heating	0.0
Domestic hot water	0.0

Output from special sources

Solar heat	0.0
Heat pumps	29.3
Solar cells	0.0
Wind mills	0.0

INDOOR CLIMATE

The Danish Working Environment Authority (TDWEA) recommends different comfort temperatures based on winter or summer. During summer, the comfort temperature is 23-26 degrees, while in winter it is 20-23 degrees. The maximum temperature calculations are performed during summer and ensure that the comfort tempera-

tures are not exceeded when the external solar shading is activated. The operational temperatures are based on winter conditions and ensure that the thermal comfort level is not exceeded either. In conclusion, the thermal indoor climate adheres to the recommendations of TDWEA.

Thermal comfort	Maximum temperatures	Operational temperatures
Single office	24.44 °C	22.25 °C
Leader office	24.91 °C	22.89 °C
4-man office	24.01 °C	22.47 °C
8-man office	24.02 °C	22.31 °C
Meeting room	23.66 °C	22.32 °C

III. 298

TDWEA describes atmospheric comfort as being the movement of air pollutants, avoiding the draft, and ensuring a low energy consumption of the task. The comfort ventilation is based on sensoric loads to ensure a healthy working environment, and this air change rate further supports, that the stationary balance of carbon dioxide is achieved far below the limit of indoor com-

fort class II. The inlets are placed on the floor along the façade and are dimensioned to an extent that ensures draft is not happening. In conclusion, the atmospheric comfort of the office spaces all adhere to the requirements of indoor comfort class II, while also satisfying the requirements of TDWEA

Carbon dioxide concentration	Stationary balance	Airflow
Single office	719.1 ppm	1.43 l/sm ²
Leader office	597.4 ppm	1.07 l/sm ²
4-man office	772.2 ppm	1.67 l/sm ²
8-man office	763.7 ppm	1.62 l/sm ²
Meeting room	887.2 ppm	2.62 l/sm ²

III. 299

In accordance with TDWEA as previously described, the office spaces must adhere to the reverberation sound limit of 0.8s in any given frequency, and this has been sustained without the implementation of additional sound-absorbing elements in the office spaces. Furthermore, is there a requirement of having a floor with low im-

pact sound, which the laminate flooring handles. There is a requirement of establishing meeting areas in informal processes outside the office spaces, which the common area handles. In conclusion, the acoustic indoor climate adheres recommendations of TDWEA.

Reverberation time	125 Hz	250 Hz	500 Hz	1000 Hz	2000 Hz	4000 Hz
Single office	0.28 s	0.31 s	0.42 s	0.37 s	0.57 s	0.54 s
Leader office	0.35 s	0.42 s	0.58 s	0.49 s	0.69 s	0.64 s
4-man office	0.35 s	0.38 s	0.50 s	0.43 s	0.58 s	0.55 s
8-man office	0.48 s	0.51 s	0.65 s	0.50 s	0.63 s	0.59 s
Meeting room	0.34 s	0.36 s	0.43 s	0.37 s	0.46 s	0.44 s

III. 300

TDWEA recommends a 2% daylight factor on the working table. To extend that requirement, DGNB provides the highest score when achieving 3% daylight at 50% of the area. The daylight simulations are done by Velux Daylight Visualizer and are prone to inaccuracies. However, the estimated result indicates a certain frame of reference. The offices all adhere to the requirements of both DGNB and TDWEA. Furthermore, TDWEA requires that there is a minimum of 7m² per employee in the given room, while

also maintaining 12m³ air per employee. The most critical room is the 4-man office with 8.3% daylight at 50% of the working area. This indicates too much light, but the same simulation shows the inconveniences of developing narrow and long spaces. The narrow room requires a large window opening to ensure the back of the room is naturally lit. The overall large dimensions on the windows are to ensure a certain degree of daylight can enter the central room (see appendix 5).

Daylight factor	Average daylight	Average daylight at 50 % area
Single office	3.5 %	5.5%
Leader office	4.0 %	5.5 %
4-man office	4.4 %	8.3 %
8-man office	2.2 %	3.0 %
Meeting room	2.3 %	3.3 %

III. 301

DAYLIGHT ANALYSIS

The daylight factors indicate certain lighting conditions in the various spaces. The narrative thought to guide the visitors in a subconscious journey is one of the three-act structures, contextually known as the “home-out-home” principle. The journey begins for the visitors in a slightly lit area, traveling through passages and getting glimpses of the light from the northern facade in between the exhibition walls. The western facade contains large glass panels and acts as beacons along the journey, creating a path for the visitor to follow until they reach the unknown in the central exhibition space. The central exhibition space is a controlled space with less than 1% daylight, this represents the chaos of the three-act structure, and this is where the visitor is faced with the dilemmas and subjects the exhibition revolves around, and finally, along the southern part of the multiroom, the visitor finishes their journey in bright light, having attained new knowledge and evolved from their previous person. The visitor then comes home to the same area the journey began in, allowing for contemplation and consideration within the restaurant, the book shop, or within the urban area.

Spatial dimensions and their influence on glass panel sizing

A building with a depth of 30 meters brings with it some challenges in terms of creating favorable daylight conditions in the middle. In this case, the book shop and information required the facades to contain large glass panels to create an adequate daylight factor of 2%. In addition to this, the transparency of the project is increased with the increased glass area. The daylight factor along the northern facade is immensely large at 17% according to Velux Daylight Visualizer, but the northern light is diffuse, and will therefore never create a glare.



III. 302

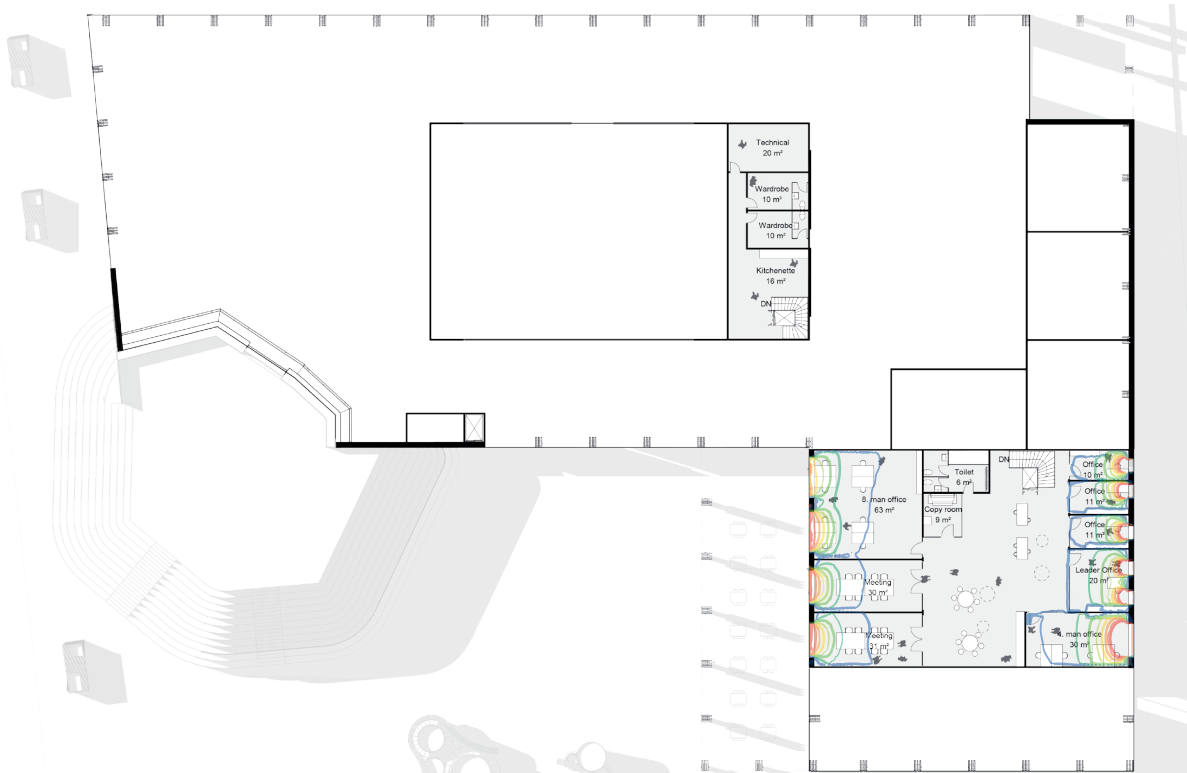

III. 303

VENTILATION

The ventilation principle is that of displacement ventilation, with stack buoyancy as its driving force. The cool inlet air enters the room through spaced openings in the floor along the facade. The temperature of the air influences the density, making the cool air heavier, and thereby forces existing warmer air to rise towards the buoyant zone. The inlet air mixes with existing air at the occupational zone, decreasing the pollution of the space and thereby increasing the atmospheric comfort.

The inlet armatures have piping running in the upper layer of EPS insulation. The pipes are connected to displacement boxes, which in turn are connected to the primary piping, which is connected to the ventilation shaft in the southern section of the building. The exhaust armatures are placed in the double-spanning beam layer at the roof. They must be here in order to efficiently utilize buoyancy.

The inlet is dimensioned from recommendations of the producer, Nilfisk, to avoid the draft in the occupational zone with the required air change.

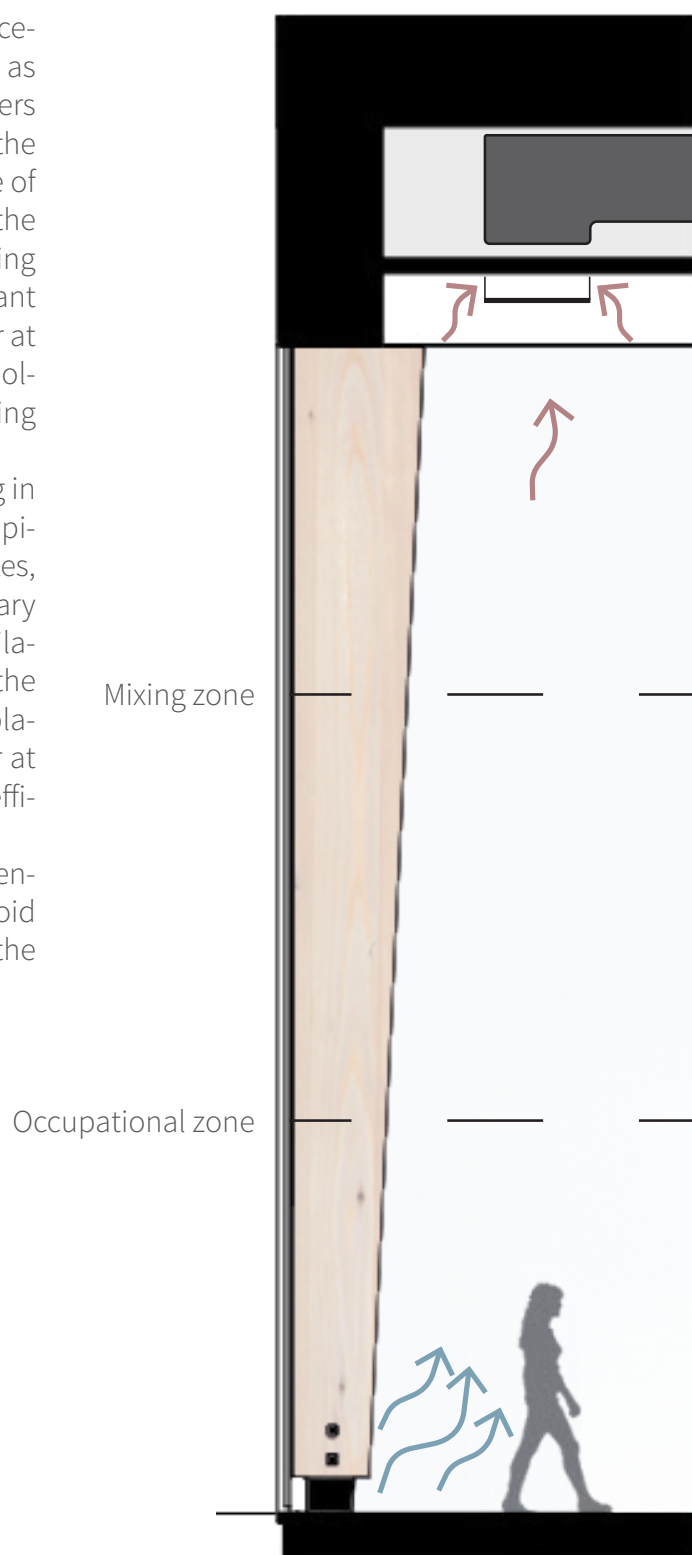

FIRE STRATEGY

The construction system is solely built from wooden elements. The external forces required the material to be Glulam with 30 MPa strength. The benefit of having glulam in contrast to regular construction wood is that the residue used to bind the elements together increases the fire resistance of the material to a R60 certification, which is adequate to be qualified as a category 2 approved material.

Wooden elements as dense as CLT and Glulam also provide an internal fire resistance due to the char layer generated when exposed to fire. The outer section of the material will char to a degree that prevents fire and heat from penetrating further. To consider this, the section has

been corrugated with a factor that reduces the section by 30%, so that even in a fire present for 60 minutes, the construction will not fail.

In addition to the proofing of the material, all areas of passage are a minimum of 1.3 meters wide in accordance with the danish building regulation, as well as having openings in the facade with an opening width of a minimum of 1.5 meters.

The building will not be sprinkled due to the fire resistance of the materials, but rather have an ABA (automatisk brandalarmerings anlæg) installed, which contacts the local fire department and provides plans and strategies to be implemented in order to extinguish the fire.

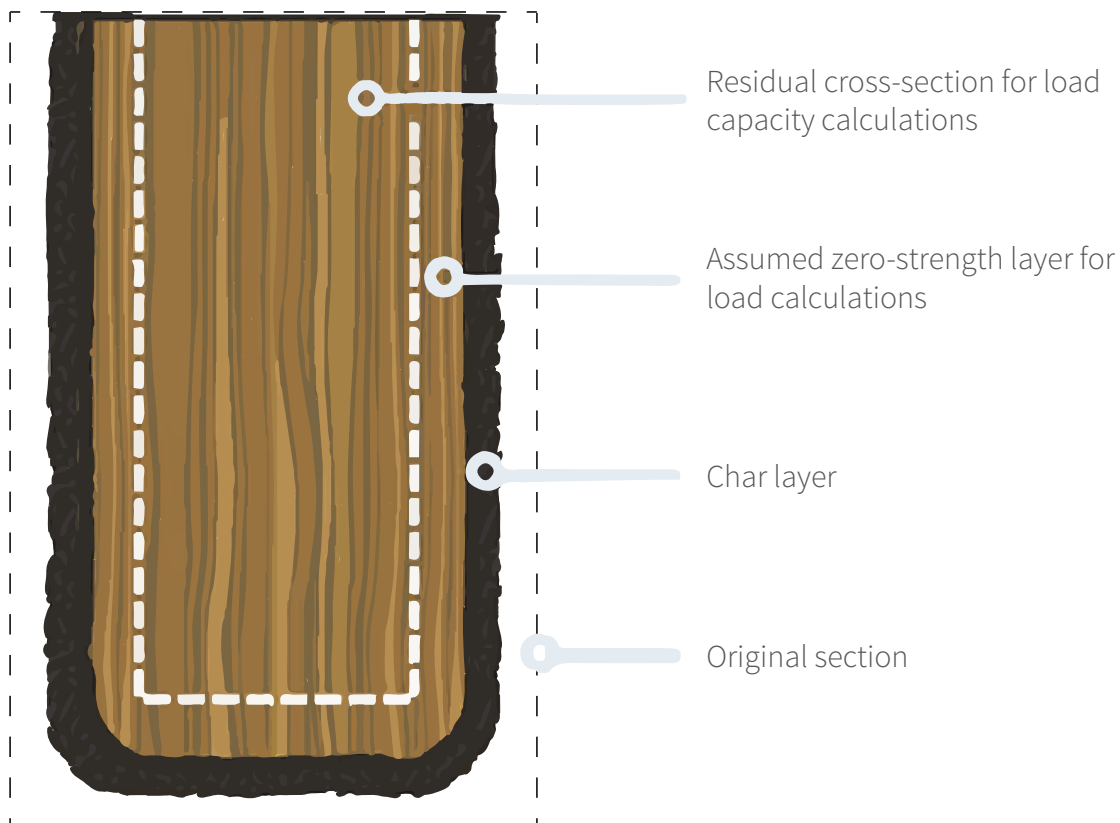

III. 305

DGNB CERTIFICATION

As a stable of sustainable development, the DGNB certification is considered one of the most esteemed in Denmark. As an introduction to this project development, the structure of DGNB was explained, alongside a goal of achieving silver certification as a minimum. In order to score the developed proposal, a certain set of sub-criteria defined by each of the six major topics has to be met and evaluated. The points have been awarded based on discussions within the sub-categories of DGNB, and since some categories are impossible to get points in without actually developing foreman strategies, a potential score is also provided. The discussions and scoring led to a combined score of 56.49 %, with the individual subjects scoring:

Environmental	56.86%
Economy	51.81%
Social	66.32%
Technical	65.50%
Process	21.68%
Site	70.00%

And a potential score of 70.37% with especially the process being a huge difference in the finalized certification.

In conclusion, the intensively low process scoring makes it unable to get a certification at all. However, the remaining indicators suggest that the building is well suited for a silver certification at the current state. The silver certification requires an overall score of 50% with 35% in each sub-category. Furthermore, under the circumstance that the building has to be built, the potential capabilities of the building indicate a low gold certificate. Assumably the building will have the sustainable potential of somewhere in between silver and gold certificates.

DGNB heart certification

A new parameter in DGNB 2020 is the heart certification which indicates a certain indoor climate condition based on regular DGNB validations. This contains an expanded focus on air quality, acoustics, visual conditions, and thermal indoor climate. The users of the building must be in focus with the possibility of manual control on the many facets of indoor climate. With the DGNB heart certificate, the building proves its robustness.

After attempted contact with the headquarters of DGNB Denmark, the verdict was that the student matrix has not been updated to 2020 standards with the DGNB heart certificate, and they were not permitted to send me a copy of the matrix developed for DGNB consultants. However unfortunate the situation is, the DGNB heart could not be certified (see appendix 6).

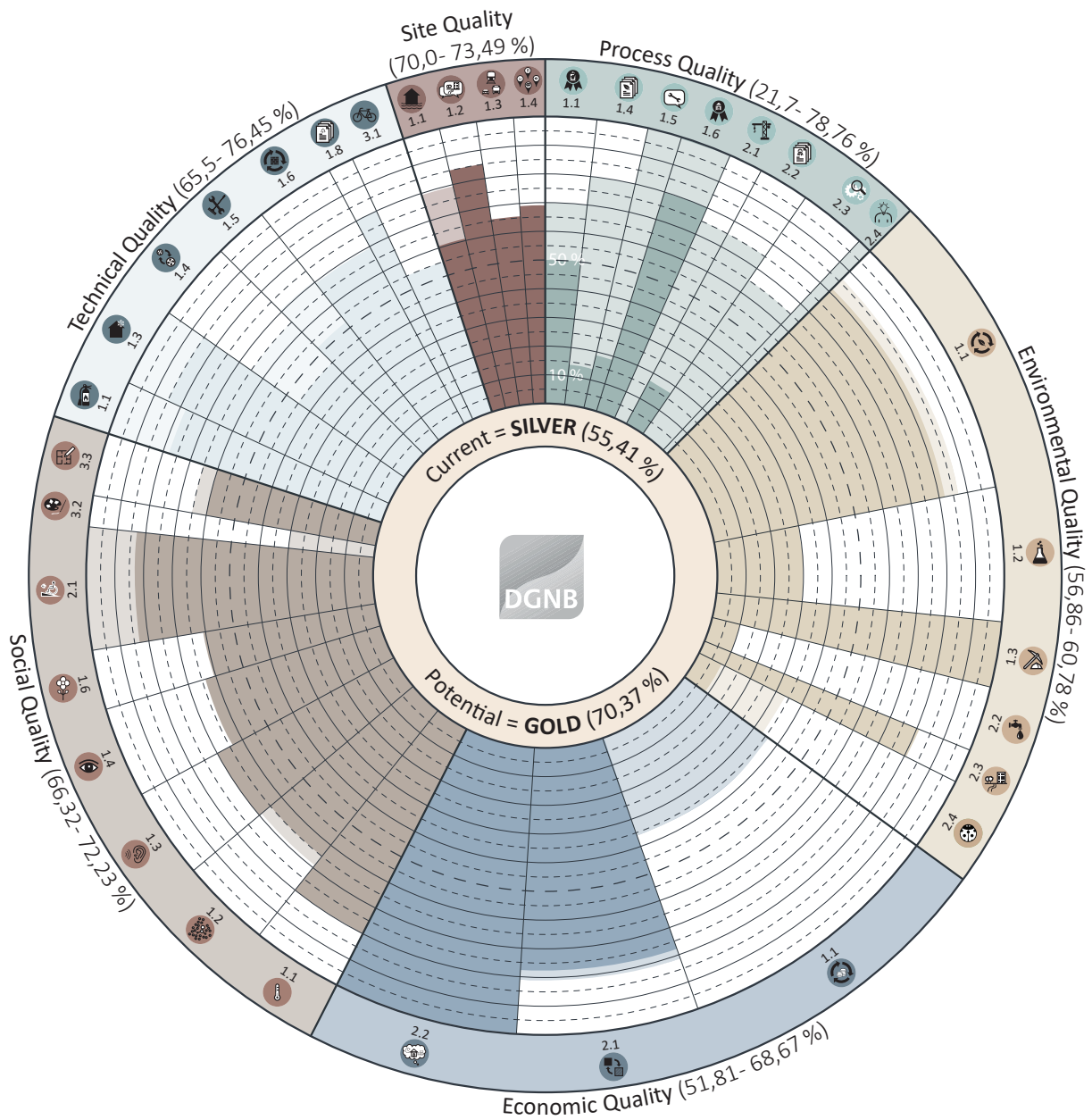

LCA RESULTS

To validate the environmental profile of the building, a thorough LCA has been converged for the entire building including operational factors. This building is then put against the reference values of DGNB to identify a score in terms of certifying the building with DGNB.

The reference values of DGNB are quite high, as the exemplary building in LCA-byg, which is an office building filled to the brim with concrete, mineral wool, bricks, and steel, can score what is equal to 40-50 points in the DGNB criteria. The House of Photography building largely consists of wooden elements through cladding, insulation, construction, and joints. The wooden element will, in contrast to the hard elements of the exemplary building, store carbon dioxide during its growth as mentioned previously in the report. This indicates that the GWP of the House of Photography will be significantly lower, and the remaining factors reflect the reduced impact wood has on the environment.

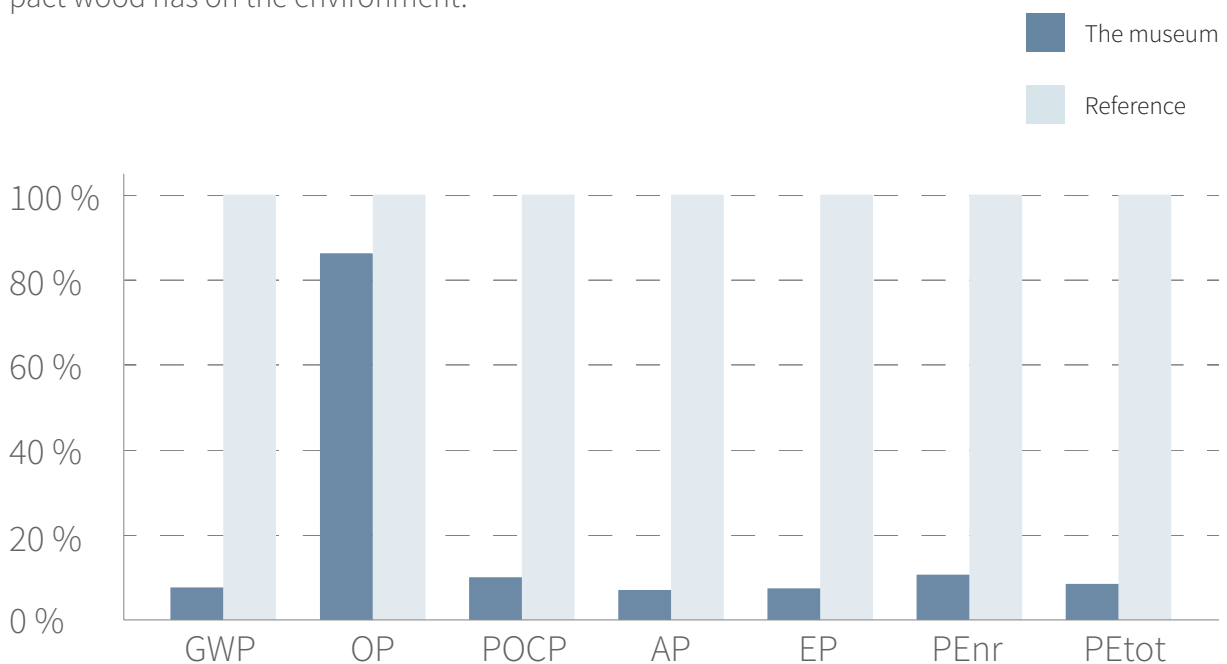

III. 307

Indicator point	10	50	100	Weight	Points
GWP	1.4 R_GWP	1 R_GWP	0.7 R_GWP	40%	40
ODP	10 R_ODP	1 R_ODP	0.7 R_ODP	15%	10.9
POCP	2 R_POCP	1 R_POCP	0.7 R_POCP	15%	15
AP	1.7 R_AP	1 R_AP	0.7 R_AP	15%	15
EP	2 R_EP	1 R_EP	0.7 R_EP	15%	15

III. 308

Indicator	Unit	The museum	Reference
GWP	Kg CO ₂ eq	7.65	100
ODP	Kg CFC11-eq	86.33	100
POCP	Kg ethene-eq	10.1	100
AP	Kg SO ₂ eq	6.95	100
EP	kg PO ₄ ³⁻ eq	7.45	100
PE _{nr}	Kg Sb-eq	10.57	100
PE _{tot}	MJ	8.41	100

III. 309

Total DGNB 2.1 score

95.9

05

RECAPITULATION

CONCLUSION

The project finds footing in the notion of widespread cultural influence on society. The building emanates debate, discussion, and socially relevant topics in its function as well as its architecture, and in a low and wide expression, blurs the membrane of envelopes and creates the possibility of social interaction from internal- to exterior spaces.

The vision of the project revolved largely around challenging the elitary perception of the museum as an institution. The designed project faces this notion by bringing art, exhibition, and opinions into eye level and includes a large variety of user groups. Transparency is a key descriptive additive for the building, which is contrary to the traditional museum typology, but assists in creating social interaction and altering the elitary perception.

The structural layout of the buildings ensures a high degree of future flexibility in terms of repurposing the building, and the strategies of designing for disassembly further allows for future dismantlement and resettlement. The large constructive spans influence the spatial interpretation and create a resolute harmony and sense of stability.

The museum is functionally organized in a way that allows for enlightenment, entertainment, and education of multiple user groups through workshops, activity rooms, lectures, and exposure to exhibitions and discussions. The educational benefit is thought to teach the visitors to be critical when exposed to media, as well as enlightening visitors of socially relevant topics on a human scale. The ceiling height in the exhibition spaces allows for large-scale prints which influence the way art is perceived and interpreted.

Conclusively, sustainability is a primary driver in terms of material choices and technical strategies that depend on Norway's renewable energy production. This led to reduced envelope thickness and overall reduced material consumption in combination with increased operational electricity consumed. This in turn meant that the danish energy frame would not be upheld. However, in a Norwegian context, the chosen strategies are justified.

REFLECTION

Covid-19 and its influence

During the development of this master's thesis, the world is facing the pandemic of Covid-19. This in turn massively influenced the way the project could be developed, through its limitations in terms of physical attendance, analogue communication through modeling, and manifold and physical supervision. In addition to the micro-scale influence on the design process, the macro scale was largely influenced as well. Our project site is in Oslo, Norway, which has been off-limits since the beginning of the project, which means that the developed project bears the mark of us not being able to make on-site analyses and sketches. The atmosphere of a place, identifying the genius loci, and standing there in the middle of the context usually add immense value to the conceptual development. In this case, the atmospheric and phenomenological explorations had to be substituted with cartographic and 3D digital explorations.

Transparency

The competition material and the vision of the organization require a large degree of transparency in the building. This includes the exhibition halls and activity rooms. This demand led to a design process led by compromises. The ideal exhibition space requires fully controllable conditions in terms of acoustics, light, and temperature, and the implementation of large amounts of glass to satisfy the demand for transparency led to uncontrollable parameters.

Scale and contextual relation

The programmed scale of the museum induced some difficulties in terms of establishing a contextual relation with the pylons of cultural significance in close proximity. The Oslo Opera and the Edward Munch museum reach heights of 42 and 55 meters respectively and areas consisting of 38,500 and 26,300 m² respectively. To construct an additional cultural element into this context, with a building programmed at 10 meters height and 4000 m² area, required alternative design strategies. The sheer difference in scale made us consider that the contextual relation had to be one of building low and wide and activating the roofscapes to be focus points that communicate with the surrounding buildings. The building had to get its character and status from something that wasn't based on height.

LITERATURE LIST

3xn.com, n.d. Sydney fish market. Available at: <<https://3xn.com/project/sydney-fish-market>> [Accessed 7 February 2021].

Aarstiderne.dk, n.d. Den Blå Kant. Available at: <<https://aarstiderne.dk/cases/den-blaa-kant/>> [Accessed 7 February 2021].

Ahmad, S., 2014. Museum Exhibition Design: Communication Of Meaning And The Shaping Of Knowledge. 1st ed. Sabah: Elsevier Ltd, pp.255-259. Available at: <<https://www.sciencedirect.com/science/article/pii/S1877042814055013>> [Accessed 06 February 2021].

Attia, S. and Ibrahim, A., 2017. Accessible and Inclusive Public Space: The Regeneration of Waterfront in Informal Areas. *Urban Research & Practice*, 11(4), pp.314-337.

Betonelement-foreningen, 2020. EPD-Vægge. 1st ed.p.6

Bygningsreglementet.dk, 2021. BR18. Available at: <<https://bygningsreglementet.dk/Ovrige-bestemmelser/25/Krav>> [Accessed 2 February 2021].

Bygren, L., Konlaan, B. and Johansson, S., 1996. Attendance at cultural events, reading books or periodicals, and making music or singing in a choir as determinants for survival: Swedish interview survey of living conditions. *BMJ*, 313(7072), pp.1577-1580.

Dansk Standard, 2001. DS/CR 1752. 1st ed. Charlottenlund.

Dansk Standard, 2003. Akustik - Måling af lydabsorption i efterklangsrum. 1st ed. Charlottenlund.

Dansk Standard, 2007. DS/EN 15251. 1st ed. Charlottenlund.

DGNB, 2021. Sølv, guld og platin. Available at: <<https://www.dk-gbc.dk/dgnb/certificering/soelv-guld-og-platin/>> [Accessed 9 February 2021].

Fabriksbetonforeningen, 2021. MD-20011-DA_rev1

Fotografihuset, n.d. Vår visjon - Fotografihuset. Fotografihuset. Available at: <<https://fotografihuset.no/var-visjon/>> [Accessed 22 May 2021].

Ginneruparkitekter.dk, n.d. Honnørkajen | Ginneruparkitekter. Available at: <<https://ginneruparkitekter.dk/projekter/honnoerkajen>> [Accessed 7 February 2021].

Give Steel, 2020. MD-20042-EN

Goudal, N., 2016. Interview 2016.

Grodach, C., 2009. Beyond Bilbao: Rethinking Flagship Cultural Development and Planning in Three California Cities. *Journal of Planning Education and Research*, 29(3), pp.353-366.

Gursky, A., 2018. I Pursue One Goal – The Encyclopaedia of Life.

Gulvlageret.dk, n.d. Bambus x-treme® beklædningsbrædder Trapez. gulvlageret.dk. Available at: <<https://gulvlageret.dk/bambus-x-treme-facade-beklaedning-1505/bambus-x-treme-beklaedningsbraedder-trapez-p30193>> [Accessed 3 May 2021].

Haase, D., Kabisch, S., Haase, A. 2017. Greening cities – To be socially inclusive? About the alleged paradox of society and ecology in cities. *Habitat International*, 64, pp.41-48.

Harrouk, C., 2020. Dorte Mandrup Reveals Design for the Wadden Sea World Heritage Center, in Lauwersoog, Netherlands. *ArchDaily*. Available at: <<https://www.archdaily.com/953779/dorte-mandrup-reveals-design-for-the-wadden-sea-world-heritage-center-in-lauwersoog-netherlands>> [Accessed 10 February 2021].

Hellwig, R., 2020. Materiality and Construction of Sustainable Buildings – Lecture 1: Introduction and Assignment.

IEA.a 2020. Coal - Fuels & Technologies - IEA. Available at: <<https://www.iea.org/fuels-and-technologies/coal>> [Accessed 9 February 2021].

IEA.b 2020. Denmark - Countries & Regions - IEA. Available at: <<https://www.iea.org/countries/den>>

mark> [Accessed 2 February 2021].

Jensen, L., 2017. Tårnhøje norske træambitioner - Træ.dk. Træ.dk. Available at: <<https://www.trae.dk/artikel/taarnhoeje-norske-traeambitioner/>> [Accessed 6 February 2021].

Jyllands-Posten, 2018. Økonomien i Dokk1-byggeriet hænger - vist nok - sammen. Available at: <<https://jyllands-posten.dk/jpaarhus/ECE11012229/oekonomien-i-dokk1byggeriet-haenger-vist-nok-sammen/>> [Accessed 6 February 2021].

Kabisch, N., Frantzeskaki, N. and Pauleit, S., 2016. Nature-based solutions to climate change mitigation and adaptation in urban areas: perspectives on indicators, knowledge gaps, barriers, and opportunities for action. *Ecology and Society*, 21(2).

Knudstrup, M., 2004. Integrated Design Process in Problem-Based Learning. Aalborg: Mary-Ann Knudstrup, pp. 4-7. Available at: https://vbn.aau.dk/ws/portalfiles/portal/16081935/IDP_in_PBL_2004_Mary-Ann_Knustrup_Ny_pdf_fil.pdf [Accessed 4 February 2021].

Kulturministeriet, 2019. Den Nationale Brugerundersøgelse. Årsrapport 2018. SLKS. Available at: <<https://slks.dk/omraader/kulturinstitutioner/museer/statistik-om-museer/den-nationale-brugerundersogelse/>> [Accessed 22 November 2020].

Lincoln, A., 2020. How is coronavirus changing our event and exhibition industry? - Admind. Admind. Available at: <<https://admindagency.com/how-is-coronavirus-changing-our-event-and-exhibition-industry-or-taking-our-experiences-from-the-physical-to-the-digital-in-2020-and-beyond/>> [Accessed 18 February 2021].

Lindsey, R., 2021. Climate Change: Global Sea Level | NOAA Climate.gov. [online] Climate.gov. Available at: <<https://www.climate.gov/news-features/understanding-climate/climate-change-global-sea-level>> [Accessed 2 February 2021].

Mason, M., 2021. What Is Sustainability and Why Is It Important? | EnvironmentalScience.org. EnvironmentalScience.org. Available at: <<https://www.environmentalscience.org/sustainability>> [Accessed 9 February 2021].

environmentalscience.org/sustainability> [Accessed 9 February 2021].

Miljøstatus, 2020. Klima - Miljøstatus for Norge. Available at: <<https://miljostatus.miljodirektoratet.no/Tema/Klima/>> [Accessed 2 February 2021].

Nordregio, 2018. Fjord City: A waterfront urban renewal project | Nordregio. Available at: <https://nordregio.org/sustainable_cities/fjordbyen/> [Accessed 2 February 2021].

Nordic Council of Ministers, 2019. Wood in Construction - 25 cases of Nordic Good Practice. Copenhagen: Nordisk Ministerråd, pp.6-9. Available at: <https://issuu.com/nordic_council_of_ministers/docs/2019-010_wood_in_construction-web_n> [Accessed 4 May 2021].

Ny Fillerup Savværk, 2021. Cedertræ - dansk Thuja | Ny Fillerup Savværk, Odder. Available at: <<https://nyfillerupsavvaerk.dk/savvaerket/trae/cedertrae/>> [Accessed 6 February 2021].

Olesen, M. and Tinning, K., 2019. Dansk træbyggeri halter efter udlandet. Wood Supply DK. Available at: <https://www.wood-supply.dk/article/view/658443/dansk_traebyggeri_halter_etter_udlandet> [Accessed 6 February 2021].

Oslo kommune, 2014. S-4807. 1st ed. Oslo: Oslo Kommune, p.All. Available at: <<https://od2.pbe.oslo.kommune.no/kart/#597993,6642087,7>> [Accessed 22 May 2021].

Paqua, M., 2021. Visitor Journey Mapping In Museums. Medium. Available at: <<https://museums-digitalculture.prattsi.org/visitor-journey-mapping-in-museums-f18442ee1d99>> [Accessed 18 March 2021].

Peterson, K., 2017. The power of photography – The Rocky Mountain Collegian. Collegian.com. Available at: <<https://collegian.com/2017/11/the-power-of-photography/>> [Accessed 18 February 2021].

Randers Tegl, 2020 MD-14003-EN. 1st ed. 2020. p.8

Rasmussen, a, S., 1962. Experiencing Architecture

re. 2nd ed. Boston: The M.I.T Press, p.10, 186-214, 224-241.

Rasmussen, b, S., 1962. Experiencing architecture. 2nd ed. Boston: The M.I.T. Press, p.10.

Rasmussen, c, S., 1962. Experiencing architecture. 2nd ed. Boston: The M.I.T. Press, p.189.

Rockwool A/S, 2020 Den lille lune - for byggefagfolk. 1st ed. Hedehusene: p.16.

Shl.dk., n.d. SHL – Commonwealth Pier. Available at: <<https://www.shl.dk/dk/commonwealth-pier/>> [Accessed 7 February 2021].

Shore, S., 2011. Form and pressure. Available at: <<https://www.yumpu.com/en/document/read/44224418/form-and-pressure-2011-pdf-steph-shore>> [Accessed 21 February 2021].

Cubo, n.d. Håndværkskollegiet | Horsens | Cubo. [online] Available at: <<https://cubo.dk/projekt/haandvaerkskollegiet-horsens/>> [Accessed 7 February 2021].

Snohetta.com, n.d. Norwegian National Opera and Ballet. Available at: <<https://snohetta.com/project/42-norwegian-national-opera-and-ballet>> [Accessed 7 February 2021].

Statista, 2021. Norway: electricity production by source 2019 | Statista. Available at: <<https://www.statista.com/statistics/1025497/distribution-of-electricity-production-in-norway-by-source/>> [Accessed 2 February 2021].

Statistisk sentralbyrå, 2020. Kulturstatistikk 2019. ssb.no. Available at: <<https://www.ssb.no/kultur-og-fritid/artikler-og-publikasjoner/kulturstatistikk-2019>> [Accessed 6 February 2021].

Stender, M., 2020. Social Sustainability - How Can We Build It?.

Stern, P. & Hall, P. V. (2018). Greening the waterfront? Submerging history, finding risk, Just Green Enough, ed. Curran and Hamilton, 1st edition, Routledge.

TEDx Talks, 2010. Renée Byer at TEDx Tokyo 2009. Available at: <https://www.youtube.com/watch?v=Z3CDOS4GNdQ&feature=emb_title&ab_channel=TEDxTalks> [Accessed 18 February 2021].

Træ.dk a, 2020. CLT - Konstruktionstræprodukter. 1st ed, p.6.

Træ.dk b, 2016. Thuja (Kæmpethuja) - Træ.dk. Available at: <<https://www.trae.dk/leksikon/thuja-kaempethuja/>> [Accessed 6 February 2021].

Træ.dk c. 2020. MD-20005-EN

Umberson, D. and Montez, J., 2010. Social Relationships And Health: A Flashpoint For Health Policy. Austin, Texas: American Sociological Association. Available at: <<https://www.ncbi.nlm.nih.gov/pmc/articles/PMC3150158/>> [Accessed 22 November 2020].

Visit Norway, n.d. Tag på en grøn getaway til Oslo. Visitnorway.dk. Available at: <<https://www.visitnorway.dk/rejsemal/ostlandet/oslo/green-getaway/>> [Accessed 18 April 2021].

Visitnorway.dk, n.d. En introduktion til arkitektur i Norge. Available at: <<https://www.visitnorway.dk/aktiviteter/kunst-kultur/arkitektur/en-introduktion/>> [Accessed 6 February 2021].

Visit Oslo, 2021. Oslo - europæisk miljøhovedstad 2019 - visitnorway.dk. Visitnorway.dk. Available at: <https://www.visitnorway.dk/rejsemal/ostlandet/oslo/?_ga=2.17040817.980770810.1612454128-987481974.1612454128> [Accessed 4 February 2021].

Yeung, T., 2013. Epistemological Realism: The major distinction between Photography and Painting. Medium. Available at: <<https://medium.com/photography-tips/epistemological-realism-the-major-distinction-between-photography-and-painting-45ad305677c7>> [Accessed 17 February 2021].

ILLUSTRATION LIST

Ill. 1-8: Own illustrations

Ill. 9: Fotografihuset, 2021. Vår visjon. Available at: <<https://fotografihuset.no/var-visjon/>> [Accessed 23 May 2021].

Ill. 10: Fotografihuset, 2021. Vår visjon. Available at: <<https://fotografihuset.no/var-visjon/>> [Accessed 23 May 2021].

Ill. 11: Noemie Goudal, n.d. Fotokunst. Available at: <<https://likeellebelle.wordpress.com/2010/09/11/noemie-goudal-fotokunst/>> [Accessed 23 May 2021].

Ill. 12: Gursky, A., n.d. Paris, Montparnasse. Available at: <<https://www.bbc.com/culture/article/20151106-andreas-gursky-the-bigger-the-better>> [Accessed 23 May 2021].

Ill. 13: PixlArt, n.d. Exhibition during Covid-19. Available at: <<https://xn--stvendssysselofkeblad-pfc.dk/flere-smaa-royale-lys-i-vintermoerket/>> [Accessed 23 May 2021].

Ill. 14: N+P, 2021. Nordic architecture. Available at: <<https://www.pinterest.dk/pin/817333032375836632/>> [Accessed 23 May 2021].

Ill. 15: Hjørshøj, R., 2021. Available at: <<https://www.pinterest.dk/pin/817333032375746854/>> [Accessed 23 May 2021].

Ill. 16: n.d. Home design. Available at: <<https://www.pinterest.dk/pin/817333032375747283/>> [Accessed 23 May 2021].

Ill. 17: n.d. House in snow. Available at: <<https://www.pinterest.dk/pin/477311260479214328/>> [Accessed 23 May 2021].

Ill. 18: n.d. Housings. Available at: <<https://www.pinterest.dk/pin/817333032375747549/>> [Accessed 23 May 2021].

Ill. 19: n.d. Available at: <<https://www.pinterest.dk/pin/817333032375746878/>> [Accessed 23 May 2021].

Ill. 20: n.d. Wood cladding. Available at: <<https://www.pinterest.co.uk/pin/321092648436137912/>> [Accessed 23 May 2021].

Ill. 21-25: Own Illustrations

Ill. 26: Johansen, G., 2021. The new Munch museum. Available at: <<https://www.lonelyplanet.com/articles/new-munch-museum-oslo>> [Accessed 23 May 2021].

Ill. 27: Malde, A., 2021. The opera. Available at: <<https://www.globalcitizen.org/es/content/how-cities-are-fighting-climate-change/>> [Accessed 23 May 2021].

Ill. 28: Aslaksen, E., 2021. Deichman Bjørvika. Available at: <<https://www.fremtidensbygg.no/disse-11-design-og-arkitekturprosjektene-er-nominert-til-hederspris/>> [Accessed 23 May 2021].

Ill. 29: 2021. Oslo Skyscrapers. Available at: <<https://pixy.org/36710/>> [Accessed 23 May 2021].

Ill. 30: Borgen, Ø., n.d. Bjørvika. Available at: <<https://www.aftenposten.no/oslo/i/rjL60/slik-er-formuen-delt-i-oslo-sjekk-ditt-nabolag>> [Accessed 23 May 2021].

Ill. 31: Own Illustration

Ill. 32: Visit Oslo, 2021. Sørenga. Available at: <<https://www.visitoslo.com/fr/produit/?TLp=1238140>> [Accessed 23 May 2021].

Ill. 33: n.d. Bjørvika residents. Available at: <<https://rfix.eu/tehtud-tood/munch-brygge-klaaspiirded/>> [Accessed 23 May 2021].

Ill. 34: Archipanic, n.d. Munch museum. Available at: <<https://www.pinterest.es/pin/382665299593129281/>> [Accessed 23 May 2021].

Ill. 35: n.d. Havnelageret. Available at: <https://no.tripadvisor.com/Attraction_Review-g190479-d17629220-Reviews-Havnelageret-Oslo_Eastern_Norway.html> [Accessed 23 May 2021].

Ill. 36: Klugmann, C., n.d. The Oslo Opera House - Norway. Available at: <<http://www.christianklugmann.com/#/oslo-opera-norway/>> [Accessed 23 May 2021].

Ill. 37: n.d. Royal Palace. Available at: <<https://aker-posten.no/dagen-i-dag/fra/226/29.1.15>> [Accessed 23 May 2021].

Ill. 38: n.d. Oslo Botanical Garden. Available at: <<https://br.pinterest.com/pin/481955597620872738/>> [Accessed 23 May 2021].

Ill. 39: n.d. Ekeberg skulpturpark. Available at: <https://www.visitoslo.com/es/actividades-y-atracciones/zonas/oslo-este/atracciones/?_escaped_fragment_=Page,4> [Accessed 23 May 2021].

Ill. 40- 44: Own illustrations

Ill. 45: n.d. Hiroshima. Available at: <<https://ifworlddesignguide.com/entry/231689-the-east-building-of-the-hiroshima-peace-memorial-museum>> [Accessed 23 May 2021].

Ill. 46: n.d. Hiroshima 2. Available at: <<http://www.hiroshimapeacemedia.jp/?p=91406>> [Accessed 23 May 2021].

Ill. 47: n.d. Chichu Art Museum. Available at: <<https://www.pinterest.dk/pin/297167275409749644/>> [Accessed 23 May 2021].

Ill. 48: 2021. House interior. Available at: <<https://www.pinterest.com.au/pin/490822059383920036/>> [Accessed 23 May 2021].

Ill. 49: Architectural Digest, 2021. House. Available at: <<https://www.pinterest.dk/pin/333477547417163133/>> [Accessed 23 May 2021].

Ill. 50-52: Own illustrations

Ill. 53: ArchDaily, n.d. Wooden interior. Available at: <<https://www.pinterest.cl/pin/64950419602805935/>> [Accessed 23 May 2021].

Ill. 54: n.d. Mjøstårne. Available at: <<https://www.dezeen.com/2019/03/19/mjostarne-worlds-tallest-timber-tower-voll-arkitekter-norway/>> [Accessed 23 May 2021].

Ill. 55- 68: Own Illustrations

Ill. 69: PixlArt, 2018. PixlArt exhibition. Available at:

<<https://www.tv2nord.dk/frederikshavn/pixlart-rykker-ind-pa-den-store-scene>> [Accessed 24 May 2021].

Ill. 70: PixlArt, n.d. PixlArt. Available at: <<https://xn--stvendssselfolkeblad-pfc.dk/supertravl-sommer-hos-pixlart/>> [Accessed 24 May 2021].

Ill. 71: PixlArt, n.d. PixlArt. Available at: <<https://www.pixlart.nu/kontakt/>> [Accessed 24 May 2021].

Ill. 72: PixlArt, n.d. PixlArt office. Available at: <<https://realdania.dk/projekter/pixlart>> [Accessed 24 May 2021].

Ill. 73: PixlArt, n.d. Outdoor Exhibition. Available at: <<https://www.pixlart.nu/kontakt/>> [Accessed 24 May 2021].

Ill. 74: PixlArt, 2021. PixlArt education. Available at: <<https://www.facebook.com/pixlart.dk/photos/2836317993288827>> [Accessed 24 May 2021].

Ill. 75: Visit Berlin, 2021. C/O Berlin. Available at: <<https://www.visitberlin.de/it/co-berlin>> [Accessed 24 May 2021].

Ill. 76: C/O Berlin, 2021. C/O Berlin. Available at: <<https://www.smow.com/blog/2015/11/anton-corbijn-hollands-deep-1-2-3-4-co-berlin/anton-corbijn-hollands-deep-1-2-3-4-c-o-berlin-03/>> [Accessed 24 May 2021].

Ill. 77: Foam, n.d. Available at: <<https://www.foam.org/nl/talent/foam-en-talent>> [Accessed 24 May 2021].

Ill. 78: Foam, n.d. Available at: <<https://artpil.com/news/mirroring-life-andre-kertesz/>> [Accessed 24 May 2021].

Ill. 79: Fotografiska, n.d. Fotografiska. Available at: <<https://www.pinterest.se/pin/535928424390605239/>> [Accessed 24 May 2021].

Ill. 80: n.d. Fotografiska. Available at: <<https://www.pinterest.se/pin/394065036126022778/>> [Accessed 24 May 2021].

Ill. 81: Jeu de Paume, 2016. Jeu de Paume. Avail-

lable at: <<http://moussmagazine.it/uprisings-jeu-de-paume-paris/>> [Accessed 24 May 2021].

Ill. 82: Jeu de Paume, 2016. Jeu de Paume. Available at: <<http://moussmagazine.it/uprisings-jeu-de-paume-paris/>> [Accessed 24 May 2021].

Ill. 83: Henning Larsen, 2021. Moesgaard Museum. [image] Available at: <<https://www.skyfish.com/p/henninglarsenarchitects/601481?predicate=created&direction=desc>> [Accessed 25 May 2021].

Ill. 84: Henning Larsen, 2021. Moesgaard Museum. [image] Available at: <<https://www.skyfish.com/p/henninglarsenarchitects/601481?predicate=created&direction=desc>> [Accessed 25 May 2021].

Ill. 85: Henning Larsen, 2021. Moesgaard Museum. [image] Available at: <<https://www.skyfish.com/p/henninglarsenarchitects/601481?predicate=created&direction=desc>> [Accessed 25 May 2021].

Ill. 86: n.d. Oslo opera. Available at: <<https://in.pinterest.com/pin/37956907483988808/>> [Accessed 24 May 2021].

Ill. 87: Snøhetta, n.d. The Oslo opera. Available at: <<https://snohetta.com/project/42-norwegian-national-opera-and-ballet>> [Accessed 24 May 2021].

Ill. 88: Snøhetta, n.d. The Oslo opera. Available at: <<https://snohetta.com/project/42-norwegian-national-opera-and-ballet>> [Accessed 24 May 2021].

Ill. 89: Cubo, 2020. Håndværkerkollegiet. Available at: <<https://cubo.dk/projekt/haandvaerkerkollegiet-horsens/>> [Accessed 24 May 2021].

Ill. 90: Cubo, 2020. Håndværkerkollegiet. Available at: <<https://cubo.dk/projekt/haandvaerkerkollegiet-horsens/>> [Accessed 24 May 2021].

Ill. 91: Årstiderne Arkitekter/Sweco Architects, 2020. Den blå kant. Available at: <<https://aarstiderne.dk/cases/den-blaa-kant/>> [Accessed 24 May 2021].

Ill. 92: Årstiderne Arkitekter/Sweco Architects, 2020. Den blå kant. Available at: <<https://aarstiderne.dk/cases/den-blaa-kant/>> [Accessed 24 May 2021].

Ill. 93-103: Own illustrations

Ill. 104: Olivier Navarro, 2021. Beach service. Available at: <<https://www.pinterest.dk/pin/817333032375273996/>> [Accessed 24 May 2021].

Ill. 105: KNSTRCT, n.d. Beach passage. Available at: <<https://www.pinterest.nz/pin/373306256608155526/>> [Accessed 24 May 2021].

Ill. 106: n.d. Outdoor Exhibition. Available at: <<https://www.pinterest.co.uk/pin/377176537519292639/>> [Accessed 24 May 2021].

Ill. 107: Behance, n.d. Exhibition. Available at: <<https://www.pinterest.dk/pin/551620654365040493/>> [Accessed 24 May 2021].

Ill. 108: ArchDaily, n.d. Available at: <https://www.archdaily.com/511780/tamarama-kiosk-lahznimmo-architects/53893bb0c07a-805cea000030-tamarama-kiosk-lahznimmo-architects-photo?next_project=no> [Accessed 24 May 2021].

Ill. 109: n.d. Beach cafe. Available at: <<https://bestcoffeeshopdesign.blogspot.com/2020/08/beach-cafe-interior.html>> [Accessed 24 May 2021].

Ill. 110: n.d. Shop. Available at: <<https://www.pinterest.dk/pin/145944844164718453/>> [Accessed 24 May 2021].

Ill. 111: Reggiani Illuminazione, n.d. Entrance. Available at: <<https://www.pinterest.dk/pin/817333032375242055/>> [Accessed 24 May 2021].

Ill. 112: n.d. Information. Available at: <[https://www.pinterest.co.kr/pin/416934877995335297/?amp_client_id=CLIENT_ID\(&mweb_unauth_id=&from_amp_pin_page=true](https://www.pinterest.co.kr/pin/416934877995335297/?amp_client_id=CLIENT_ID(&mweb_unauth_id=&from_amp_pin_page=true)> [Accessed 24 May 2021].

Ill. 113: Interior Design, 2021. Foyer. Available at: <<https://www.pinterest.dk/pin/817333032375242145/>> [Accessed 24 May 2021].

Ill. 114: ArchDaily, n.d. Wooden foyer.

Available at: <<https://www.pinterest.dk/pin/817333032370094002/>> [Accessed 24 May 2021].

Ill. 115: Jonathan Lowes, n.d. Thesis Instigation. Available at: <<https://www.pinterest.dk/pin/817333032373368429/>> [Accessed 24 May 2021].

Ill. 116: n.d. Exhibition. Available at: <<https://www.pinterest.dk/pin/1093952565705479761/>> [Accessed 24 May 2021].

Ill. 117: Marolt, J., 2017. light pyramids adorn black box theater. Available at: <<https://www.designboom.com/architecture/kosi-in-partnerji-black-box-theater-slovenia-06-13-2019/>> [Accessed 24 May 2021].

Ill. 118: BBP Arkitekter, 2021. Kay Fisker hal. Available at: <<https://www.bbp.dk/projektbeskrivelse-69>> [Accessed 24 May 2021].

Ill. 119: n.d. Dark exhibition. Available at: <<https://www.pinterest.dk/pin/341992165437326268/>> [Accessed 24 May 2021].

Ill. 120: Cesar, E., n.d. Exhibition. Available at: <<https://www.archdaily.com.br/br/927594/sala-de-exposicoes-do-instituto-cervantes-em-brasilia-sainz-arquitetura/5dba8d163312fd7c7e00055f-sala-de-exposicoes-do-instituto-cervantes-em-brasilia-sainz-arquitetura-foto>> [Accessed 24 May 2021].

Ill. 121: Laterza, P., n.d. Office. Available at: <<https://www.archilovers.com/projects/243784/ondatel.html>> [Accessed 24 May 2021].

Ill. 122: n.d. Exhibitions. Available at: <<https://www.pinterest.dk/pin/817333032375768722/>> [Accessed 24 May 2021].

Ill. 123: n.d. Urban garden. Available at: <<https://www.pinterest.dk/pin/817333032375982927/>> [Accessed 24 May 2021].

Ill. 124: SPLANN, 2020. Available at: <<http://splann.fr/>> [Accessed 24 May 2021].

Ill. 125: n.d. Bench. Available at: <<https://wisont.wordpress.com/2016/01/11/the-deck-phuket/>>

<[the-deck-phuket-63/](https://wisont.wordpress.com/2016/01/11/the-deck-phuket/)> [Accessed 24 May 2021].

Ill. 126-309: Own illustrations

06

APPENDIX

NOAA CHART OF SEA LEVEL RISE

APPENDIX 1

Possible future sea levels for different greenhouse gas pathways

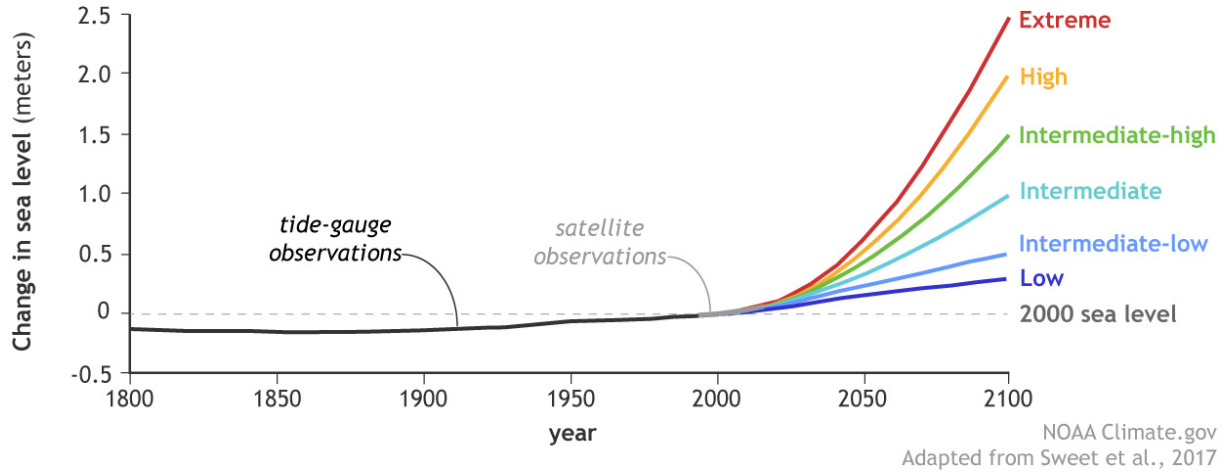

CONSTRUCTION CALCULATIONS FOR LCA INVESTIGATION

APPENDIX 2

LCA - Material comparison conditions

A simple deck supported by beams:

Span dimensions:

4000 x 8000 mm

C/C distance: 4000 mm

Deck load imposed: 1 kN/m²

Usage load: 1,5 kN/m²

Combined: 2,5 kN/m²

Material dependant conditions:

Wood:

Beam dimensions: 150 x 400 mm

GL30C

Strength 18,6 MPa

Load: 3,76 kN = 0,47 kN/m

Combined load: 8,47 kN/m

Concrete:

Beam dimensions: 200 x 400 mm

C25

Strength: 18 MPa

Load: 18 kN = 2,2 kN/m

Combined load: 10,2 kN/m

Steel:

Beam dimensions: IPE 600

S235

Strength: 122,5 MPa

Load: 7kN = 0,9 kN/m

Combined load: 8,7 kN/m

Maximum momentum:

$$\text{Wood: } \frac{1}{8} \cdot 8,47 \cdot (8)^2 = 67,76 \cdot 10^6 \text{ Nmm}$$

$$\text{Concrete: } \frac{1}{8} \cdot 10,2 \cdot 8^2 = 81,6 \cdot 10^6 \text{ Nmm}$$

$$\text{Steel: } \frac{1}{8} \cdot 8,7 \cdot 8^2 = 69,6 \cdot 10^6 \text{ Nmm}$$

Opposing momentum:

$$\text{Wood: } \frac{1}{6} \cdot 150 \cdot 400^2 = 4 \cdot 10^6$$

$$\text{Concrete: } \frac{1}{6} \cdot 200 \cdot 400^2 = 5,3 \cdot 10^6$$

$$\text{Steel: } 6,57 \cdot 10^5$$

Tension:

$$\text{Wood: } \frac{67,76 \cdot 10^6}{4 \cdot 10^6} = 17 \text{ MPa} < 18,6 \text{ MPa}$$

$$\text{Concrete: } \frac{81,6 \cdot 10^6}{5,3 \cdot 10^6} = 15,4 \text{ MPa} < 18 \text{ MPa}$$

$$\text{Steel: } \frac{69,6 \cdot 10^6}{6,57 \cdot 10^5} = 106 < 122,5$$

Material used per beam

$$\text{Wood: } 0,15 \cdot 0,4 \cdot 8 = 0,48 \text{ m}^3$$

$$\text{Concrete: } 0,2 \cdot 0,4 \cdot 8 = 0,64 \text{ m}^3$$

$$\text{Steel: } (0,562 \cdot 0,012 + 2 \cdot 0,22 \cdot 0,019) \cdot 8 = 0,12 \text{ m}^3$$

Weight:

$$\text{Wood: } 0,48 \cdot 470 = 0,225 \text{ T}$$

$$\text{Concrete: } 0,64 \cdot 2240 = 1,43 \text{ T}$$

$$\text{Steel: } 0,12 \cdot 7850 = 0,942 \text{ T}$$

The factor of concrete must be lowered by 60% due to the addition of arming steel.

In relation:

$$\text{Wood: } 0,48 \cdot \text{EPD(m}^3\text{)}$$

$$\text{Concrete: } 0,3 \cdot \text{EPD(m}^3\text{)}$$

$$\text{Steel: } 0,94 \cdot \text{EPD(T)}$$

CONSTRUCTION CALCULATIONS

APPENDIX 3

Upper layer of beams:

Width: 100 mm

Height: 2000 mm

Density: 430 kg/m³

Length: 73 meters, supported every fourth.

C/C: 4 meters

Calc. strength: 18.4 MPa from Teknisk Ståbi

Roof: 1.7 kN/m² imposed load.

Beam: 3,44 kN / 4m imposed load.

RoofRel: 27,2 kN/ 4m

Perm:

$$1 \cdot \frac{3,44}{4} + 1,2 \cdot \frac{27,2}{4} = 9 \text{ kN/m}$$

Variable:

$$(1,5 \cdot 1 + 1 \cdot 1) \frac{27,2}{4} = 17 \text{ kN/m}$$

Strength:

Maximum momentum:

$$\frac{1}{8} \cdot \left(9 \frac{\text{kN}}{\text{m}} + 17 \frac{\text{kN}}{\text{m}} \right) \cdot (4\text{m})^2 = 52 \cdot 10^6 \text{ Nmm}$$

Opposing momentum:

$$\frac{1}{6} \cdot 100\text{mm} \cdot (2000\text{mm})^2 = 6,67 \cdot 10^7 \text{ mm}^3$$

Tension:

$$\sigma = \frac{52 \cdot 10^6 \text{ Nmm}}{6,67 \cdot 10^7 \text{ mm}^3} = 0,8 \text{ MPa}$$

Lower layer of beams:

Width: 300 mm

Height: 1500 mm

Density: 430 kg/m³

Length: 30 meters.

C/C: 4 meters

Calc. strength: 18.4 MPa from Teknisk Ståbi

Roof: 1.7 kN/m² imposed load.

Beam: 58,05 kN

RoofRel + imposed upper layer: 228 kN

Perm:

$$1 \cdot \frac{58,05}{30} + 1,2 \cdot \frac{228}{30} = 11 \frac{kN}{m}$$

Variable:

$$(1,5 \cdot 1 + 1 \cdot 1) \frac{228,08}{30} = 19 \frac{kN}{m}$$

Strength:

Maximum momentum:

$$\frac{9}{128} \cdot \left(11 \frac{kN}{m} + 19 \frac{kN}{m} \right) \cdot (30m)^2 = 1,9 \cdot 10^9 Nmm$$

Opposing momentum:

$$\frac{1}{6} \cdot 300mm \cdot (1500mm)^2 = 1,125 \cdot 10^8 mm^3$$

Tension:

$$\sigma = \frac{1,9 \cdot 10^9 Nmm}{1,125 \cdot 10^8 mm^3} = 16,9 MPa$$

Static check:

$$16,9 MPa < 18,4 MPa$$

Columns in the facade:

Central section width: 100 mm

Central section depth: 500 mm

Material: GL30c

Density: 430 kg/m³

Imposed load from beams: 450 kN, divided into three for each sheet.

Tension:

$$\sigma = \frac{150,324 \cdot 10^3 N}{(100 \cdot 500)} = 3 MPa$$

Slimness

$$f_{cd} = 0,444 \cdot 30 = 13,3 MPa$$

$$\lambda_y = \frac{8000mm}{\sqrt{\frac{1}{12} \cdot 100mm \cdot (500mm)^3}} = 55,4$$

$$\lambda_{rel,y} = \frac{55,4}{\pi} \cdot \sqrt{\frac{13,3MPa}{11100MPa}} = 0,61$$

$$k_y = 0,5 \cdot (1 + 0,2(0,61 - 0,3) + 0,61^2) = 0,72$$

$$k_{cy} = \frac{1}{0,72 + \sqrt{0,72^2 - 0,61^2}} = 0,91$$

$$1 > \frac{3 MPa}{0,91 \cdot 13,3 MPa} = 0,25$$

BE18 CUTOUTS

APPENDIX 4

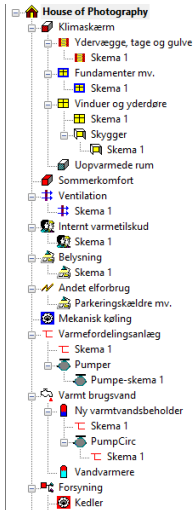

Bygning
 Navn: House of Photography

Andet: Friliggende bolig (friliggende enfamiliehus)
 Sammenbyggede boliger (fx dobbel-, række- og kædehuse)
 Etagebolig, Lager mv eller Andet (ikke bolig)

1: Antal boligenheder
 4500: Opvarmet etageareal, m²
 600: Opvarmet kælder, m²
 3316: Bebygget areal, m²
 83: Varmekapacitet, Wh/K m²
 63: Normal brugstid, timer/uge
 10: Rotation, °
 4800: Bruttoareal, m²
 19: Start, kl.
 19: Slut, kl.

Beregningsbetingelser
 BR: Aktuelle i Se beregningsvejledningen

Tilæg til energivarmen for særlige betingelser, kWh/m² år

Kun muligt for andre bygninger end boliger og beregningsbetingelser:
 BR: Aktuelle forhold.
 OBS: Ny reference for belysning i BR15: 300 lux.

Varmeforsyning
 Basis: Kedel, Fjernvarme, Blokvarme eller El

Varmefordelingslæg (hvis elvarme)

Bidrag fra (i prioritets-orden)

1. Elradatorer 2. Brændeovne, gasstrålevarmere og lgn.
 3. Solvarme 4. Varmepumpe 5. Solceller 6. Vindmøller

Mekanisk køling
 Andel af etageareal, -

Samlet varmetab
 Transmissionstab 81,8 kW 17,3 W/m²
 Ventilationstab uden vgv 257,7 kW 54,4 W/m² (om vinteren)
 I alt 339,5 kW 71,6 W/m²
 Ventilationstab med vgv 20,6 kW 4,3 W/m² (om vinteren)
 I alt 102,4 kW 21,6 W/m²

Transmissionstabsramme
 Almindelig 16,3 W/m²
 Lavenergi 15,3 W/m²

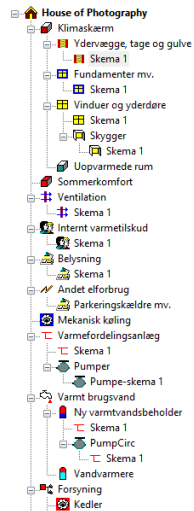

	Ydervægge, tage og gulve	Areal (m ²)	U (W/m ² K)	b	Ht (W/K)	Dim.Inde (C)	Dim.Ude (C)	Tab (W)
		9435,8		CtrlClick	1842,73			50352,2
+1	North facade envelope	155	0,15	1,00	23,25			744
2	East facade envelope	190	0,15	1,00	28,5			912
3	South facade envelope	220	0,15	1,00	33			1056
4	West facade envelope	210	0,15	1,00	31,5			1008
5	North glazing CLIMAPLUS XN KRYPTON	575	0,6	1,00	345			11040
6	East glazing	290	0,6	1,00	174			5568
7	South glazing	360	0,6	1,00	216			6912
8	West glazing	260	0,6	1,00	156			4992
9	North window	0	0,6	1,00	0			0
10	East window	27	0,6	1,00	16,2			518,4
11	South window	0	0,6	1,00	0			0
12	West window	32,8	0,6	1,00	19,68			629,76
13	Roof	3400	0,12	1,00	408			13056
14	Terrain	3316	0,1	1,00	331,6		10	3316
15	Basement wall north	100	0,15	1,00	15		10	150
16	Basement wall east	100	0,15	1,00	15		10	150
17	Basement wall south	100	0,15	1,00	15		10	150
18	Basement wall west	100	0,15	1,00	15		10	150
19								
20								

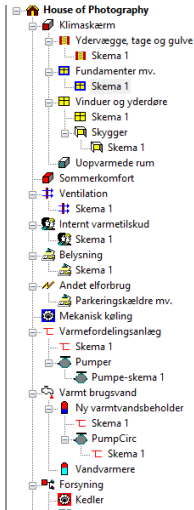

	Fundamenter og samlinger ved vinduer	l (m)	Tab (W/mK)	b	Ht (W/K)	Dim.Inde (C)	Dim.Ude (C)	Tab (W)
		704,2		CtrlClick	55,042			1761,34
+1	Windows north	0	0,03	1,00	0			0
2	Glazing north	77,4	0,03	1,00	2.322			74.304
3	Foundation north	77,4	0,12	1,00	9.288			297.216
4	Roof north	77,4	0,03	1,00	2.322			74.304
5	Door north	0	0,03	1,00	0			0
6	Windows east	22	0,03	1,00	0,66			21,12
7	Windows South	0	0,03	1,00	0			0
8	Windows West	0	0,03	1,00	0			0
9	Glazing east	40	0,03	1,00	1,2			38,4
10	Glazing south	47	0,03	1,00	1,41			45,12
11	Glazing west	16	0,03	1,00	0,48			15,36
12	Foundation east	56	0,12	1,00	6,72			215,04
13	Foundation south	50	0,12	1,00	6			192
14	Foundation west	48	0,12	1,00	5,76			184,32
15	Roof east	65	0,1	1,00	6,5			208
16	Roof south	60	0,1	1,00	6			192
17	Roof west	62	0,1	1,00	6,2			198,4
18	Door east	6	0,03	1,00	0,18			5,76
19	Door south	0	0,03	1,00	0			0
20	Door west	0	0,03	1,00	0			0

House of Photography

- Klimaskærm
 - Ydervægge, tage og gulve
 - Skema 1
 - Fundamenter mv.
 - Skema 1
 - Vinduer og yderdøre
 - Skema 1
 - Skygger
 - Skema 1
 - Uopvarmede rum
 - Sommerkomfort
 - Ventilation
 - Skema 1
 - Internt varmetilskud
 - Skema 1
 - Belysning
 - Skema 1
 - Andet elforbrug
 - Parkeringskældre mv.
 - Mekanisk køling
 - Varmefordelingsanlæg
 - Skema 1
 - Pumper
 - Pumpe-skema 1
 - Varmt brugsvand
 - Ny varmtvandsbeholder
 - Skema 1
 - PumpCirc
 - Skema 1
 - Vandvarmere
 - Forsyning
 - Kedler

	Vinduer og yderdøre	Antal	Orient	Hældn.	Areal (m²)	U (W/m²K)	b	Ht (WK)	Ff (-)	g (-)	Skygger	Fc (-)	Dim.Indi	Dim.Ude	Tab (W)	Ot
		12			1546,8		CtrlClick	926,88			CtrlClick				29660,2	0/1
+1	Windows north	1	N	90	0	0,6	1,00	0	0,85	0,54	Opera	1			0	0
2	Glazing north	1	N	90	575	0,6	1,00	345	0,85	0,54	Opera	1			11040	0
3	Door north	1	N	90	0	0	1,00	0	0	0		1			0	0
4	Windows east	1	E	90	27	0,6	1,00	16,2	0,85	0,54	East	1			518,4	0
5	Glazing east	1	E	90	290	0,6	1,00	174	0,85	0,54	East	1			5568	0
6	Door east	1	E	90	2	0	1,00	0	0	0		1			0	0
7	Windows south	1	S	90	0	0,6	1,00	0	0,85	0,54	Sørenga	1			0	0
8	Glazing south	1	S	90	360	0,6	1,00	216	0,85	0,54	Sørenga	1			6912	0
9	Door south	1	S	90	0	0	1,00	0	0	0		1			0	0
10	Windows west	1	W	90	32,8	0,6	1,00	19,68	0,85	0,54	Default	1			629,76	0
11	Glazing west	1	W	90	260	0,6	1,00	156	0,85	0,54	Default	1			4992	0
12	Door west	1	W	90	0	0	1,00	0	0	0		1			0	0
13																
14																
15																
16																
17																
18																
19																
20																

House of Photography

- Klimaskærm
 - Ydervægge, tage og gulve
 - Skema 1
 - Fundamenter mv.
 - Skema 1
 - Vinduer og yderdøre
 - Skema 1
 - Skygger
 - Skema 1
 - Uopvarmede rum
 - Sommerkomfort
 - Ventilation
 - Skema 1
 - Internt varmetilskud
 - Skema 1
 - Belysning
 - Skema 1
 - Andet elforbrug
 - Parkeringskældre mv.
 - Mekanisk køling
 - Varmefordelingsanlæg
 - Skema 1
 - Pumper
 - Pumpe-skema 1
 - Varmt brugsvand
 - Ny varmtvandsbeholder
 - Skema 1
 - PumpCirc
 - Skema 1
 - Vandvarmere
 - Forsyning
 - Kedler

	Skygger	Horisont (°)	Udhaeng (°)	Venstre (°)	Højre (°)	Vindueshul (%)
+1	Opera	25	0	0	60	10
2	Sørenga	15	0	20	0	10
3	East	20	0	60	10	10
4	Default	15	0	0	0	10
5						
6						
7						
8						
9						
10						
11						
12						
13						
14						
15						
16						
17						
18						
19						
20						

House of Photography

- Klimaskærm
 - Ydervægge, tage og gulve
 - Skema 1
 - Fundamenter mv.
 - Skema 1
 - Vinduer og yderdøre
 - Skema 1
 - Skygger
 - Skema 1
 - Uopvarmede rum
 - Sommerkomfort
 - Ventilation
 - Skema 1
 - Internt varmetilskud
 - Skema 1
 - Belysning
 - Skema 1
 - Andet elforbrug
 - Parkeringskældre mv.
 - Mekanisk køling
 - Varmefordelingsanlæg
 - Skema 1
 - Pumper
 - Pumpe-skema 1
 - Varmt brugsvand
 - Ny varmtvandsbeholder
 - Skema 1
 - PumpCirc
 - Skema 1
 - Vandvarmere
 - Forsyning
 - Kedler

	Ventilation	Areal (m²)	Fc, -	qm (l/s m²)	n vg v (-)	ti (°C)	EI-VF	qn (l/s m²)	SEL (kJ/m³)	qm,s (l/s m²)	qn,s (l/s m²)	qm,n (l/s m²)	qn,n (l/s m²)
	Zone	4041		Vinter			0/1	Vinter		Sommer	Sommer	Nat	Nat
+1	Exhibition	1460	0,8	3	0,92	0	0	0	0,13	1,5	3	0	2
2	Offices	365	0,7	2	0,92	0	0	0	0,13	1,5	1	1	2
3	Restaurant	255	0,5	2,3	0,92	0	0	0	0,13	1,5	2,3	0	2
4	Multibox	460	0,5	4,38	0,92	0	0	0	0,13	1,5	4,38	0	2
5	Activity rooms	240	0,5	2,5	0,92	0	0	0	0,13	1,5	2,5	0	2
6	Basement	840	0,15	0	0,92	0	0	0	0	1,5	0	0	2
7	Toilets	71	0,6	1	0,92	0	0	0	0	1,5	1	0	2
8	Kitchen	107	0,7	5	0,92	0	0	0	0	0	0	0	2
9	Exhibition	1460	0,2	0,3	0,92	0	0	0	0,09	1,5	0,3	0	2
10	Offices	365	0,3	0,3	0,92	0	0	0	0,09	1,5	0,3	0	2
11	Restaurant	255	0,5	0,3	0,92	0	0	0	0,09	1,5	0,3	0	2
12	Multibox	460	0,5	0,3	0,92	0	0	0	0,09	1,5	0,3	0	2
13	Activity rooms	240	0,5	0,3	0,92	0	0	0	0,09	1,5	0,3	0	2
14	Basement	840	0,85	0,3	0,92	0	0	0	0	1,5	0,3	0	2
15	Toilets	71	0,4	0,3	0,92	0	0	0	0	1,5	0,3	0	2
16	Kitchen	107	0,3	2	0,92	0	0	0	0	1,5	2	0	2
17	Lager	55	1	0,3	0,92	0	0	0	0	1,5	0,3	0	2
18	Information, meeting, book etc.	470	0	3	0,92	0	0	0	0,13	1,5	3	0	2
19	Information, meeting, book etc.	470	0,4	0,3	0,92	0	0	0	0,09	1,5	0,3	0	2
20		0	0	0	0	0	0	0	0	0	0	2	0

- House of Photography
 - Klimaskærm
 - Ydervægge, tage og gulve
 - Skema 1
 - Fundamenter mv.
 - Skema 1
 - Vinduer og yderdøre
 - Skema 1
 - Skygger
 - Skema 1
 - Uopvarmede rum
 - Sommerkomfort
 - Ventilation
 - Skema 1
 - Internt varmetilskud
 - Skema 1
 - Belysning
 - Skema 1
 - Andet elforbrug
 - Parkeringskældre mv.
 - Mekanisk køling
 - Varmefordelingsanlæg
 - Skema 1
 - Pumper
 - Pumpe-skema 1
 - Varmt brugsvand
 - Ny varmtvandsbeholder
 - Skema 1
 - PumpCirc
 - Skema 1
 - Vandvarmere
 - Forsyning
 - Kedler

Internt varmetilskud	Areal (m²)	Personer (W/m²)	App. (W/m²)	App.nat (W/m²)
Zone	4050,0	6075,0 W	3955,0 W	0,0 W
+1 People in exhibition/foyer/info/bookshop	1930	1,5	0,5	0
2 People in multiroom	460	1,5	0	0
3 People in activity rooms	240	1,5	0,5	0
4 People in offices	365	1,5	1	0
5 People in restaurant	255	1,5	1	0
6 Technical room heat development	700	1,5	2,5	0
7	0	0	0	0
8 Kitchen additional heat	100	1,5	5	0
9	0	1,5	3,5	0
10				
11				
12				
13				
14				
15				
16				
17				
18				
19				
20				

- House of Photography
 - Klimaskærm
 - Ydervægge, tage og gulve
 - Skema 1
 - Fundamenter mv.
 - Skema 1
 - Vinduer og yderdøre
 - Skema 1
 - Skygger
 - Skema 1
 - Uopvarmede rum
 - Sommerkomfort
 - Ventilation
 - Skema 1
 - Internt varmetilskud
 - Skema 1
 - Belysning
 - Skema 1
 - Andet elforbrug
 - Parkeringskældre mv.
 - Mekanisk køling
 - Varmefordelingsanlæg
 - Skema 1
 - Pumper
 - Pumpe-skema 1
 - Varmt brugsvand
 - Ny varmtvandsbeholder
 - Skema 1
 - PumpCirc
 - Skema 1
 - Vandvarmere
 - Forsyning
 - Kedler

Belysning	Areal (m²)	Almen (Win)	Almen (Inst)	Belys. (lux)	DF (%)	Styring (U, M, J, M, A, K)	Fo (-)	Arb. (W/m²)	Andet (W/m)	Stand-by (W)	Nat (W/m²)
Belysningszone	3300										
+1 Exhibition	1480	0	2	200	0	M	1	0	0	0	0
2 Multiroom	370	0	2,5	200	0	M	0,3	0	0	0	0
3 Offices	230	0	4,3	200	3	M	0,8	0	0	0	0
4 Activity room	240	0	4,3	200	3	M	0,5	0	0	0	0
5 Restaurant	210	0	4,3	200	3	M	0,5	0	0	0	0
6 Toilets	120	0	0,5	200	0	M	1	0	0	0	0
7 Basement	650	0	2	200	0	M	0,2	0	0	0	0
8											
9											
10											
11											
12											
13											
14											
15											
16											
17											
18											
19											
20											

- House of Photography
 - Klimaskærm
 - Ydervægge, tage og gulve
 - Skema 1
 - Fundamenter mv.
 - Skema 1
 - Vinduer og yderdøre
 - Skema 1
 - Skygger
 - Skema 1
 - Uopvarmede rum
 - Sommerkomfort
 - Ventilation
 - Skema 1
 - Internt varmetilskud
 - Skema 1
 - Belysning
 - Skema 1
 - Andet elforbrug
 - Parkeringskældre mv.
 - Mekanisk køling
 - Varmefordelingsanlæg
 - Skema 1
 - Pumper
 - Pumpe-skema 1
 - Varmt brugsvand
 - Ny varmtvandsbeholder
 - Skema 1
 - PumpCirc
 - Skema 1
 - Vandvarmere
 - Forsyning
 - Kedler

Beskrivelse:

Varmtvandsforbrug (vand af 55 °C, koldt vand 10 °C)

Gennemsnit for bygningen, liter/år pr. m²-etageareal

Brugsvandsystem

Varmt brugsvand temperatur, °C

Tilføj en varmtvandsbeholder ved højreklik på Varmt brugsvand i oversigten til venstre

House of Photography

- ◻ Klimaskærm
 - ◻ Ydervægge, tage og gulve
 - ◻ Skema 1
 - ◻ Fundamenter mv.
 - ◻ Skema 1
 - ◻ Vinduer og yderværelse
 - ◻ Skema 1
 - ◻ Skygger
 - ◻ Skema 1
 - ◻ Uopvarmede rum
 - ◻ Sommerkomfort
 - ◻ Ventilation
 - ◻ Skema 1
 - ◻ Internt varmetilskud
 - ◻ Skema 1
 - ◻ Belysning
 - ◻ Skema 1
 - ◻ Andet elforbrug
 - ◻ Parkeringskældre mv.
 - ◻ Mekanisk køling
 - ◻ Varmefordelingsanlæg
 - ◻ Skema 1
 - ◻ Pumper
 - ◻ Pumpe-skema 1
 - ◻ Varmt brugsvand
 - ◻ Ny varmtvandsbeholder
 - ◻ Skema 1
 - ◻ PumpCirc
 - ◻ Skema 1
 - ◻ Vandvarmere
 - ◻ Forsyning
 - ◻ Kedler
 - ◻ Fjernvarmeveksler
 - ◻ Anden rumopvarmning

Varmtvandsbeholder

Beskrivelse:

2 Antal beholdere 1 Andel af varmtvandsforbrug, -

1500 Beholdervolumen, liter (For solvarmebeholdere opgives totalvolumen)

55 Fremløbstemperatur fra centralvarme, °C

Nej El-opvarmning af VBV (Hvis 'Nej' kører kedlen om sommeren)

Solvarmebeholder med varmespiral i top. (Korrektion for temp lagdeling)

0 Varmetab fra varmtvandsbeholder, W/K

0 Temperaturfaktor, b for opstillingsrum, - (Opv. zone: b = 0, Ude: b = 1)

Ladepumpe

For kombi-pumpe angives Effekt til 0 W Effekt, W Styret Lade-eff. kW

- ◻ Skema 1
- ◻ Uopvarmede rum
- ◻ Sommerkomfort
- ◻ Ventilation
 - ◻ Skema 1
- ◻ Internt varmetilskud
 - ◻ Skema 1
- ◻ Belysning
 - ◻ Skema 1
- ◻ Andet elforbrug
 - ◻ Parkeringskældre mv.
- ◻ Mekanisk køling
 - ◻ Varmefordelingsanlæg
 - ◻ Skema 1
 - ◻ Pumper
 - ◻ Pumpe-skema 1
- ◻ Varmt brugsvand
 - ◻ Ny varmtvandsbeholder
 - ◻ Skema 1
 - ◻ PumpCirc
 - ◻ Skema 1
 - ◻ Vandvarmere
- ◻ Forsyning
 - ◻ Kedler
 - ◻ Fjernvarmeveksler
 - ◻ Anden rumopvarmning
 - ◻ Solvarmeanlæg
 - ◻ Varmepumper
 - ◻ Luft/vand Varmepumpe IDM Te
 - ◻ Luft/vand Varmepumpe IDM Te
 - ◻ Solceller
 - ◻ Vindmøller
 - ◻ Resultater
 - ◻ Nøgletal
 - ◻ Varmebehov

Beskrivelse:

Varmepumpe Funktion Andel af etageareal, - Varmtvarmtvandsbeholder

Kombineret 1 Volumen 3000 liter

Rumopvarmning VBV

53,6 <input type="text"/>	54,2 <input type="text"/>	Nominal effekt, kW
3,55 <input type="text"/>	4 <input type="text"/>	Nominal COP, -, Inklusive pumper, ventilatorer og automatik
1 <input type="text"/>	0 <input type="text"/>	Rel. COP ved 50% last, -

Test-temperaturer, °C

2 <input type="text"/>	7 <input type="text"/>	Kold side
35 <input type="text"/>	55 <input type="text"/>	Varm side

Udeluft Udeluft

Varmeanlæg

0 0

10,12 0

Kold side: Jordslange, Aftræk, Udeluft eller Anden kilde

Varm side: Rumluft, Indblæsning eller Varmeanlæg

Særligt hjælpeudstyr, W, som ikke er med i nominal COP

Automatik, stand-by, W, (konstant drift)

Temp. virk.grad for vgv før VP, -

Dim. indblæsningstemperatur, °C

Luftstrøm, m³/s

0 0

0 0,09

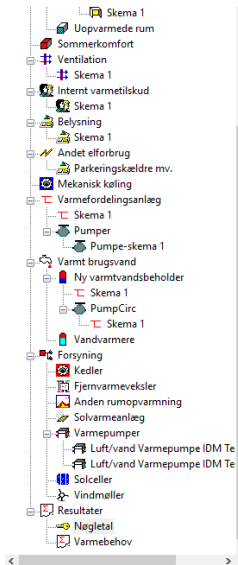

Nøgletal, kWh/m² år

Renoveringsklasse 2			
Uden tillæg	Tilæg for særlige betingelser	Samlet energigramme	
95,5	0,0	95,5	
Samlet energibehov 72,8			
Renoveringsklasse 1			
Uden tillæg	Tilæg for særlige betingelser	Samlet energigramme	
71,6	0,0	71,6	
Samlet energibehov 72,8			
Energigramme BR 2018			
Uden tillæg	Tilæg for særlige betingelser	Samlet energigramme	
41,2	0,0	41,2	
Samlet energibehov 72,8			
Energigramme lavenergi			
Uden tillæg	Tilæg for særlige betingelser	Samlet energigramme	
33,0	0,0	33,0	
Samlet energibehov 72,8			
Bidrag til energibehovet		Netto behov	
Varme	0,0	Rumopvarmning 26,6	
El til bygningsdrift	38,3	Varmt brugsvand 5,3	
Overtemp. i rum	0,0	Køling 0,0	
Udvalgte elbehov		Varmetab fra installationer	
Belysning	3,0	Rumopvarmning 0,0	
Opvarmning af rum	12,6	Varmt brugsvand 0,0	
Opvarmning af vvb	-0,0		
Varmepumpe	10,4	Ydelse fra særlige kilder	
Ventilatorer	12,4	Solvarme 0,0	
Pumper	0,0	Varmepumpe 29,3	
Køling	0,0	Solceller 0,0	
Totalt elforbrug	41,0	Vindmøller 0,0	

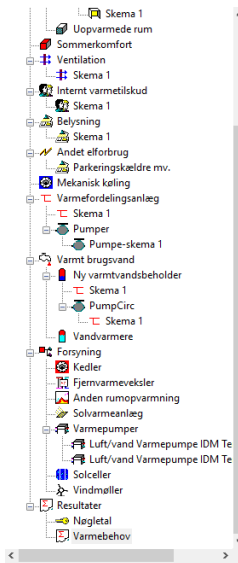

MWh	Januar	Februar	Marts	April	Maj	Juni	Juli	August	September	Oktober	November	December	I alt
Varmebehov													
+1 Trans.- og vent.tab	47,83	43,72	51,32	30,89	21,03	13,82	5,49	5,25	13,07	25,29	39,80	47,83	345,33
2 Vent. VF (total)	0,00	0,00	0,00	0,00	0,00	0,00	0,00	0,00	0,00	0,00	0,00	0,00	0,00
3 Vent. VGV nedreg.	0,00	0,00	0,00	0,00	0,00	0,00	0,00	0,00	0,00	0,00	0,00	0,00	0,00
4 Varmetab	47,83	43,72	51,32	30,89	21,03	13,82	5,49	5,25	13,07	25,29	39,80	47,83	345,33
5 Solindfald	4,81	10,61	24,61	34,52	40,28	37,81	41,00	37,63	29,33	17,84	6,52	3,81	288,77
6 Internt tilskud	4,28	3,77	3,95	3,77	3,85	3,72	3,85	3,90	3,83	4,12	4,14	4,28	47,46
7 Fra rør og VVB konst.	0,00	0,00	0,00	0,00	0,00	0,00	0,00	0,00	0,00	0,00	0,00	0,00	0,00
8 Samlet tilskud	9,09	14,38	28,56	38,30	44,13	41,54	44,85	41,53	33,16	21,95	10,66	8,09	336,24
9 Rel. tilskud. -	0,19	0,33	0,56	1,24	2,10	3,01	8,16	7,92	2,54	0,87	0,27	0,17	
10 Del af rumopv.	1,00	1,00	1,00	0,68	0,00	0,00	0,00	0,00	0,00	0,82	1,00	1,00	
11 Variabl. varmetilsk.	0,00	0,00	0,00	0,00	0,00	0,00	0,00	0,00	0,00	0,00	0,00	0,00	0,00
12 Tot. tilskud	9,09	14,38	28,56	38,30	44,13	41,54	44,85	41,53	33,16	21,95	10,66	8,09	336,24
13 Rel. tilskud. -	0,19	0,33	0,56	1,24	2,10	3,01	8,16	7,92	2,54	0,87	0,27	0,17	
14 Udnyt. faktor	0,99	0,96	0,88	0,63	0,43	0,32	0,12	0,13	0,37	0,76	0,97	0,99	
15 Varmebehov	38,85	29,94	26,09	4,50	0,00	0,00	0,00	0,00	6,97	29,43	39,81	175,59	
16 Vent. VF (centralvarme)	0,00	0,00	0,00	0,00	0,00	0,00	0,00	0,00	0,00	0,00	0,00	0,00	0,00
17 I alt	38,85	29,94	26,09	4,50	0,00	0,00	0,00	0,00	6,97	29,43	39,81	175,59	

INDOOR CLIMATE CALCULATIONS

APPENDIX 5

Comfort ventilation:

Ventilation conditions can be based on sensoric perception or carbon dioxide pollution. Sensoric will generally generate a larger air change, and is the most commonly used in smaller area such as offices.

Sensoric load example:

$$q = 1olf \cdot n + 0,1 \frac{olf}{m^2} \cdot A$$

8-man office:

$$q = 1olf \cdot 8 + 0,1 \frac{olf}{m^2} \cdot 63m^2 = 14,3olf$$

$$V_{is} = \frac{14,3olf}{1,4} \cdot 10 = 102 \frac{l}{s} = 0,102 \frac{m^3}{s}$$

Comfort ventilation	8-man office	Single office	Leader office	Meeting room	4-man office
Flow of air	$0,102 \frac{m^3}{s}$	$0,014 \frac{m^3}{s}$	$0,021 \frac{m^3}{s}$	$0,078 \frac{m^3}{s}$	$0,05 \frac{m^3}{s}$

Maximum temperatures:

A calculation will be done to investigate the temperatures within the rooms, on the condition of solely ventilating for comfort and without external solar shading.

Maximum temp	8-man office	Single office	Leader office	Meeting room	4-man office
Proposal 1	25,81°C	30,22°C	34,51°C	25,37°C	25,85°C
Proposal 2	26,55°C	31,13°C	36,97°C	25,97°C	26,60°C
Proposal 3	26,55°C	31,13°C	35,51°C	25,61°C	28,79°C
Proposal 4	27,28°C	31,13°C	36,97°C	25,97°C	28,79°C
Proposal 5	27,28°C	32,45°C	36,97°C	25,97°C	27,35°C
Proposal 6	27,28°C	29,29°C	36,97°C	25,97°C	27,35°C

Calculation example, repetitive calculations are not shown.

Example: 8-man office proposal 4,5,6.

Transmission loss:

$$B_t = \sum U \cdot A$$

$$B_t = 0,15 \frac{W}{m^2 \cdot ^\circ C} \cdot 34m^2 + 0,6 \frac{W}{m^2 \cdot ^\circ C} \cdot 16,8m^2 + 0,1 \frac{W}{m^2 \cdot ^\circ C} \cdot 63m^2 = 21,5 \frac{W}{^\circ C}$$

$$B_i = 1,2 \frac{kg}{m^3} \cdot 1005 \frac{J}{kg \cdot ^\circ C} \cdot V_i$$

$$B_i = 1,2 \frac{kg}{m^3} \cdot 1005 \frac{J}{kg \cdot ^\circ C} \cdot 0,102 \frac{m^3}{s} = 123 \frac{W}{^\circ C}$$

$$\phi_s = 0,53 \cdot 0,8 \cdot 0,9 \cdot 0,7 \cdot 0,8 \cdot 172 \cdot 16,8 = 617,5W$$

$$\phi_i = 1,5 \frac{W}{m^2} \cdot 63m^2 + 0,5 \frac{W}{m^2} \cdot 63m^2 + 0,3 \frac{W}{m^2} \cdot 63m^2 = 145W$$

$$t_{avg} = 20,5^\circ C + \frac{617,5W + 145W}{21,5 \frac{W}{^\circ C} + 123 \frac{W}{^\circ C}} = 25,78^\circ C$$

$$B_a = 8 \frac{W}{^\circ C \cdot m^2} \cdot 63m^2 = 504 \frac{W}{^\circ C}$$

$$\Delta\phi_{k1} = \frac{2}{3} \cdot (617,5W + 145W - 0) = 508W$$

$$\Delta\phi_{k2} = (26^{\circ}\text{C} - 15,9^{\circ}\text{C}) \cdot \left(123 \frac{\text{W}}{^{\circ}\text{C}} + 21,5 \frac{\text{W}}{^{\circ}\text{C}}\right) = 1460 \text{ W}$$

$$\Delta t_i = \frac{508\text{W} + 1460\text{W}}{21,5 \frac{\text{W}}{^{\circ}\text{C}} + 123 \frac{\text{W}}{^{\circ}\text{C}} + 504 \frac{\text{W}}{^{\circ}\text{C}}} = 3^{\circ}\text{C}$$

$$t_{i,max} = 25,78^{\circ} + \frac{3^{\circ}\text{C}}{2} = 27,28^{\circ}\text{C}$$

To avoid overtemperatures, the necessary airflow would be:

$$5,5^{\circ}\text{C} = 0,5 \left(\frac{\Delta\phi_{k,1} + 12170,5x + 10,1B_t}{B_t + 1206x + B_a} \right) + \frac{\phi_s + \phi_i}{B_t + 1206x}$$

$$5,5 = 0,5 \left(\frac{508 + 12170,5x + 10,1 \cdot 21,5}{21,5 + 1206x + 504} \right) + \frac{617,5 + 145}{21,5 + 1206x}$$



Ligningen løses for x vha. CAS-værktøjet WordMat.

$$x = -3,394861 \quad \vee \quad x = 0,1544408$$

$V_i = 0,154 \frac{\text{m}^3}{\text{s}} = 2,4 \frac{\text{l}}{\text{sm}^2}$ would guarantee a temperature below 26 degrees at the current conditions.

A critical example is the proposal 2 of the leader office, with a maximum temperature of 37 degrees. The formula will be utilized again to investigate the airflow required, and reflect upon if that is realistic.

$$5,5 = 0,5 \left(\frac{369,98 + 12170,5x + 10,1 \cdot 12,65}{12,65 + 1206x + 160} \right) + \frac{514,58 + 46}{12,65 + 1206x}$$



Ligningen løses for x vha. CAS-værktøjet WordMat.

$$x = -0,5215122 \quad \vee \quad x = 0,2552083$$

The required flow of air is $0,255 \frac{\text{m}^3}{\text{s}}$ which is $12,75 \frac{\text{l}}{\text{sm}^2}$. This is quite excessive deemed for the size of the room, and it shows that implementing external solar shading on the windows, which would make the shading factor 0.3 reduces the passive solar gain to 171W rather than 514W, and this puts the maximum temperature at 27,49 under the conditions of ventilating for comfort.

$$5,5 = 0,5 \left(\frac{143,5 + 12170,5x + 10,1 \cdot 12,65}{12,65 + 1206x + 160} \right) + \frac{171 + 46}{12,65 + 1206x}$$



Ligningen løses for x vha. CAS-værktøjet WordMat.

$$x = -1,136486 \quad \vee \quad x = 0,03618883$$

To eliminate the overtemperatures remaining from the external solar shading, the air flow would be $0,036 \frac{\text{m}^3}{\text{s}}$ which is $1,8 \frac{\text{l}}{\text{sm}^2}$.

Operative temperatures:

Predefined conditions:

The temperature of the air is decided to be 22 degrees after appropriate ventilation has been implemented to eliminate overtemperatures, since this is the wished temperature in terms of thermal comfort in summer and winter. All surfaces except for windows and radiators are considered to be the temperature of the internal air.

Surface temperatures:

Radiator: 60 degrees

Window: $T_s = 22^{\circ}\text{C} - 0,13 \frac{^{\circ}\text{C} \cdot \text{m}^2}{\text{W}} \cdot 0,6 \frac{\text{W}}{\text{m}^2 \cdot ^{\circ}\text{C}} \cdot (22^{\circ}\text{C} - (-12^{\circ}\text{C})) = 19,3^{\circ}\text{C}$

$$T_{op} = \frac{T_{ms} + T_i}{2}$$

Operative temperature	8-man office	Single office	Leader office	Meeting room	4-man office
Proposal 1	22,34°C	22,55°C	22,67°C	22,17°C	22,15°C
Proposal 2	22,33°C	22,65°C	22,89°C	22,25°C	22,14°C
Proposal 3	22,33°C	22,65°C	22,81°C	22,16°C	22,30°C
Proposal 4	22,31°C	22,65°C	22,89°C	22,25°C	22,30°C
Proposal 5	22,31°C	22,61°C	22,89°C	22,25°C	22,32°C
Proposal 6	22,31°C	22,47°C	22,89°C	22,25°C	22,32°C

Calculation example, repetitive calculations are not shown:

$$T_{ms} = \sum \psi \cdot T_s$$

Angles are determined from A.01.06 provided at a course introduction at fifth semester BSc arc.

$$\begin{aligned} a_{w1} &= 2m \\ b_{w1} &= 2,8m \\ c_{w1} &= 4m \end{aligned}$$

$$\begin{aligned} \frac{a}{c} &= \frac{2}{4} = 0,5 \\ \frac{b}{c} &= \frac{2,8}{4} = 0,7 \end{aligned}$$

Depicted from chart: $\psi_{w1} = 0,02$

$$\begin{aligned} \psi_{w1} &= 0,02 \\ \psi_{w2} &= 0,01 \\ \psi_{r1} &= 0,01 \\ \psi_{r2} &= 0,01 \end{aligned}$$

$$T_{ms} = (0,02 + 0,01) \cdot 19,3^\circ\text{C} + (0,01 + 0,01) \cdot 60^\circ\text{C} + \{1 - (0,02 + 0,01 + 0,01 + 0,01)\} \cdot 22^\circ\text{C} = 22,67^\circ\text{C}$$

$$T_{op} = \frac{22,67^\circ\text{C} + 22^\circ\text{C}}{2} = 22,335^\circ\text{C}$$

A.01.06. Vinkelforhold mellem personer og flader.

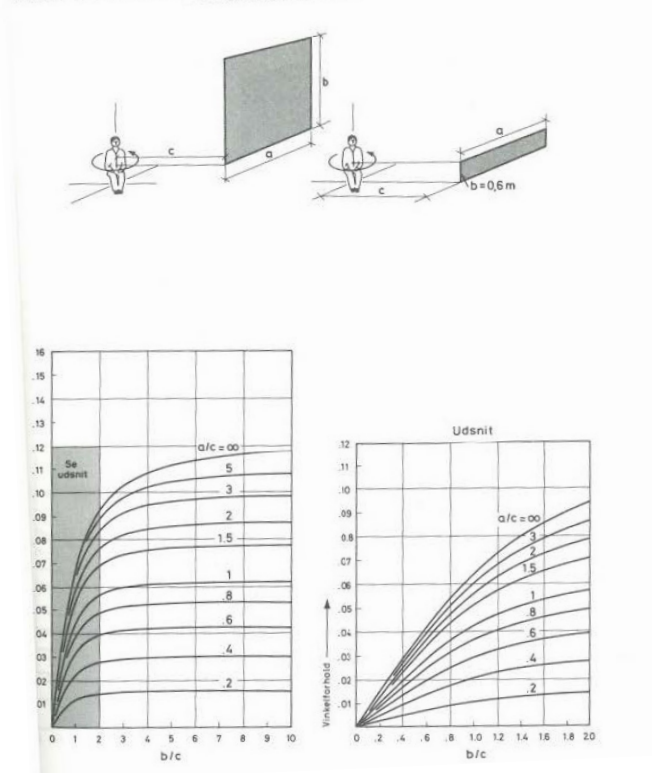

Reverberation time:

In accordance to the calculation of reverberation sound, Sabine's formula will be utilized in coherence with values given at the course "Hygrotermisk bygningsfysik" as was part of the bachelor's educational program.

Sabines formula:

$$R_s = \frac{0,16 \cdot V}{A_a}$$

Example calculation:

Meeting room, 8 people.
30m² with 4m room height.

Volume: 120 m³

Absorption values	Area	125 Hz	250 Hz	500 Hz	1000 Hz	2000 Hz	4000 Hz
Clay surface	96	0,3	0,3	0,2	0,15	0,05	0,05
Glass solid	30	0,18	0,06	0,04	0,03	0,02	0,02
Linoleum	30	0,15	0,11	0,1	0,07	0,06	0,07
Suspended ceiling of plaster / wood	30	0,2	0,15	0,1	0,05	0,05	0,05
Furniture	16	0,6	0,74	0,88	0,96	0,9	0,85
People	8	0,25	0,35	0,42	0,46	0,5	0,5

	125 Hz	250 Hz	500 Hz	1000 Hz	2000 Hz	4000 Hz
Total absorption area	56,3	53	44	52	41,75	43
Reverberation sound	0,34	0,36	0,44	0,37	0,46	0,44

The calculations are repeated with varying areas and people, thus creating various relations between absorption area and volume, inducing varying reverberation sounds in the office spaces.

DGNB SCORING MATRIX

APPENDIX 6

		Actual						
PRO		ENV	ECO	SOC	TEC	SITE	Combined	
		21,68	56,86	51,81	66,32	65,50	70,00	55,41

Number	Indikator	TLP sum	Max	Vægtning	Total sum	Potential	Hjertevægt
Pro 1.1	Kvalitet i forberedelsen af projektet	50	100	3	1,8 %	70	
Pro 1.4	Bæredygtighed i entrepriseudbud	20	140	3	1,8 %	110	
Pro 1.5	Vejledning om vedligehold og brug af bygningen	30	110	2	1,2 %	110	
Pro 1.6	Proces for arkitektonisk kvalitet	80	100	2	1,8 %	100	1
Pro 2.1	Byggeplads/byggeproces	0	110	2	1,2 %	85	
Pro 2.2	Dokumentation af kvalitet i udførelsen	20	120	3	1,8 %	90	3
Pro 2.3	Commissioning	0	110	4	2,4 %	70	
Pro 2.4	Brugerkommunikation	0	100	1	0,6 %	100	1
Pro	Kombineret score	490	2260		12,6 %	1780	

Number	Indikator	TLP sum	Max	Vægtning	Total sum	Potential	Hjertevægt
Env 1.1	Livscyklusvurdering	115	140	8	9,4 %	120	
Env 1.2	Miljøfarlige stoffer	50	170	4	4,7 %	50	2
Env 1.3	Ansvarsbevidst ressourceindvinding	100	100	2	2,3 %	100	
Env 2.2	Drikkevandsforbrug af spildevandsudledning	10	100	2	2,3 %	10	
Env 2.3	Arealanvendelse	90	110	1	1,2 %	90	
Env 2.4	Biodiversitet på matrikel	10	120	2	2,6 %	40	2
Env	Kombineret score	1450	2550		22,5 %	1550	

Number	Indikator	TLP sum	Max	Vægtning	Total sum	Potential	Hjertevægt
Eco 1.1	Totaløkonomi (LCC)	0	110	3	9,6 %	40	
Eco 2.1	Fleksibilitet og tilpasningsevne	115	150	2	6,4 %	125	2
Eco 2.2	Robusthed	100	100	2	6,4 %	100	3
Eco	Kombineret score	430	830		22,4 %	570	

Number	Indikator	TLP sum	Max	Vægtning	Total sum	Potential	Hjertevægt
Soc 1.1	Termisk komfort	80	100	3	3,4 %	80	4
Soc 1.2	Indendørs luftkvalitet	65	100	3	3,4 %	67,5	4
Soc 1.3	Akustisk indeklima	70	100	3	3,1 %	70	4
Soc 1.4	Visuel komfort	87,5	140	3	3,4 %	90	4
Soc 1.6	Kvalitet af udearealer	70	115	2	2,3 %	70	1
Soc 2.1	Universelt design	125	150	3	3,4 %	150	1
Soc 3.2	Bygningsintegreret kunst	0	120	1	1,1 %	35	
Soc 3.3	Plandisponering	68	115	2	2,3 %	75	3
Soc	Kombineret score	1558,5	2350		22,4 %	1697,5	

Number	Indikator	TLP sum	Max	Vægtning	Total sum	Potential	Hjertevægt
Tec 1.1	Brandsikring og sikkerhed	70	90	2	1,9 %	90	
Tec 1.3	Klimaskærmens kvalitet	85	100	3	2,8 %	100	2
Tec 1.4	De tekniske systemers tilpasningsevne	45	100	3	2,8 %	65	
Tec 1.5	Design for vedligehold og rengøringsvenlighed	58,5	110	2	1,9 %	78,5	2
Tec 1.6	Nedtagning og genanvendelse	90	130	3	2,8 %	90	
Tec 1.8	Dokumentation med miljøvaredeklarationer (EPD)	80	100	1	0,9 %	80	
Tec 3.1	Mobilitetsinfrastruktur	55	100	2	1,9 %	55	2
Tec	Kombineret score	1107	1690		15 %	1292	

Number	Indikator	TLP sum	Max	Vægtning	Total sum	Potential	Hjertevægt
Site 1.1	Lokalmiljø	55	90	2	1,3 %	70	1
Site 1.2	Indflydelse på området	85	100	2	1,3 %	85	
Site 1.3	Trafikforbindelser	66	100	2	1,3 %	66	
Site 1.4	Adgang til faciliteter i nærområdet	95	140	2	1,3 %	95	5
Site	Kombineret score	602	860		5,2 %	632	

Potential								
PRO		ENV	ECO	SOC	TEC	SITE	Combined	
		78,76	60,78	68,67	72,23	76,45	73,49	70,37

